

METAL ALTERNATIVES FOR SUSTAINABLE CONSTRUCTION



RAINWATER

CAST IRON

CAST ALUMINIUM

SNAPIT ALUMINIUM

CANOPIES & COPING

DRAINAGE

CAST IRON SIMPLEFIT

CAST IRON LCC SOIL

ROOF DRAINAGE

infinity
RAINWATER SYSTEMS

STAINLESS STEEL

ZINC

COPPER

GALVANISED & ZM STEEL



GUTTERS • DOWNPIPES • DOOR CANOPIES • VERANDAS • CARPORTS • FASCIA & SOFFITS • COPING • AND MORE

NEXT DAY DELIVERY • FREE QUOTES & EXPERT ADVICE • BESPOKE FABRICATION • UNRIVALLED CUSTOMER SERVICE

www.rainclear.co.uk • [0800 644 44 26](tel:08006444426) • sales@rainclear.co.uk

Rainclear Systems Unit 34A, Techno Trading Estate, Ganton Way, Swindon, Wiltshire SN2 8ES

THE UK'S LEADING ONLINE RETAILER
& LARGEST STOCKIST OF METAL
RAINWATER SYSTEMS TO THE TRADE

THE HOME OF METAL GUTTERING



CAST IRON



Heritage Cast

ALUMINIUM



STEEL



COPPER

5

GOOD REASONS TO ORDER FROM RAINCLEAR SYSTEMS

Open 8am – 5pm Mon – Fri

Order by noon for delivery next working day on stocked ranges.



Online ordering – pay securely by credit card or PayPal



Next day delivery on a huge choice of stocked items



FREE delivery on orders of stocked items over £600 net*



Take-off service, quotes and technical advice



Unrivalled customer service

Ask about our
 SATURDAY
and
 SAME DAY
Delivery Services

WAYS TO PAY

WAYS TO ORDER



VISA

PayPal

TRUST PAYMENTS

Apple Pay

Google Pay

Online www.rainclear.co.uk
Freephone 0800 644 44 26
Email sales@rainclear.co.uk
WhatsApp us +447418 310848

* The threshold for made-to-order items is £1,250

CHOOSING THE RIGHT RAINWATER SYSTEM

Need help with choosing the right system?
Call **0800 644 44 26** and take advantage of our knowledgeable team



CAST IRON



ALUMINIUM



ZINC

3

SIMPLE QUESTIONS WILL HELP YOU PICK THE PERFECT SYSTEM FOR YOUR HOME OR PROJECT

1. Is your property modern or heritage style property?

Modern: We recommend Galvanised (or ZM) Steel, Stainless Steel, Copper, Zinc or SnapIT Aluminium.

Traditional heritage style/ Grade 1 or 2 listed: We recommend Cast Aluminium or Cast Iron.

2. Do you live in an area prone to high rainfall?

Send us your architects drawings: Using the roof area, pitch and number of downpipes we can work out all the products you'll need and can give you a quote.

3. What colour do you want?

We stock a wide range of standard colours for next day delivery. A comprehensive range of other colours are available across all our metal ranges. Please send us your enquiry.

NEXT DAY DELIVERY!

ON ALL STOCKED PRODUCTS



Order by noon for next working day delivery



Benefits of Cast Iron

- Properly protected and installed cast iron can last in excess of 100 years!
- Our stocked cast iron rainwater systems, treated with a certified three-coat system, factory-applied under strictly controlled conditions, last up to 10 years before needing to be repainted.
- Cast Iron systems are easy to restore because of the way they are composed of these component parts. Damaged parts can be replaced and slotted into the existing system with a matching 'profile'.











CAST IRON

The cast iron rainwater system is available from stock in a primed finish for onsite painting or a pre-painted black (RAL9005) finish for NEXT DAY DELIVERY. In addition to the stock range the below colour options are available on a 15 working day lead-time, other colours are also available to order* please contact us on 0800 644 44 26.

* A surcharge may be applicable.

Colour Options

RAL 7016M	Anthracite Grey		RAL 3009M	Oxide Red	
RAL 8015M	Chestnut Brown		RAL 3020	Traffic Red	
RAL 9016	White		RAL 5010M	Flower Blue	
RAL 9005	Black	 	RAL 6005M	Moss Green	

Rainclear have put together a range of the most popular sizes and profiles to allow quick availability to its customers. In addition to its stock range, Rainclear can also offer other sizes to match individual project requirements.

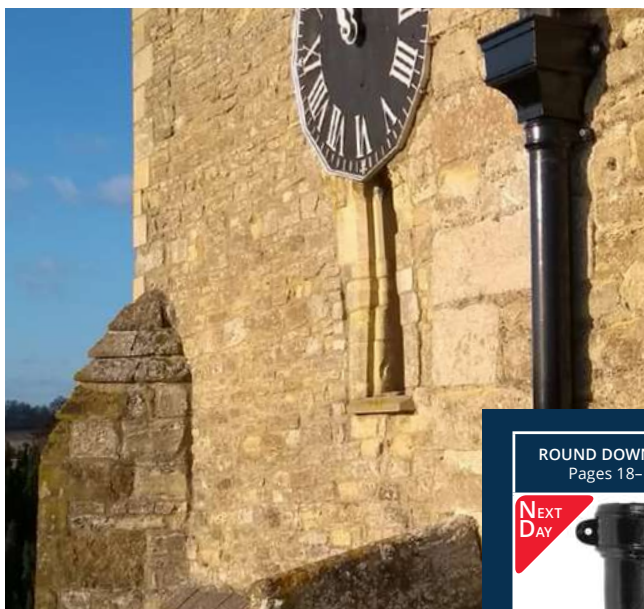

HALF ROUND Pages 6 -7

 NEXT DAY



BEADED HALF ROUND Pages 8 -9



DEEP HALF ROUND Pages 10-11



VICTORIAN OGEE Pages 12 - 13

 NEXT DAY



MOULDED Pages 14-15

 NEXT DAY



ROUND DOWNPIPES Pages 18- 21

 NEXT DAY







SQUARE DOWNPIPES Pages 22 - 23



CAST IRON | HALF ROUND GUTTER & FITTINGS



Description	Size	Primed Code	Primed £	Painted Code	Painted £	
GUTTERS 1.83m (6ft) Length						
	1.83m	100mm (4")	CI4HRG	£71.77	CI4HRGP	£89.06
		115mm (4.5")	CI45HRG	£74.91	CI45HRGP	£91.93
		125mm (5")	CI5HRG	£87.64	CI5HRGP	£108.77
		150mm (6")	CI6HRG	£143.42	CI6HRGP	£185.36
FASCIA BRACKETS						
		100mm (4")	CI4HRFB	£10.61	CI4HRFBP	£12.62
		115mm (4.5")	CI45HRFB	£11.19	CI45HRFBP	£13.17
		125mm (5")	CI5HRFB	£11.73	CI5HRFBP	£13.69
		150mm (6")	CI6HRFB	£12.67	CI6HRFBP	£14.55
STOP ENDS						
	External for Spigot	100mm (4")	CI4HRE1	£10.23	CI4HRE1P	£12.71
		115mm (4.5")	CI45HRE1	£13.02	CI45HRE1P	£16.12
		125mm (5")	CI5HRE1	£13.02	CI5HRE1P	£16.12
		150mm (6")	CI6HRE1	£17.53	CI6HRE1P	£21.77
	Internal for Socket	100mm (4")	CI4HRE2	£10.23	CI4HRE2P	£12.71
		115mm (4.5")	CI45HRE2	£13.02	CI45HRE2P	£16.12
		125mm (5")	CI5HRE2	£13.55	CI5HRE2P	£16.12
		150mm (6")	CI6HRE2	£17.53	CI6HRE2P	£21.77
RUNNING OUTLETS - with Double Socket						
	65mm Round Outlet	100mm (4")	CI4HRRO1	£29.13	CI4HRRO1P	£36.07
		115mm (4.5")	CI45HRRO1	£31.43	CI45HRRO1P	£38.95
		125mm (5")	CI5HRRO1	£41.39	CI5HRRO1P	£45.14
	75mm Round Outlet	100mm (4")	CI4HRRO2	£29.13	CI4HRRO2P	£36.07
		115mm (4.5")	CI45HRRO2	£31.43	CI45HRRO2P	£38.95
		125mm (5")	CI5HRRO2	£36.31	CI5HRRO2P	£45.14
		150mm (6")	CI6HRRO2	£62.83	CI6HRRO2P	£75.71
100mm Round Outlet	150mm (6")	CI6HRRO3	£62.83	CI6HRRO3P	£77.97	



N.B. SPIGOT & SOCKET STOPEND OUTLETS available from stock in sizes: 4", 4.5" & 5" - prices as RUNNING OUTLETS above.

NEXT DAY DELIVERY - order up to noon Mon - Fri for next working day delivery

Description	Size	Primed Code	Primed £	Painted Code	Painted £
90° ANGLES – with Double Socket					
	100mm (4")	CI4HR90A	£30.07	CI4HR90AP	£37.44
	115mm (4.5")	CI45HR90A	£36.53	CI45HR90AP	£45.33
	125mm (5")	CI5HR90A	£45.48	CI5HR90AP	£56.34
	150mm (6")	CI6HR90A	£66.30	CI6HR90AP	£82.24
135° ANGLES – with Double Socket					
	100mm (4")	CI4HR135A	£30.07	CI4HR135AP	£37.44
	115mm (4.5")	CI45HR135A	£36.53	CI45HR135AP	£45.33
	125mm (5")	CI5HR135A	£45.48	CI5HR135AP	£56.34
	150mm (6")	CI6HR135A	£66.30	CI6HR135AP	£82.24
UNION CLIPS					
	100mm (4")	CI4HRU	£19.88	CI4HRUP	£24.55
	115mm (4.5")	CI45HRU	£23.09	CI45HRUP	£29.99
	125mm (5")	CI5HRU	£27.72	CI5HRUP	£34.57
	150mm (6")	CI6HRU	£31.35	CI6HRUP	£38.72
RAFTER BRACKETS TOP FIX – Manufactured in Zinc Plated Steel					
	100mm (4")	TFB4	£7.48	TFB4P	£9.16
	115mm (4.5")	TFB45	£7.88	TFB45P	£9.55
	125mm (5")	TFB5	£8.35	TFB5P	£10.05
	150mm (6")	TFB6	£18.90	TFB6P	£19.88
RAFTER BRACKETS SIDE FIX – Manufactured in Zinc Plated Steel					
	100mm (4")	SFB4	£7.48	SFB4P	£9.16
	115mm (4.5")	SFB45	£7.88	SFB45P	£9.55
	125mm (5")	SFB5	£8.35	SFB5P	£10.05
	150mm (6")	SFB6	£18.90	SFB6P	£19.88
DRIVE IN RISE & FALL BRACKETS – Manufactured in Zinc Plated Steel					
	100mm (4")	RFB4	£16.31	RFB4P	£19.59
	115mm (4.5")	RFB45	£16.31	RFB45P	£19.59
	125mm (5")	RFB5	£16.31	RFB5P	£20.06
	150mm (6")	RFB6	£20.64	RFB6P	£26.77

NEXT DAY DELIVERY – order up to noon Mon – Fri for next working day delivery

CAST IRON | BEADED HALF ROUND GUTTER & FITTINGS



Description	Size	Primed Code	Primed £	Painted Code	Painted £
-------------	------	-------------	----------	--------------	-----------



GUTTERS 1.83m (6ft) Length

	1.83m	115mm (4.5")	CI45BG	£85.19	CI45BGP	£101.96
		125mm (5")	CI5BG	£91.39	CI5BGP	£114.24

FASCIA BRACKETS

		115mm (4.5")	CI45BGFB	£11.96	CI45BGFBP	£14.19
		125mm (4.5")	CI5BGFB	£13.12	CI5BGFBP	£16.34

STOP ENDS

	External for Spigot	115mm (4.5")	CI45BGE1	£15.56	CI45BGE1P	£18.56
		125mm (5")	CI5BGE1	£17.42	CI5BGE1P	£21.77
	Internal for Socket	115mm (4.5")	CI45BGE2	£15.56	CI45BGE2P	£18.56
		125mm (5")	CI5BGE2	£17.42	CI5BGE2P	£21.77

RUNNING OUTLETS – with Double Socket

	65mm Round Outlet	115mm (4.5")	CI45BGRO1	£36.66	CI45BGRO1P	£43.88
		125mm (5")	CI5BGRO1	£39.60	CI5BGRO1P	£49.39
	75mm Round Outlet	115mm (4.5")	CI45BGRO2	£45.87	CI45BGRO2P	£43.88
		125mm (5")	CI5BGRO2	£39.60	CI5BGRO2P	£49.39

N.B. Only stocked for next day delivery in **primed not painted black**

PRIMED = NEXT DAY DELIVERY - order up to noon Mon - Fri for next working day delivery

Description	Size	Primed Code	Primed £	Painted Code	Painted £
-------------	------	-------------	----------	--------------	-----------

90° ANGLES – with Double Socket



115mm (4.5")	CI45BG90A	£33.40	CI45BG90AP	£41.79
125mm (5")	CI5BG90A	£37.85	CI5BG90AP	£47.03

135° ANGLES – with Double Socket



115mm (4.5")	CI45BG135A	£33.40	CI45BG135AP	£41.79
125mm (5")	CI5BG135A	£37.71	CI5BG135AP	£47.03

UNION CLIPS



115mm (4.5")	CI45BGU	£23.65	CI45BGUP	£28.97
125mm (5")	CI5BGU	£27.05	CI5BGUP	£30.38

RAFTER BRACKETS TOP FIX – Manufactured in Zinc Plated Steel



115mm (4.5")	TFB45	£7.88	TFB45P	£9.55
125mm (5")	TFB5	£8.35	TFB45P	£9.55

RAFTER BRACKETS SIDE FIX – Manufactured in Zinc Plated Steel



115mm (4.5")	SFB45	£7.88	SFB45P	£9.55
125mm (5")	SFB5	£8.35	SFB5P	£10.05

DRIVE IN RISE & FALL BRACKETS – Manufactured in Zinc Plated Steel



115mm (4.5")	RFB45	£16.31	RFB45P	£19.59
125mm (5")	RFB5	£16.31	RFB5P	£20.06

CAST IRON | DEEP HALF ROUND GUTTER & FITTINGS



Description	Size	Primed Code	Primed £	Painted Code	Painted £
-------------	------	-------------	----------	--------------	-----------

GUTTERS 1.83m (6ft) Length



1.83m	100 x 75mm (4"x3")	CI43DFG	£84.52	CI43DFGP	£123.99
	125 x 75mm (5"x3")	CI53DFG	£131.93	CI53DFGP	£161.81

FASCIA BRACKETS



	100 x 75mm (4"x3")	CI43DFFB	£22.05	CI43DFFBP	£27.05
	125 x 75mm (5"x3")	CI53DFFB	£25.89	CI53DFFBP	£27.05

STOP ENDS



External for Spigot	100 x 75mm (4"x3")	CI43DFE1	£25.84	CI43DFE1P	£31.69
	125 x 75mm (5"x3")	C53DFE1	£30.31	C53DFE1P	£39.04



Internal for Socket	100 x 75mm (4"x3")	CI43DFE2	£25.84	CI43DFE2P	£31.69
	125 x 75mm (5"x3")	CI53DFE2	£30.31	CI53DFE2P	£39.04

RUNNING OUTLETS – with Double Socket



65mm Round Outlet	100 x 75mm (4"x3")	CI43DFRO1	£71.28	CI43DFRO1P	£92.68
	125 x 75mm (5"x3")	CI53DFRO1	£90.58	CI53DFRO1P	£117.74

75mm Round Outlet	100 x 75mm (4"x3")	CI43DFRO2	£71.28	CI43DFRO2P	£92.68
	125 x 75mm (5"x3")	CI53DFRO2	£90.58	CI53DFRO2P	£117.74

90° ANGLES – RH



	100 x 75mm (4"x3")	CI45DF90A	£71.28	CI45DF90AP	£92.68
	125 x 75mm (5"x3")	CI5DF90A	£90.58	CI5DF90AP	117.74

NEXT DAY DELIVERY – order up to noon Mon – Fri for next working day delivery

Description	Size	Primed Code	Primed £	Painted Code	Painted £
90° ANGLES – LH					
	100 x 75mm (4"x3")	CI43DF90LHA	£71.28	CI43DF90LHAP	£92.68
	125 x 75mm (5"x3")	CI53DF90LHA	£90.58	CI53DF90LHAP	£117.74
135° ANGLES – RH					
	100 x 75mm (4"x3")	CI43DF135RHA	£71.28	CI43DF135RHAP	£92.68
	125 x 75mm (5"x3")	CI53DF135RHA	£90.58	CI53DF135RHAP	£117.74
135° ANGLES – LH					
	100 x 75mm (4"x3")	CI43DF135LHA	£71.28	CI43DF135LHAP	£92.68
	125 x 75mm (5"x3")	CI53DF135LHA	£90.58	CI53DF135LHAP	£117.74
UNION CLIPS					
	100 x 75mm (4"x3")	CI43DFU	£28.03	CI43DFUP	£34.36
	125 x 75mm (5"x3")	CI533DFU	£30.31	CI53DFUP	£37.17
RAFTER BRACKETS TOP FIX – Manufactured in Zinc Plated Steel					
	100 x 75mm (4"x3")	CI43DFTFB	£15.59	CI43DFTFBP	£19.12
	125 x 75mm (5"x3")	CI53DFTFB	£15.86	CI53DFTFBP	£19.43
RAFTER BRACKETS SIDE FIX – Manufactured in Zinc Plated Steel					
	100 x 75mm (4"x3")	CI43DFSFB	£16.81	CI43DFSFBP	£20.60
	125 x 75mm (5"x3")	CI53DFSFB	£17.12	CI53DFSFBP	£20.99
DRIVE IN RISE & FALL BRACKETS – Manufactured in Zinc Plated Steel					
	100 x 75mm (4"x3")	CI43DRFRFB	£19.93	CI43DRFRFBP	POA
	125 x 75mm (5"x3")	CI53DRFRFB	£20.32	CI53DRFRFBP	POA

NEXT DAY DELIVERY – order up to noon Mon – Fri for next working day delivery

CAST IRON | VICTORIAN OGEE GUTTER & FITTINGS

Description	Size	Primed Code	Primed £	Painted Code	Painted £	
GUTTERS 1.83m (6ft) Length						
	1.83m 115mm (4.5")	CI45VG	£88.09	CI45VGP	£109.32	
	125mm (5")	CI5VG	£92.26	CI5VGP	£114.65	
FASCIA BRACKETS						
	115mm (4.5")	CI45VFB	£11.19	CI45VFBP	£13.17	
	125mm (4.5")	CI5VFB	11.73	CI5VFBP	£13.69	
STOP ENDS						
	External Right Hand 115mm (4.5")	CI45VE3	£12.20	CI45VE3P	£15.05	
	125mm (5")	CI5VE3	£13.60	CI5VE3P	£16.85	
	External Left Hand 115mm (4.5")	CI45VE1	£12.20	CI45VE1P	£15.05	
	125mm (5")	CI5VE1	£13.60	CI5VE1P	£16.85	
	Internal Left Hand 115mm (4.5")	CI45VE2	£12.20	CI45VE2P	£15.05	
	125mm (5")	CI5VE2	£13.60	CI5VE2P	£16.85	
RUNNING OUTLETS – with Socket & Spigot						
	65mm Round Outlet	115mm (4.5")	CI45VRO1	£33.86	CI45VRO1P	£41.93
		125mm (5")	CI5VRO1	£36.77	CI5VRO1P	£45.54
	75mm Round Outlet	115mm (4.5")	CI45VRO2	£33.86	CI45VRO2P	£41.93
		125mm (5")	CI5VRO2	£36.77	CI5VRO2P	£45.54
90° ANGLES– with Socket & Spigot						
	External	115mm (4.5")	CI45V90E	£33.86	CI45V90EP	£41.93
		125mm (5")	CI5V90E	£36.77	CI5V90EP	£45.54
	Internal	115mm (4.5")	CI45V90I	£33.86	CI45V90IP	£41.93
		125mm (5")	CI5V90I	£36.77	CI5V90IP	£45.54



Description	Size	Primed Code	Primed £	Painted Code	Painted £	
135° ANGLES – with Socket & Spigot						
	External	115mm (4.5")	CI45V135E	£33.86	CI45V135EP	£41.93
		125mm (5")	CI5V135E	£36.77	CI5V135EP	£45.54
	Internal	115mm (4.5")	CI45V135I	£33.86	CI45V135IP	£41.93
		125mm (5")	CI5V135I	£36.77	CI5V135IP	£45.54
UNION CLIPS						
		115mm (4.5")	CI45VU	£19.88	CI45VUP	£24.55
		125mm (5")	CI5VU	£24.85	CI5VUP	£30.96
RAFTER BRACKETS TOP FIX – Manufactured in Zinc Plated Steel						
		115mm (4.5")	TFBV45	£16.85	TFBV45P	£19.95
		125mm (5")	TFBV5	£17.01	TFBV5P	£19.66
RAFTER BRACKETS SIDE FIX – Manufactured in Zinc Plated Steel						
		115mm (4.5")	SFBV45	£16.85	SFBV45P	£19.09
		125mm (5")	SFBV5	£17.01	SFBV5P	£20.55
DRIVE IN RISE & FALL BRACKETS – Manufactured in Zinc Plated Steel						
		115mm (4.5")	RFBV45	£20.05	RFBV45P	£24.13
		125mm (5")	RFBV5	£20.32	RFBV5P	£24.13
ACCESSORIES						
				See Page 17		

NEXT DAY DELIVERY – order up to noon Mon – Fri for next working day delivery



Description	Size	✓ Primed Code	Primed £	Painted Code	Painted £
GUTTERS 1.83m (6ft) Length					
	1.83m 100 x 75mm (4 x 3")	CI43MGT	£151.69	CI43MGTP	£181.42
	125 x 100mm (5 x 4")	✓ CI54MGT	£212.54	CI54MGTP	£254.36
	150 x 100mm (6 x 4")	CI64MGT	£309.27	CI64MGTP	£386.57
FASCIA BRACKETS					
	100 x 75mm (4 x 3")	CI43MGFB	£15.89	CI43MGFBP	£19.02
	125 x 100mm (5 x 4")	✓ CI54MGFB	£17.62	CI54MGFBP	£21.14
	150 x 100mm (6 x 4")	CI64MGFB	£18.52	CI64MGFBP	£23.06
STOP ENDS					
	External Right Hand 100 x 75mm (4 x 3")	CI43MGE1	£37.26	CI43MGE1P	£44.49
	125 x 100mm (5 x 4")	✓ CI54MGE1	£43.58	CI54MGE1P	£52.18
	150 x 100mm (6 x 4")	CI64MGE1	£55.00	CI64MGE1P	£68.79
	Internal Left Hand 100 x 75mm (4 x 3")	CI43MGE3	£37.26	CI43MGE3P	£44.49
	125 x 100mm (5 x 4")	✓ CI54MGE3	£43.58	CI54MGE3P	£52.18
	150 x 100mm (6 x 4")	CI64MGE3	£55.00	CI64MGE3P	£68.79
	Internal Right Hand 100 x 75mm (4 x 3")	CI43MGE2	£37.26	CI43MGE2P	£44.49
	125 x 100mm (5 x 4")	✓ CI54MGE2	£43.58	CI54MGE2P	£52.18
	150 x 100mm (6 x 4")	CI64MGE2	£55.00	CI64MGE2P	£68.79
RUNNING OUTLETS – with Single Spigot					
	65mm Round Outlet 100 x 75mm (4 x 3")	CI43MGRO1	£87.88	CI43MGRO1P	£105.58
	125 x 100mm (5 x 4")	CI54MGRO1	£127.63	CI54MGRO1P	£141.32
	150 x 100mm (6 x 4")	CI64MGRO1	£153.92	CI64MGRO1P	£192.27
75mm Round Outlet	100 x 75mm (4 x 3")	CI43MGRO2	£87.88	CI43MGRO2P	£105.58
	125 x 100mm (5 x 4")	✓ CI54MGRO2	£127.63	CI54MGRO2P	£152.62
	150 x 100mm (6 x 4")	CI64MGRO2	£153.92	CI64MGRO2P	£192.27
100mm Round Outlet	125 x 100mm (5 x 4")	✓ CI54MGRO3	£127.63	CI54MGRO3P	£152.62
	150 x 100mm (6 x 4")	CI64MGRO3	£153.92	CI64MGRO3P	£192.27

Outlets available with 75 x 75, 100 x 75, 100 x 100 & 125 x 100mm outlets all prices upon application.



Description	Size	✓	Primed Code	Primed £	Painted Code	Painted £
90° ANGLES						
	External	100 x 75mm (4 x 3")	CI43MG90E	£87.88	CI43MG90EP	£105.27
		125 x 100mm (5 x 4")	✓ CI54MG90E	£127.63	CI54MG90EP	£152.62
		150 x 100mm (6 x 4")	CI64MG90E	£153.92	CI64MG90EP	£192.27
	Internal	100 x 75mm (4 x 3")	CI43MG90I	£87.88	CI43MG90IP	£105.27
		125 x 100mm (5 x 4")	✓ CI54MG90I	£127.63	CI54MG90IP	£152.62
		150 x 100mm (6 x 4")	CI64MG90I	£153.92	CI64MG90IP	£192.27
135° ANGLES						
	External	100 x 75mm (4 x 3")	CI43MG135E	£87.88	CI43MG135EP	£105.27
		125 x 100mm (5 x 4")	✓ CI54MG135E	£127.63	CI54MG135EP	£152.62
		150 x 100mm (6 x 4")	CI64MG135E	£153.92	CI64MG135EP	£192.27
	Internal	100 x 75mm (4 x 3")	CI43MG135I	£87.88	CI43MG135IP	£105.27
		125 x 100mm (5 x 4")	✓ CI54MG135I	£127.63	CI54MG135IP	£152.62
		150 x 100mm (6 x 4")	CI64MG135I	£153.92	CI64MG135IP	£192.27
UNION CLIPS						
		100 x 75mm (4 x 3")	CI43MGU	£37.26	CI43MGUP	£44.61
		125 x 100mm (5 x 4")	✓ CI54MGU	£43.58	CI54MGUP	£52.18
		150 x 100mm (6 x 4")	CI64MGU	£55.00	CI64MGUP	£68.79
RAFTER BRACKETS TOP FIX – Manufactured in Zinc Plated Steel						
		100 x 75mm (4 x 3")	TFB43MGT	£34.54	TFB43MGTP	£41.40
		125 x 100mm (5 x 4")	TFB54MGT	£39.10	TFB54MGTP	£46.71
		150 x 100mm (6 x 4")	TFB64MGT	£46.60	TFB64MGTP	£58.24
RAFTER BRACKETS SIDE FIX – Manufactured in Zinc Plated Steel						
		100 x 75mm (4 x 3")	SFB43MGT	£34.54	SFB43MGTP	£43.26
		125 x 100mm (5 x 4")	SFB54MGT	£39.10	SFB54MGTP	£48.82
		150 x 100mm (6 x 4")	SFB64MGT	£46.60	SFB64MGTP	£51.02
DRIVE IN RISE & FALL BRACKETS – Manufactured in Zinc Plated Steel						
		100 x 75mm (4 x 3")	RFB43MGT	£48.70	RFB43MGTP	60.85
		125 x 100mm (5 x 4")	RFB54MGT	£57.74	RFB54MGTP	£72.23
		150 x 100mm (6 x 4")	RFB64MGT	£62.67	RFB64MGTP	81.93

✓ = NEXT DAY DELIVERY – order up to noon Mon – Fri for next working day delivery



HYDROSTRIP CAST IRON GUTTER SEALING SYSTEM

HALF ROUND AND HALF ROUND BEADED GUTTERS ONLY and sizes 100, 115, 125mm and 150mm.



The Hydrostrip system comprises preformed rubber seals that are quick and easy to install, and totally reliable. Hydrostrip offers a faster and cleaner solution to gutter jointing than traditional mastic jointing sealants.

Hydrostrips (order code: GSP) have been a popular replacement to silicone for over half a decade.

Each pack contains 20no rubber strips, 20no M6 x 25 dome head screws and 20no M6 square nuts which are expected, when installed in accordance with the included instructions, to last as long as the system they seal (and longer than the traditional silicone alternative, the thickness and coverage of which can vary and that also needs to 'set' before it becomes watertight).

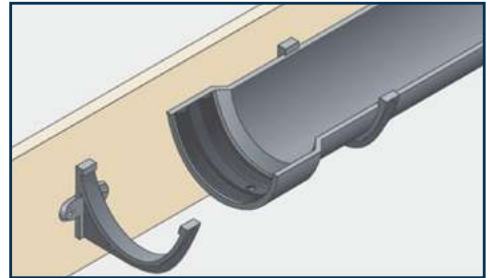

Fig 1. GSP: HYDROSTRIP GUTTER SEALING PACK
(N.B. Not suitable for moulded or ogee profiles)

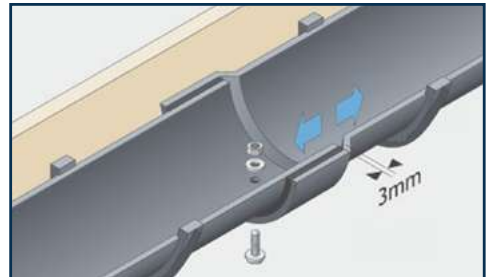

Fig 2. HYDROSTRIP SEALING INSTALL METHOD
Illustration of how the specially designed & tested EPDM rubber strips and screws & nuts go together to seal the gutters where they meet.

	Description	Size		Code	✓	£
	Gutter-Sealing Pack. To join 100, 115, 125 & 150mm half round gutters and fittings (20no).			GSP	✓	£30.08
	Black 310cc Dow Corning Silicone Sealant			791BLACK	✓	£9.98
	125ml Black Touch- Up Paint & Brush			TUP	✓	£9.40
	1Lt Black Touch- Up Paint			TUP1	✓	£26.25
	Fixing Screw: No 10 x 1.5" Roundhead Woodscrew to fix cast iron fascia brackets			SCREW10	✓	£0.11
	M6 x 25mm Zinc Plated Nut/Bolt/Washer to join cast iron beaded gutters			RFBOLT25	✓	£0.13
	Cast Iron Spacer Bobbins To suit all eared downpipes	1/2"	PB-50 5.81	PB-50-PA	✓	£6.45
		3/4"	PB-70 5.81	PB-70-PA	✓	£6.45
		1"	PB-100 6.15	PB-100-PA	✓	£6.85
		1 1/4"	PB-125 6.15	PB-125-PA	✓	£7.43
		1 1/2"	PB-150 6.68	PB-150-PA	✓	£7.43
		1 3/4"	PB-175 6.68	PB-175-PA	✓	£7.43
		2"	PB-200 6.68	PB-200-PA	✓	£8.07
	25mm Wooden Spacer Bobbin to suit all round downpipes			WBOBBIN	✓	£1.10
	100mm (4") long Downpipe Fixing Nail sold individually			DPN	✓	£0.45
	Downpipe Fixing Pack. Contains 20no. 100mm coach screws industrial plugs & washers	100mm (4") long		DPS	✓	£12.31
	Downpipe Fixing Pack. Contains 20no 75mm coach screws, industrial plugs & washers	75mm (3") long		DPS75	✓	£12.08
	Zinc 'stay' to go with all Cast Iron Gutters' Rise & Fall Brackets	13" long		RFBSTAY	✓	£5.25
	Gutter Guard Brush	75mm		BRUSH75	✓	£15.97
		100mm		BRUSH100	✓	£16.79
		125mm		BRUSH125	✓	£19.43
	Gutter Grid Mesh 50mtr Roll c/w 125 clips	For 100mm & 115mm gutters		GRID115	✓	£135.00
		For 125mm gutters		GRID140	✓	£145.00
		For 150mm gutters		GRID155	✓	£160.00



Description	Size	Primed Code	Primed £	Painted Code	Painted £	
ROUND PIPES – with ears						
	65mm (2.5") Round Pipe	1.83m (6FT)	CI25REDP	£136.18	CI25REDPP	£169.17
	75mm (3") Round Pipe	1.83m (6FT)	CI3REDP	£136.18	CI3REDPP	£169.17
	100mm (4") Round Pipe	1.83m (6FT)	CI4REDP	£180.70	CI4REDPP	£224.26
	65mm (2.5") Round Pipe	0.9m (3FT)	CI25REDP09	£113.03	CI25REDP09P	£139.82
	75mm (3") Round Pipe	0.9m (3FT)	CI3REDP09	£113.03	CI3REDP09P	£139.82
	100mm (4") Round Pipe	0.9m (3FT)	CI4REDP09	£139.27	CI4REDP09P	£187.69
ROUND PIPES – without ears						
	65mm (2.5") Round Pipe	1.83m (6FT)	CI25REDPNE	£136.17	CI25REDPNEP	£169.17
	75mm (3") Round Pipe	1.83m (6FT)	CI3REDPNE	£136.17	CI3REDPNEP	£169.17
	100mm (4") Round Pipe	1.83m (6FT)	CI4REDPNE	£180.70	CI4REDPNEP	£224.26
112.5° OFFSETS – without ears						
	55mm (2.5") Round Pipe	76mm Offset	CI25OS75	£63.87	CI25OS75P	£79.24
		114mm Offset	CI25OS115	£63.87	CI25OS115P	£79.24
		152mm Offset	CI25OS150	£63.87	CI25OS150P	£79.24
		228mm Offset	CI25OS225	£74.08	CI25OS225P	£92.05
	55mm (2.5") Round Pipe	304mm Offset	CI25OS305	£86.93	CI25OS305P	£107.94
		381mm Offset	CI25OS380	£173.71	CI25OS380P	£215.93
		457mm Offset	CI25OS455	£203.48	CI25OS455P	£252.97
		533mm Offset	CI25OS535	£254.43	CI25OS535P	£262.87
	55mm (2.5") Round Pipe	609mm Offset	CI25OS610	£254.43	CI25OS610P	£262.87
		685mm Offset	CI25OS685	£352.95	CI25OS685P	£366.22
		762mm Offset	CI25OS765	£431.31	CI25OS765P	£412.74

NEXT DAY DELIVERY – order up to noon Mon – Fri for next working day delivery



Description	Size	Primed Code	Primed £	Painted Code	Painted £	
112.5° OFFSETS – without ears						
	75mm (3") Round Pipe 76mm Offset	CI3OS75	£63.87	CI3OS75P	£79.24	
	114mm Offset	CI3OS115	£63.87	CI3OS115P	£79.24	
	152mm Offset	CI3OS150	£63.87	CI3OS150P	£79.24	
	228mm Offset	CI3OS225	£74.08	CI3OS225P	£92.05	
		304mm Offset	CI3OS305	£86.93	CI3OS305P	£107.94
		381mm Offset	CI3OS380	£173.71	CI3OS380P	£215.93
		457mm Offset	CI3OS455	£203.48	CI3OS455P	£252.97
		533mm Offset	CI3OS535	£254.43	CI3OS535P	£262.87
		609mm Offset	CI3OS610	£254.43	CI3OS610P	£262.87
		685mm Offset	CI3OS685	£352.95	CI3OS685P	£445.37
		762mm Offset	CI3OS765	£431.31	CI3OS765P	£412.74
			76mm Offset	CI4OS75	£120.42	CI4OS75P
114mm Offset	CI4OS115		£120.42	CI4OS115P	£149.61	
152mm Offset	CI4OS150		£120.42	CI4OS150P	£149.61	
228mm Offset	CI4OS225		£154.34	CI4OS225P	£191.85	
	304mm Offset		CI4OS305	£191.78	CI4OS305P	£238.35
	381mm Offset		CI4OS380	£237.00	CI4OS380P	£294.45
	457mm Offset		CI4OS455	£262.03	CI4OS455P	£325.66
	533mm Offset		CI4OS535	£329.93	CI4OS535P	£358.80
	609mm Offset		CI4OS610	£329.93	CI4OS610P	£358.80
	685mm Offset		CI4OS685	£410.32	CI4OS685P	£445.37
	762mm Offset	CI4OS765	£410.32	CI4OS765P	£445.37	
ROUND PIPE SHOES						
	Shoe with ears 65mm (2.5")	CI25SH	£68.15	CI25SHP	£84.58	
	75mm (3")	CI3SH	£68.15	CI3SHP	£84.58	
	100mm (4")	CI4SH	£89.52	CI4SHP	£116.26	
	Shoe without ears 65mm (2.5")	CI25SHNE	£68.15	CI25SHNEP	£84.99	
	75mm (3")	CI3SHNE	£68.15	CI3SHNEP	£84.99	
	100mm (4")	CI4SHNE	£93.54	CI4SHNEP	£116.26	



Description	Size	✓	Primed Code	Primed £	Painted Code	Painted £
BENDS – without ears						
	92.5° 65mm (2.5")	✓	CI25B90	£41.54	CI25B90P	£51.63
	75mm (3")	✓	CI3B90	£50.45	CI3B90P	£62.40
	100mm (4")	✓	CI4B90	£71.54	CI4B90P	£87.26
	112.5° 65mm (2.5")	✓	CI25B112	£41.54	CI25B112P	£51.63
	75mm (3")	✓	CI3B112	£50.45	CI3B112P	£62.40
	100mm (4")	✓	CI4B112	£71.54	CI4B112P	£87.26
	135° 65mm (2.5")	✓	CI25B135	£41.54	CI25B135P	£51.63
	75mm (3")	✓	CI3B135	£50.45	CI3B135P	£62.37
	100mm (4")	✓	CI4B135	£71.54	CI4B135P	£87.26
BRANCHES – without ears						
	Pipe without ears 112.5° 65mm (2.5")	✓	CI25J	£67.24	CI25JP	£66.89
	75mm (3")	✓	CI3J	£74.08	CI3JP	£73.28
	100mm (4")	✓	CI4J	£88.20	CI4JP	£86.20
ACCESS PIPES – with ears						
	400mm long 65mm (2.5")	✓	CI25AP	£161.32	CI25APP	£171.21
	75mm (3")	✓	CI3AP	£161.32	CI3APP	£171.21
	100mm (4")		CI4AP*	£213.89	CI4APP*	£245.99
SOCKETS						
	Socket with ears 65mm (2.5")	✓	CI25ES	£24.84	CI25ESP	£30.90
	75mm (3")	✓	CI3ES	£24.84	CI3ESP	£30.90
	100mm (4")	✓	CI4ES	£33.60	CI4ESP	£41.70
	Socket without ears 65mm (2.5")	✓	CI25SOCNE †	£31.25	CI25SOCNEP †	£31.25
	75mm (3")	✓	CI3SOCNE †	£24.84	CI3SOCNEP †	£31.25
	100mm (4")	✓	CI4SOCNE †	£33.60	CI4SOCNEP †	£41.70

† Only Primed versions stocked for next day delivery
Painted versions available for delivery in 10 days.

* Primed versions available for delivery in 5 days.
Painted versions available for delivery in 10 days.

✓ = NEXT DAY DELIVERY – order up to noon Mon – Fri for next working day delivery

Description	Size	✓	Primed Code	Primed £	Painted Code	Painted £	
RAINWATER HOPPER HEADS							
	Fluted Flat Back	65mm (2.5")	✓	CI25HO1	£91.67	CI25HO1P	£109.01
		75mm (3")	✓	CI3HO1	£91.67	CI3HO1P	£109.01
		100mm (4")	✓	CI4HO1	£129.59	CI4HO1P	£157.63
	Fluted Corner	65mm (2.5")	✓	CI25HO4	£134.78	CI25HO4P	£173.52
		75mm (3")	✓	CI3HO4	£134.78	CI3HO4P	£173.52
		100mm (4")	✓	CI4HO4	£176.50	CI4HO4P	£209.99
	Rectangular Small 250 x 178 x 178mm	65mm (2.5")	✓	CI25HO2	£144.98	CI25HO2P	£179.93
		75mm (3")	✓	CI3HO2	£144.98	CI3HO2P	£179.93
		100mm (4")	✓	CI4HO2	£175.23	CI4HO2P	£201.13
	Rectangular Large 305 x 254 x 203mm	65mm (2.5")	✓	CI25HO3	£192.74	CI25HO3P	£230.43
		75mm (3")	✓	CI3HO3	£192.74	CI3HO3P	£230.43
		100mm (4")	✓	CI4HO3	£245.09	CI4HO3P	£293.19
DRIVE-IN PIPE SUPPORT BRACKET							
		65mm (2.5")	✓	CI25HF	£13.20	CI25HFP	£13.93
		75mm (3")	✓	CI3HF	£13.20	CI3HFP	£13.93
RAINWATER DIVERTER							
	We stock with divert to the left hand-side as shown (RH divert available to order)	65mm (2.5")	✓	CI25RADIV	£111.14	CI25RADIVP	£123.60
		75mm (3")	✓	CI3RADIV	£111.14	CI3RADIVP	£123.60
ROUND DOWNPIPE CLIP							
		65mm (2.5")	✓	CI25DPC	£23.45	CI25DPCP	£30.35
	Manufactured in zinc plated steel.	75mm (3")	✓	CI3DPC	£27.24	CI3DPCP	£35.36
		100mm (4")	✓	CI4DPC	£38.63	CI4DPCP	£50.06
ORNATE RAINWATER HOPPER HEADS							

Find the prices for these more ornate Cast Iron hoppers on our website or give us a call.



RH11



RH12



RH42



RH55



RH58



RH100





RH169

POA



Description	Size	Code	£
4 X 3" SQUARE DOWNPIPE - with Eared Socket			
	100 x 75mm	P433FT	£369.68
	100 x 75mm	P433FTPA	£370.72
	100 x 75mm	P436FT	£492.90
	100 x 75mm	P436FTPA	£510.09

Description	Size	Code	£
4 X 3" SQUARE DOWNPIPE - without Ears			
	100 x 75mm	P433FTNE	£365.17
	100 x 75mm	P433FTNEPA	£366.20
	100 x 75mm	P436FTNE	£499.59
	100 x 75mm	P436FTNEPA	£500.98

Description	Size	Code	£
4 X 3" SQUARE DOWNPIPE SOCKET - with Ears			
	100 x 75mm	P43SOC	£200.91
	100 x 75mm	P43SOCPA	£201.47

Description	Size	Code	£
120° SWAN NECK - 76, 114, 152, 228 & 304mm			
	100 x 75mm	P43OF03	£234.76
	100 x 75mm	P43OF03PA	£235.43
	100 x 75mm	P43OF04	£252.97
	100 x 75mm	P43OF04PA	£253.66
	100 x 75mm	P43OF06	£252.97
	100 x 75mm	P43OF06PA	£253.66
	100 x 75mm	P43OF09	£331.97
	100 x 75mm	P43OF09PA	£332.90
	100 x 75mm	P43OF12	£355.87
100 x 75mm	P43OF12PA	£356.89	

The suffix 'PA' refers to the pre-painted black version. The code without suffix refers to the primed version.

Description	Size	Code	£
135° PLINTH OFFSET - 76mm, 114 & 152mm			
	100 x 75mm	P43OF03PE	£276.10
	100 x 75mm	P43OF03PEPA	£276.83
	100 x 75mm	P43OF04PE	£297.62
	100 x 75mm	P43OF04PEPA	£298.44
	100 x 75mm	P43OF06PE	£297.62
	100 x 75mm	P43OF06PEPA	£298.44

Description	Size	Code	£
Branch 112.5° - with Ears - Left or Right Hand			
	100 x 75mm	P43BR112LE	£401.21
	100 x 75mm	P43BR112LEPA	£420.46
	100 x 75mm	P43BR112RE	£401.21
	100 x 75mm	P43BR112REPA	£420.46

Description	Size	Code	£
BEND - 112.5° Bend to left or right			
	100 x 75mm	P43B112LE	£190.30
	100 x 75mm	P43B112LEPA	£199.39
	100 x 75mm	P43B112RE	£190.30
	100 x 75mm	P43B112REPA	£199.39

Description	Size	Code	£
ACCESS PIPE - WITHOUT EARS			
	100 x 75mm	P43AP	£391.76
	100 x 75mm	P43APPA	£392.83

Description	Size	Code	£
SHOE - FRONT with & without Ears			
	100 x 75mm	P43SH	£247.57
	100 x 75mm	P43SHPA	£244.83
	100 x 75mm	P43SHE	£244.15
	100 x 75mm	P43SHEPA	£248.25











CAST IRON | SQUARE SOCKETED DOWNPIPES

In addition to the stock range **SQUARE DOWNPIPES** are available in the below colour options and on a **15 working day lead-time**

Other RAL & BS colours are also available to order but surcharges will apply. Please contact us on 0800 644 44 26.

Colour Options

RAL 7016M	Anthracite Grey		RAL 3009M	Oxide Red	
RAL 8015M	Chestnut Brown		RAL 3020	Traffic Red	
RAL 9005	Black		RAL 5010M	Flower Blue	
RAL 9016	White		RAL 6005M	Moss Green	

Rainclear have put together a range of the most popular sizes and profiles to allow quick availability to its customers. In addition to its stock range, Rainclear can also offer other sizes to match individual project requirements.



SQUARE DOWNPIPES



Delivery in 15 Days

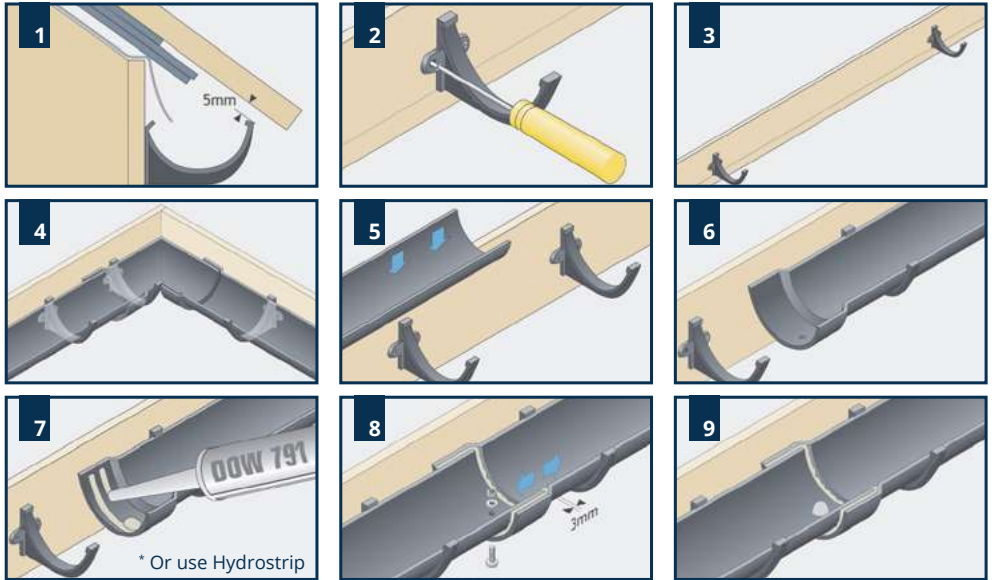

For half round gutters only, the Rainclear Hydrostrip system is recommended. The Hydrostrip system comprises preformed rubber seals that are quick and easy to install, and totally reliable.

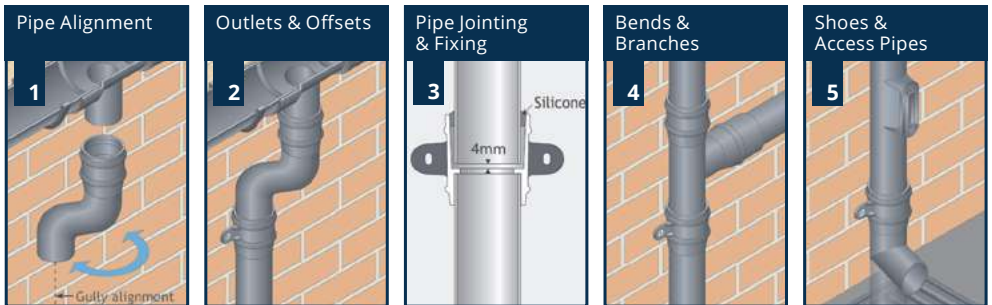

You can download full installation guide PDFs from our website at: rainclear.info/ci-inst





CAST IRON | SYSTEM COMPONENTS



Fixed Offsets: 76mm, 114mm, 152mm, 228mm, 304mm, 381mm, 457mm, 533mm, 609mm, 685mm or 762mm



NEXT DAY DELIVERY!





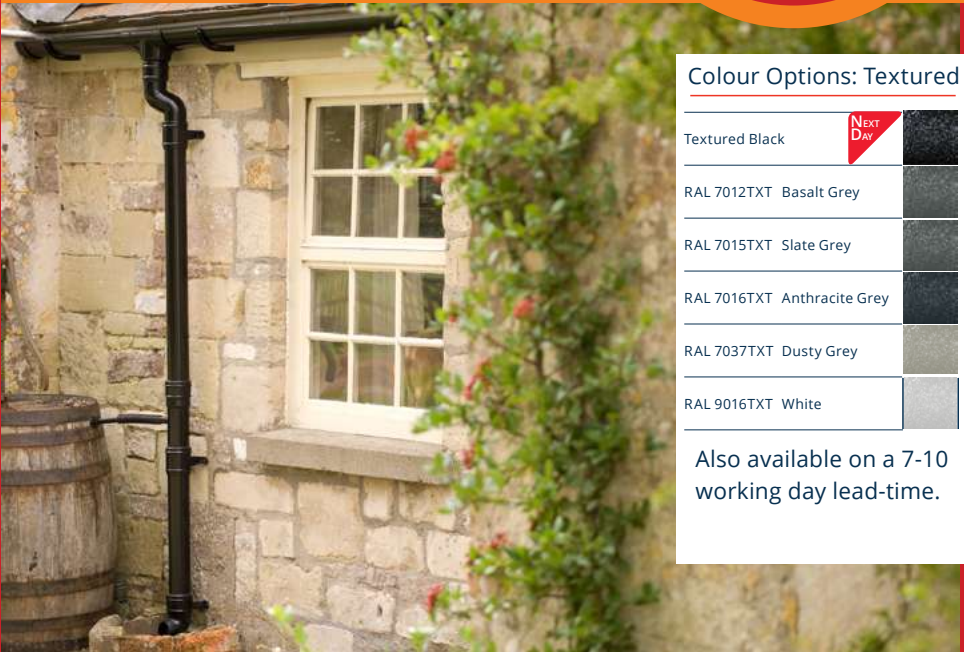

ON ALL STOCKED PRODUCTS



Order by noon for next working day delivery



Colour Options: Textured

Textured Black		
RAL 7012TXT Basalt Grey		
RAL 7015TXT Slate Grey		
RAL 7016TXT Anthracite Grey		
RAL 7037TXT Dusty Grey		
RAL 9016TXT White		

Also available on a 7-10 working day lead-time.

Benefits of Cast Aluminium

- Traditional cast gutters
- Corrosion resistant, lightweight and durable
- Factory applied Powder coated colour
- Low maintenance
- Easy to install

Rainclear have put together a range of the most popular sizes and profiles to allow quick availability to its customers.

In addition to its stock range, Rainclear can also offer other sizes to match individual project requirements.



CAST ALUMINIUM

Rainclear's cast aluminium rainwater system emulates the original features of traditional cast iron making it an ideal choice for sympathetic restoration and new build projects where traditional character is required.

Available from stock in a textured black powder coated finish and in any of the below standard RAL matt or textured colours a 7-10 working day lead-time..

Contact us on 0800 644 44 26 for Plain Mill Finish (unpainted) or to request a free colour swatch.

Colour Options:

RAL 1013M	Pearl White		RAL 7024M	Graphite Grey	
RAL 1035MET	Pearl Beige Metallic		RAL 7032M	Pebble Grey	
RAL 3012M	Beige Red		RAL 7035M	Light Grey	
RAL 6005M	Moss Green		RAL 7037M	Dusty Grey	
RAL 7002M	Olive Grey		RAL 7038M	Agate Grey	
RAL 7004M	Signal Grey		RAL 7040M	Window Grey	
RAL 7005M	Mouse Grey		RAL 8014M	Sepia Brown	
RAL 7006M	Beige Grey		RAL 8017M	Chocolate Brown	
RAL 7012M	Basalt Grey		RAL 8019M	Grey Brown	
RAL 7015M	Slate Grey		RAL 9005M	Jet Black	
RAL 7016M	Anthracite Grey		RAL 9006M	Metallic Silver	
RAL7021M	Black Grey		RAL 9010M	Pure White	
RAL 7022M	Umbra Grey		RAL 9016M	White	
RAL 9017M	Textured Black		RAL 9017M	Black	
RAL 7012TXT	Basalt Grey		<p>Colours are reproduced for general guidance only. For exact colour and finish references please contact Rainclear for colour swatch samples and for further information.</p>		
RAL 7015TXT	Slate Grey				
RAL 7016TXT	Anthracite Grey				
RAL 7037TXT	Dusty Grey				
RAL 9016TXT	White				

HALF ROUND
Pages 28 - 29

NEXT DAY



VICTORIAN OGEE
Pages 30 - 31

NEXT DAY



MOULDED
Pages 32 - 33

NEXT DAY



BEADED HALF ROUND
Page 34



BEADED DEEP RUN
Page 35

NEXT DAY



SOCKETED ROUND
DOWNPIPES
Pages 38 - 39

NEXT DAY



SOCKETED SQUARE
DOWNPIPES
Pages 40 - 41





Description	Size	Code	✓	£
HALF ROUND GUTTER 1.83M				
	100mm	AL4HRG	✓	£98.63
	115mm	AL45HRG	✓	£103.29
	125mm	AL5HRG	✓	£116.03
	150mm	AL6HRG	✓	£161.18

Description	Size	Code	✓	£
HALF ROUND FASCIA BRACKET				
	100mm	AL4HRFB	✓	£7.82
	115mm	AL45HRFB	✓	£7.97
	125mm	AL5HRFB	✓	£14.59
	150mm	AL6HRFB	✓	£23.43

Description	Size	Code	✓	£
EXTERNAL STOP END for fitting over spigot end				
	100mm	AL4HRE1	✓	£14.66
	115mm	AL45HRE1	✓	£15.39
	125mm	AL5HRE1	✓	£18.75
	150mm	AL6HRE1	✓	£21.41

Description	Size	Code	✓	£
INTERNAL STOP END for fitting into socket end				
	100mm	AL4HRE2	✓	£14.66
	115mm	AL45HRE2	✓	£15.39
	125mm	AL5HRE2	✓	£18.75
	150mm	AL6HRE2	✓	£23.88

Description	Size	Code	✓	£
RUNNING OUTLET for 63mm downpipe				
	100mm	AL4HRRO1	✓	£30.00
	115mm	AL45HRRO1	✓	£35.31
	125mm	AL5HRRO1	✓	£38.23
	150mm	AL6HRRO1	✓	£50.32

Description	Size	Code	✓	£
RUNNING OUTLET for 76mm downpipe				
	100mm	AL4HRRO2	✓	£30.00
	115mm	AL45HRRO2	✓	£35.31
	125mm	AL5HRRO2	✓	£38.23
	150mm	AL6HRRO2	✓	£50.32

Description	Size	Code	✓	£
RUNNING OUTLET for 100mm downpipe				
	125mm	AL5HRRO3	✓	£38.23
	150mm	AL6HRRO3	✓	£50.32

Description	Size	Code	✓	£
SOCKET OUTLET for 63mm downpipe				
	100mm	AL4SOC01	✓	£28.82
	115mm	AL45SOC01	✓	£30.63
	125mm	AL5SOC01	✓	£35.11

Description	Size	Code	✓	£
SOCKET OUTLET for 76mm downpipe				
	125mm	AL5SOC02	✓	£32.50

Description	Size	Code	✓	£
SPIGOT OUTLET for 63mm downpipe				
	100mm	AL4SPO1	✓	£28.82
	115mm	AL45SPO1	✓	£33.09
	125mm	AL5SPO1	✓	£35.11

Description	Size	Code	✓	£
SPIGOT OUTLET for 76mm downpipe				
	125mm	AL5SPO2	✓	£35.11

Description	Size	Code	✓	£
90° EXTERNAL ANGLE				
	100mm	AL4HR90E	✓	£29.93
	115mm	AL45HR90E	✓	£33.72
	125mm	AL5HR90E	✓	£37.46
	150mm	AL6HR90E	✓	£49.77

Description	Size	Code	✓	£
90° INTERNAL ANGLE				
	100mm	AL4HR90I	✓	£29.93
	115mm	AL45HR90I	✓	£33.72
	125mm	AL5HR90I	✓	£37.46
	150mm	AL6HR90I	✓	£49.77

Description	Size	Code	✓	£
135° INTERNAL ANGLE				
	100mm	AL4HR135I	✓	£29.93
	115mm	AL45HR135I	✓	£33.72
	125mm	AL5HR135I	✓	£37.46
	150mm	AL6HR135I	✓	£49.77

Description	Size	Code	✓	£
135° EXTERNAL ANGLE				
	100mm	AL4HR135E	✓	£29.93
	115mm	AL45HR135E	✓	£33.72
	125mm	AL5HR135E	✓	£37.46
	150mm	AL6HR135E	✓	£49.77

Description	Size	Code	✓	£
GUTTER UNION				
	100mm	AL4HRU	✓	£14.66
	115mm	AL45HRU	✓	£15.39
	125mm	AL5HRU	✓	£18.75
	150mm	AL6HRU	✓	£23.88

Description	Size	Code	✓	£
RISE & FALL BRACKET c/w SPIKE				
	100mm	AL4RFB	✓	£27.40
	115mm	AL45RFB	✓	£27.81
	125mm	AL5RFB	✓	£28.35
	150mm	AL6RFB	✓	£34.28

Description	Size	Code	✓	£
SIDE FIX RAFTER BRACKET				
	100mm	AL4SFB	✓	£14.00
	115mm	AL45SFB	✓	£14.00
	125mm	AL5SFB	✓	£14.00
	150mm	AL6SFB	✓	£21.80

Description	Size	Code	✓	£
TOP FIX BRACKET				
	100mm	AL4TFB	✓	£14.00
	115mm	AL45TFB	✓	£14.00
	125mm	AL5TFB	✓	£14.00
	150mm	AL6TFB	✓	£21.80

✓ = NEXT DAY DELIVERY - order up to noon Mon - Fri for next working day delivery



Description	Size	Code	✓	£
GUTTER 1.83m (6ft) length				
	115mm	AL45VG	✓	£136.80
	125mm	AL5VG	✓	£151.09

FASCIA BRACKET				
	115mm	AL45VFB	✓	£16.48
	125mm	AL5VFB	✓	£18.10

EXTERNAL STOP END (right)				
	115mm	AL45VE1	✓	£16.48
	125mm	AL5VE1	✓	£18.10

INTERNAL STOP END (left)				
	115mm	AL45VE2	✓	£16.48
	125mm	AL5VE2	✓	£18.10

RUNNING OUTLET (for 63mm downpipe)				
	115mm	AL45VRO1	✓	£38.44
	125mm	AL5VRO1	✓	£42.00

RUNNING OUTLET (for 76mm downpipe)				
	115mm	AL45VRO2	✓	£38.44
	125mm	AL5VRO2	✓	£42.00

Description	Size	Code	✓	£
STOP END OUTLET right (for 63mm downpipe)				
	115mm	AL45VSOCO1	✓	£32.96
	125mm	AL5VSOCO1	✓	£37.46

STOP END OUTLET right (for 76mm downpipe)				
	125mm	AL5VSOCO2	✓	£37.46

STOP END OUTLET left (for 63mm downpipe)				
	115mm	AL45VSP01	✓	£33.09
	125mm	AL5VSP01	✓	£37.46

STOP END OUTLET left (for 76mm downpipe)				
	125mm	AL5VSP02	✓	£37.46

90° EXTERNAL ANGLE				
	115mm	AL45V90E	✓	£38.15
	125mm	AL5V90E	✓	£44.49

90° INTERNAL ANGLE				
	115mm	AL45V90I	✓	£38.15
	125mm	AL5V90I	✓	£44.49

✓ = NEXT DAY DELIVERY – order up to noon Mon – Fri for next working day delivery



CAST ALUMINIUM |

Description	Size	Code	✓	£
135° EXTERNAL ANGLE				
	115mm	AL45V135E	✓	£38.15
	125mm	AL5V135E	✓	£44.49

135° INTERNAL ANGLE				
	115mm	AL45V135I	✓	£38.15
	125mm	AL5V135I	✓	£44.49

GUTTER UNION				
	115mm	AL45VU	✓	£16.48
	125mm	AL5VU	✓	£19.38

ACCESSORIES





See Page 37



VICTORIAN OGEE



Description	Size	Code	✓	£
GUTTER 1.83M				
	125x100mm	AL54MGT	✓	£200.04
	100x75mm	AL43MGT		£164.48

FASCIA BRACKET				
	25x100mm	AL54MGFB	✓	£26.37
	100x75mm	AL43MGFB		£22.36

RIGHT HAND INTERNAL STOP END				
	125x100mm	AL54MGE2	✓	£26.37
	100x75mm	AL43MGE2		£22.36

LEFT HAND EXTERNAL STOP END				
	125x100mm	AL54MGE3	✓	£26.37
	100x75mm	AL43MGE3		£22.36

Description	Size	Code	✓	£
GUTTER OUTLET 100mm				
	125x100mm	AL54MGRO3	✓	£51.77

GUTTER OUTLET 76mm				
	125x100mm	AL54MGRO2	✓	£51.77
	100x75mm	AL43MGRO2		£85.57

GUTTER OUTLET 63mm				
	125x100mm	AL54MGRO1	✓	£51.77
	100x75mm	AL43MGRO1		£36.55

GUTTER SUPPORT BRACKET - Plain Milled				
		AL54MGSB	✓	£5.08
		(mill finish only)		



* 100x75mm size is available in 15 days
 NB. Rectangular/square spigot outlets also available





CAST ALUMINIUM |

Description	Size	Code	✓	£
90° EXTERNAL ANGLE				
	125x100mm	AL54MG90E	✓	£46.43
	100x75mm	AL43MG90E		£32.35

Description	Size	Code	✓	£
RISE & BRACKET				
	125x100mm	AL54MGRFB	✓	£34.80
	100x75mm	AL43MGRFB		£30.87







Description	Size	Code	✓	£
90° INTERNAL ANGLE				
	125x100mm	AL54MG90I	✓	£46.43
	100x75mm	AL43MG90I		£32.35

Description	Size	Code	✓	£
SIDE FIX RAFTER BRACKET				
	125x100mm	AL54MGSFB	✓	£20.22
	100x75mm	AL43MGSFB		£20.20

Description	Size	Code	✓	£
135° EXTERNAL ANGLE				
	125x100mm	AL54MG135E	✓	£46.43
	100x75mm	AL43MG135E		£32.35

Description	Size	Code	✓	£
TOP FIX BRACKET				
	125x100mm	AL54MGTFB	✓	£20.22
	100x75mm	AL43MGTFB		£20.20

Description	Size	Code	✓	£
135° INTERNAL ANGLE				
	125x100mm	AL54MG135I	✓	£46.43
	100x75mm	AL43MG135I		£32.35

ACCESSORIES		
		
		
See Page 37		

Description	Size	Code	£
GUTTER UNION			
	125x100mm	AL54MGU	£23.65
	100x75mm	AL43MGU	£20.05

✓ = NEXT DAY DELIVERY - order up to noon Mon - Fri for next working day delivery



Description	Size	Code	£	Description	Size	Code	£
HALF ROUND GUTTER				STOPEND OUTLET for 63mm downpipe			
	115mm (4 1/2")	BHR5_300	£125.88		115mm (4 1/2")	BHR5_RO25SE	£74.89
	115mm (4 1/2")	BHR5_303	£53.66	STOPEND OUTLET for 75mm downpipe			
HALF ROUND FASCIA BRACKET					115mm (4 1/2")	BHR5_RO30SE	£74.89
	115mm (4 1/2")	BHR5_315	£15.30	STOPEND OUTLET for 75x75mm downpipe			
EXTERNAL STOP END for fitting over spigot end					115mm (4 1/2")	BHR5_RO33SE	£74.89
	115mm (4 1/2")	BHR5_306	£23.22	90° EXTERNAL ANGLE			
INTERNAL STOP END for fitting into socket end					115mm (4 1/2")	BHR5_311	£43.11
	115mm (4 1/2")	BHR5_318	£23.22	90° INTERNAL ANGLE			
DOUBLE SOCKET OUTLET for 63mm downpipe					115mm (4 1/2")	BHR5_310	£43.11
	115mm (4 1/2")	BHR5_304	£44.89	90° COMBINED ANGLE			
DOUBLE SOCKET OUTLET for 75mm downpipe					115mm (4 1/2")	BHR5_309	£43.11
	115mm (4 1/2")	BHR5_307	£44.89	135° EXTERNAL ANGLE			
DOUBLE SOCKET OUTLET for 75x75mm downpipe					115mm (4 1/2")	BHR5_EA135	£74.89
	115mm (4 1/2")	BHR5_384	£74.89	135° INTERNAL ANGLE			
SPIGOT/SOCKET OUTLET for 63mm downpipe					115mm (4 1/2")	BHR5_IA135	£74.89
	115mm (4 1/2")	BHR5_305	£44.89	135° COMBINED ANGLE			
SPIGOT/SOCKET OUTLET for 75mm downpipe					115mm (4 1/2")	BHR5_IA135D	£85.78
	115mm (4 1/2")	BRH5_308	£44.89	GUTTER UNION			
SPIGOT/SOCKET OUTLET for 75x75mm downpipe					115mm (4 1/2")	BHR5_UC	£23.17
	115mm (4 1/2")	BRH5_SO33	£74.89				



CAST ALUMINIUM | BEADED DEEP RUN

Description	Size	Code	✓	£	Description	Size	Code	✓	£
HALF ROUND GUTTER 1.83M					90° EXTERNAL ANGLE				
	115x75mm (4.5x3")	AL43DFG	✓	£175.17		115x75mm (4.5x3")	AL43DF90E	✓	£78.95
HALF ROUND FASCIA BRACKET					90° INTERNAL ANGLE				
	115x75mm (4.5x3")	AL43DFGRB	✓	£31.55		115x75mm (4.5x3")	AL43DF90I	✓	£78.95
EXTERNAL STOP END for fitting over spigot end					135° EXTERNAL ANGLE				
	115x75mm (4.5x3")	AL43DFE1	✓	£31.55		115x75mm (4.5x3")	AL43DF135E	✓	£127.78
INTERNAL STOP END for fitting into socket end					135° INTERNAL ANGLE				
	115x75mm (4.5x3")	AL43DFE2	✓	£31.55		115x75mm (4.5x3")	AL43DF135I	✓	£127.78
DOUBLE SOCKET OUTLET for 63mm downpipe					GUTTER UNION				
	115x75mm (4.5x3")	AL43DFRO1	✓	£75.01		115x75mm (4.5x3")	AL43DFGU	✓	£26.33
DOUBLE SOCKET OUTLET for 76mm downpipe									
	115x75mm (4.5x3")	AL43DFRO2	✓	£123.88					

All standard RAL colours are available on a 7-15 working day lead-time (see page 26 for textured colours and page 27 for Standard Matt RAL colours).

For Plain Mill Finish (unpainted) call us on 0800 644 44 26



The Hydrostrips for Cast iron have been a popular replacement to silicone for over half a decade, and Metseal now offers the same solution for cast aluminium.



- The Metseal rubber seal has been specially developed for use with cast aluminium half round gutters
- Suitable for use with Half Round profile in 100, 115, 125 and 150mm
- The pack comes with 20 rubber seals plus associated nuts, bolts and washers.
- Supplied with 3 year's manufacturer's warranty (see pack for details)



Fig 1. Illustration of how the specially designed & tested EPDM rubber strips seal the gutter lengths where they join.



Fig 2. Powder Coated Anthracite Grey Cast Aluminium gutters along with some unusual angles (pictured) for which Rainclear arranged bespoke fabrication.

Downpipe Fixing Pack for Aluminium
Ordering Code: DPS40















For fixing the Cast Aluminium Eared downpipes use either our Screw20: a single No 12 sized, 2 inch screw & washer or our DPS40: Downpipe 'Fixing Pack' (Pack Contents: 20 x 40mm hex screws, washers, rawl plugs & caps) with either option you use 2no per eared socket.

For fixing the Aluminium Pipe Clip: use either Screw20 or DPS40 and 2no per clip.





CAST ALUMINIUM GUTTERING |

Description	Size	Code	✓	£
 Metseal Cast Aluminium Gutter Sealing pack	100, 115, 125 & 150mm half round cast aluminium gutters	METSEAL	✓	£39.03
 Silicone Sealant	Black 310cc Dow Corning Silicone	791BLACK	✓	£9.98
 Black Touch Up Paint & Brush	125ml	ALTUP	✓	£9.98
 Aluminium Jointing Nut/Bolt/Washer	M6 x 20mm to join Aluminium gutters with silicone sealant	ALBOLT20	✓	£0.28
 Fast Drying Solvent Cleaner	500ml	SOLCLEN	✓	£10.02
 Downpipe Socket Filler Foam	10m x 6mm	BFOAM	✓	5.52
 Roundhead Screw & Washer	No 12 x 2"	SCREW20	✓	£0.12
 Roundhead Screw & Washer	No 12 x 1.5"	SCREW15	✓	£0.12
 Downpipe Fixing Pack for Aluminium	20 x 40mm hex screws, washers, wall plugs & caps	DPS40	✓	£12.83
 Wedge for Direct Fixing Victorian Ogee Gutters		VOWEDGE	✓	£6.69
 Wedge for Direct Fixing Moulded Ogee Gutters		MOWEDGE	✓	£9.10
 Gutter Guard Brush	75mm	BRUSH75	✓	£15.97
	100mm	BRUSH100	✓	£16.79
	125mm	BRUSH125	✓	£19.43
 Gutter Grid Mesh	For 100mm & 115mm gutters	GRID115	✓	£135.00
50mtr Roll c/w 125 clips	For 125mm gutters	GRID140	✓	£145.00
	For 150mm gutters	GRID155	✓	£160.00





Description	Size	Code	✓	£
2M ROUND DOWNPIPE – With ears				
	63mm	AL25REDP2	✓	£93.17
	76mm	AL3REDP2	✓	£108.57
	100mm	AL4REDP2	✓	£185.24

3M ROUND DOWNPIPE – With ears				
	63mm	AL25REDP3	✓	£122.62
	76mm	AL3REDP3	✓	£142.90
	100mm	AL4REDP3	✓	£243.15

ROUND EARED PIPE SOCKET				
	63mm	AL25ES	✓	£20.70
	76mm	AL3ES	✓	£24.29
	100mm	AL4ES	✓	£49.04

ROUND UNEARED PIPE SOCKET				
	63mm	AL25ESNE	✓	£20.70
	76mm	AL3ESNE	✓	£24.29
	100mm	AL4ESNE	✓	£49.04

STANDARD "STAND OFF" DOWNPIPE CLIPS				
	63mm	AL25STPC	✓	£11.82
	76mm	AL3STPC	✓	£13.66
	100mm	AL4STPC	✓	£15.48

EARED PIPE SHOE				
	63mm	AL25SH	✓	£27.20
	76mm	AL3SH	✓	£37.44
	100mm	AL4SH	✓	£45.06

EARED ANTI-SPLASH SHOE				
	63mm	AL25ASSH	✓	£139.92
	76mm	AL3ASSH	✓	£148.55
	100mm	AL4ASSH	✓	£41.72

Description	Size	Code	✓	£
112.5° PIPE OFFSET – 75mm				
	63mm	AL25OS75	✓	£47.34
	76mm	AL3OS75	✓	£59.19
	100mm	AL4OS75	✓	£67.07

112.5° PIPE OFFSET – 150mm				
	63mm	AL25OS150	✓	£59.06
	76mm	AL3OS150	✓	£66.22
	100mm	AL4OS150	✓	£75.93

112.5° PIPE OFFSET – 225mm				
	63mm	AL25OS225	✓	£67.02
	76mm	AL3OS225	✓	£74.04
	100mm	AL4OS255	✓	£85.70

112.5° PIPE OFFSET – 305mm				
	100mm	AL4OS305	✓	£95.11

112.5° TWO PART PIPE OFFSET – up to 457mm				
	63mm	AL25TP400	✓	£62.20
	76mm	AL3TP400	✓	£70.75
	100mm	AL3TP400	✓	£70.75

112.5° TWO PART PIPE OFFSET – up to 685mm				
	63mm	AL25TP700	✓	£70.21
	76mm	AL3TP700	✓	£79.78
	100mm	AL4TP700	✓	£127.74

ROUND 90° DOWNPIPE BEND				
	63mm	AL25B90	✓	£29.04
	76mm	AL3B90	✓	£36.76
	100mm	AL4B90	✓	£51.13

✓ = NEXT DAY DELIVERY - order up to noon Mon - Fri for next working day delivery



Description	Size	Code	✓	£
-------------	------	------	---	---

ROUND 112° DOWNPIPE BEND				
	63mm	AL25B112	✓	£29.04
	76mm	AL3B112	✓	£36.76
	100mm	AL4B112	✓	£51.13

112° ROUND PIPE BRANCH				
	63mm	AL25J112	✓	£37.93
	76mm	AL3J112	✓	£45.61
	100mm	AL4J112	✓	£61.10

FLAT BACK HOPPER HEAD				
	63mm	AL25HO1	✓	£46.88
	76mm	AL3HO1	✓	£49.05
	100mm	AL4HO1	✓	£65.90
<i>Size: (mm) 200w x 190h x 170d</i>				

RECTANGULAR HOPPER HEAD				
	63mm	AL25HO2	✓	£62.04
	76mm	AL3HO2	✓	£64.85
	100mm	AL4HO2	✓	£99.63
<i>Size: (mm) 250w x 180h x 180d</i>				

ORNAMENTAL HOPPER HEAD (NO MOTIF)				
	63mm	AL25HO6	✓	£224.74
	76mm	AL3HO6	✓	£224.74
<i>Size: (mm) 400w x 200h x 200d</i>				

LARGE RECTANGULAR HOPPER HEAD				
	63mm	AL25HO7	✓	£164.77
	76mm	AL3HO7	✓	£164.77
	100mm	AL4HO7	✓	£164.77
<i>Size: (mm) 300w x 194h x 194d</i>				

VICTRIX HOPPER HEAD				
	76mm	AL3HO8	✓	£471.75
	100mm	AL4HO8	✓	£471.75
<i>Size: (mm) 300w x 410h x 225d</i>				

Ornamental Hoppers in these 7 standard RAL colours in 10 days

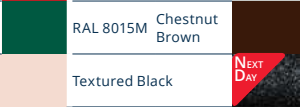
RAL 3009M Oxide Red	RAL 7016M Anthracite Grey	
RAL 3020M Traffic Red	RAL 7035M Light Grey	
RAL 6005M Moss Green	RAL 8015M Chestnut Brown	
	Textured Black	

ORNAMENTAL HOPPER HEAD (WITH MOTIF)				
	63mm	AL25HO3	✓	£224.74
	76mm	AL3HO3	✓	£224.74
	100mm	AL4HO3	✓	£224.74
<i>Size: (mm) 385w x 180h x 190d</i>				
				
Tudor Rose Motif - in 10 days	Lion Head Motif - in 10 days			

We can also add numbers (i.e. date of original build) to hoppers. If you don't see what you want here, please get in touch: 0800 644 44 26 or sales@rainclear.co.uk

FLUTED FLAT BACK HOPPER HEAD				
	63mm	AL25HO4	✓	£225.17
	76mm	AL3HO4	✓	£225.17
	100mm	AL4HO4	✓	£225.17
<i>Size: (mm) 250w x 215h x 177d</i>				
<i>Size: (mm) 300w x 260h x 212d</i>				

FLUTED CORNER HOPPER HEAD				
	63mm	AL25HO5	✓	£225.17
	76mm	AL3HO5	✓	£225.17
	100mm	AL4HO5	✓	£225.17
<i>Size: (mm) 177w x 215h x 177d</i>				
<i>Size: (mm) 212w x 260h x 212d</i>				

✓ = NEXT DAY DELIVERY – order up to noon Mon – Fri for next working day delivery



Description	Size	Code	£
1M SQUARE DOWNPIPE – with Eared Socket			
	75 x 75mm	AL33SQEDP1	£127.09
	100 x 75mm	AL43SQEDP1	£146.67
2M SQUARE DOWNPIPE – with Eared Socket			
	75 x 75mm	AL33SQEDP2	£205.53
	100 x 75mm	AL43SQEDP2	£240.15
3M SQUARE DOWNPIPE – with Eared Socket			
	75 x 75mm	AL33SQEDP3	£273.53
	100 x 75mm	AL43SQEDP3	£321.16
1M SQUARE DOWNPIPE – with non-eared socket			
	75 x 75mm	AL33SQNEP1	£273.53
	100 x 75mm	AL43SQNEP1	£146.65
2M SQUARE DOWNPIPE – with non-eared socket			
	75 x 75mm	AL33SQNEP2	£205.53
	100 x 75mm	AL43SQNEP2	£240.15
3M SQUARE DOWNPIPE – with non-eared socket			
	75 x 75mm	AL33SQNEP3	£273.50
	100 x 75mm	AL43SQNEP3	£321.16
STAND-OFF (200MM) DOWNPIPE CLIP			
	75 x 75mm	AL33SQDPC290	£28.85
	100 x 75mm	AL43SQDPC290	£29.90
PIPE SOCKET - with non-eared socket			
	75 x 75mm	AL33SQES	£41.51
	100 x 75mm	AL43SQES	£45.83

Description	Size	Code	£
112.5° PIPE OFFSET – 75mm			
	75 x 75mm	AL33SQOS3	£119.05
	100 x 75mm	AL43SQOS3	£135.64
112.5° TWO PART PIPE OFFSET – 305, 533, 762mm			
	75 x 75mm	AL33SQTP12	£155.88
	100 x 75mm	AL43SQTP12	£175.52
	75 x 75mm	AL33SQTP21	£168.48
	100 x 75mm	AL43SQTP21	£190.55
	75 x 75mm	AL33SQTP30	£179.84
	100 x 75mm	AL43SQTP30	£205.40
DOWNPIPE BEND - 90°, 112° & 135° (Direction of bend: Front/Back, Left/Right - tbc)			
	75 x 75mm	AL33SQB90	£93.01
	100 x 75mm	AL43SQB90	£105.43
	75 x 75mm	AL33SQB112	£93.01
	100 x 75mm	AL43SQB112	£105.43
	75 x 75mm	AL33SQB135	£93.01
	100 x 75mm	AL43SQB135	£105.43
DOWNPIPE BRANCH - 90°, 112° & 135° (Left or Right - tbc)			
	75 x 75mm	AL33SQJ90	£217.00
	100 x 75mm	AL43SQJ90	£234.39
	75 x 75mm	AL33SQJ112	£217.00
	100 x 75mm	AL43SQJ112	£234.39
	75 x 75mm	AL33SQJ135	£217.00
	100 x 75mm	AL43SQJ135	£234.39

SQUARE & RECTANGULAR DOWNPIPES are available in the below textured colour options in **7-15 working days**; See page 27 for standard RAL Matt colours available in 7-10 working days; and can also be supplied in plain mill finish for on-site painting. Get in touch if this is your preference. Contact us on 0800 644 44 26 to request a free colour swatch.

Colour Options: Textured

Textured Black	
RAL 7012M Basalt Grey	
RAL 7015M Slate Grey	
RAL 7016M Anthracite Grey	
RAL 7037M Dusty Grey	
RAL 9016M White	

WHAT DO WE MEAN BY TEXTURED?

See our blog at:

rainclear.info/TextBlack



SOCKETED SQUARE & RECTANGULAR DOWNPIPES



Description	Size	Code	£
ACCESS PIPE			
	75 x 75mm	AL33SQAP	£136.20
	100 x 75mm	AL43SQAP	£145.62
SHOE - with & without Ears			
	75 x 75mm	AL33SQSH	£86.15
	100 x 75mm	AL43SQSH	£93.14
	75 x 75mm	AL33SQSHNE	£86.15
	100 x 75mm	AL43SQSHNE	£93.71

Description	Size	Code	£
RECTANGULAR HOPPER			
	75 x 75mm	AL33HO2	£97.32
	100 x 75mm	AL43HO2	£97.32
ORNAMENTAL HOPPER			
	75 x 75mm	AL33HO3	£472.83
	100 x 75mm	AL43HO3	£472.83



90° Internal Angle



90° External Angle



135° Internal Angle



135° External Angle



Fascia Bracket



Drive in Rise & Fall Bracket



Rafter Bracket Side Fix



Rafter Bracket Top Fix



Running Outlet



Gutter Union



Half Round Gutter



Stop End



Fluted Flat Back Hopper



Ornamental Hopper



Rectangular Hopper



Socket Outlet



Spigot Outlet



Fixed Offsets: 75mm & 150mm



Two-Part Offsets:



Up to 457mm

Up to 685mm

Downpipe Clip



Socket Without Ears



Downpipe With Ears



Socket With Ears



90° Bend



112° Bend



112° Branch



Shoe With Ears





CAST ALUMINIUM | HEAVY-WALL DOWNPIPE

NEW - Heavier / thicker-wall pipe: with a 3.2mm thick wall for the high traffic end of each downpipe drop.

Slots right into the regular weight round downpipe, but offers greater durability - takes the hard knocks without showing it. Ideal for Schools and Equestrian areas.

Description	Size	Code	✓	£
NEW HEAVY WALL ALUMINIUM DOWNPIPE WITH CAST EARED SOCKET				
	76mm (3") x 2m	AL3HWREDP2	✓	£149.31

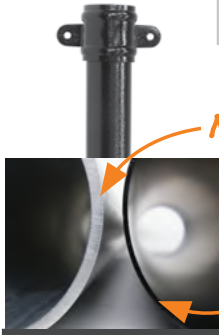

NEW thicker 3.2mm wall

usual 1.2mm downpipe wall thickness



Available in Textured Black in 10 days. Other textured colours available on request (see pg.41 - surcharges and longer lead times may apply). Get in touch on 0800 644 44 26 to discuss your requirements.

✓ = NEXT DAY DELIVERY – order up to noon
Mon – Fri for next working day delivery



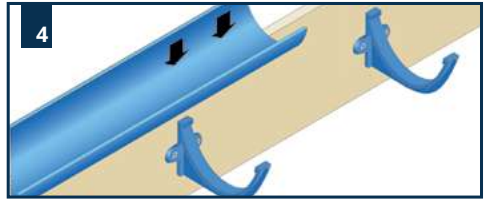
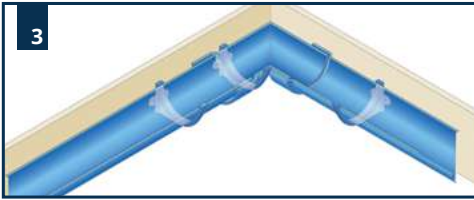
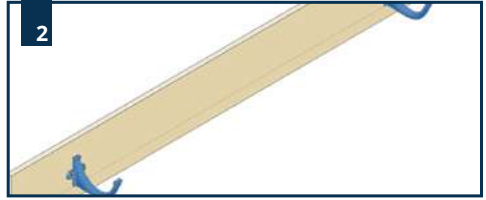
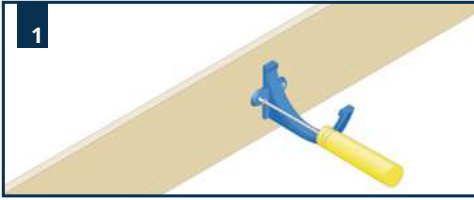

OPTION A | SEALANT METHOD

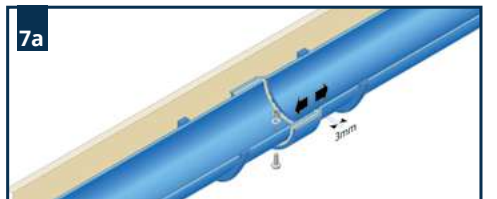

OPTION B | METSEAL METHOD



It is important to select the correct angle and stop end type to fit the required application.
 NOTE: The Cast Aluminium Victorian Ogee Gutter System is a left hand socketed system (see overleaf →).



CAST ALUMINIUM GUTTERING |

HALF ROUND

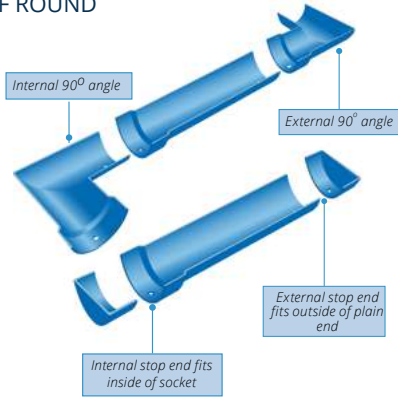

VICTORIAN OGEE

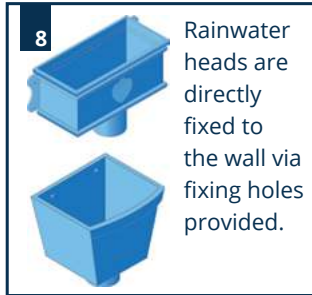
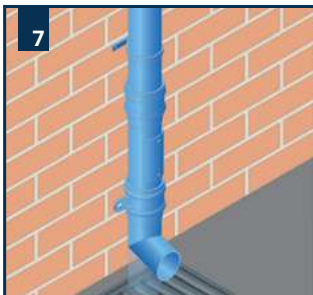
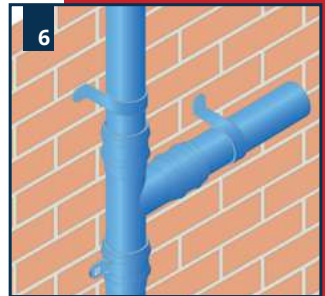
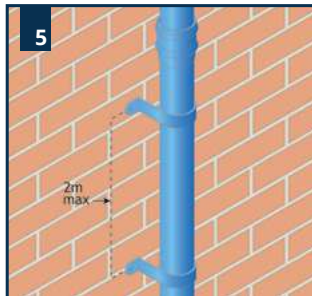
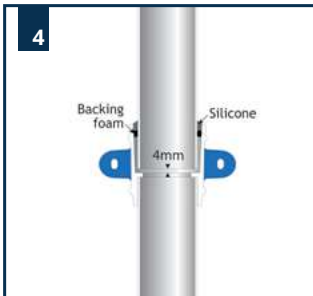
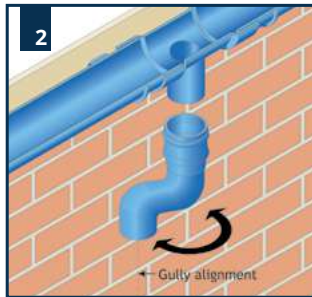
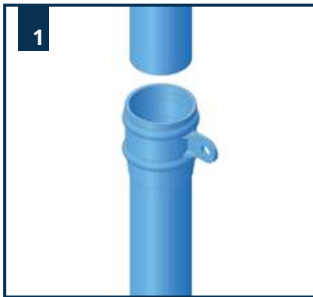
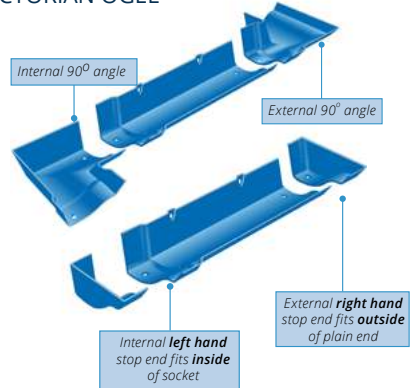

You can download full installation guide PDFs from our website at: rainclear.info/ca-inst



ALUMINIUM & GLASS VERANDAS



Our new range of UK Manufactured Veranda and Garden Rooms are perfect for completing your contemporary or heritage outdoor spaces, available as standard with:

- 110 x 110mm aluminium frame with integral drainage in RAL 7016 Anthracite Grey and RAL9016 White. (other frame colours are available - complete the contact form and we'll be in touch to discuss your requirements)
- Choice of Laminated Glass roof panels or Polycarbonate in Opal, Clear or Bronze.

A Standard range of sizes are available online:

- From 3 x 3m to 6 x 3m. (other sizes are available - complete the contact form and we'll be in touch to discuss your requirements)
- The unique Rainclear design means there is no requirement for a centre post on the Verandas up to 5m wide.
- Typical lead time of 2 to 3 weeks and delivery direct from factory to your point of installation.

The Rainclear Systems range is designed to be easy to install by competent DIY enthusiasts, saving the additional cost of a contractor.

N.B. Self - install - ideal for new builds, self-build, as well as renovations and 'do-ups'!

SnapIT ALUMINIUM

Rainclear's SnapIT aluminium rainwater system joins together using concealed internal joints which give a smooth, clean appearance and is ideal for contemporary building design. The range consists of the three gutter profiles most commonly installed in the British Isles, half round, vintage moulded ogee and box profile. The gutter system is complimented by a swaged round pipe system in 63mm or 76mm diameter or swaged square pipes in 63 x 63mm or 76mm x or 76mm.

The SnapIT aluminium rainwater system is available from stock in a smooth matt black powder coated finish.

All standard RAL colours below are available on a 7-10 working day lead-time.

Colour Options Matt

RAL 1013M	Pearl White		RAL 7024M	Graphite Grey	
RAL 1035MET	Pearl Beige Metallic		RAL 7032M	Pebble Grey	
RAL 3012M	Beige Red		RAL 7035M	Light Grey	
RAL 6005M	Moss Green		RAL 7037M	Dusty Grey	
RAL 7002M	Olive Grey		RAL 7038M	Agate Grey	
RAL 7004M	Signal Grey		RAL 7040M	Window Grey	
RAL 7005M	Mouse Grey		RAL 8014M	Sepia Brown	
RAL 7006M	Beige Grey		RAL 8017M	Chocolate Brown	
RAL 7012M	Basalt Grey		RAL 8019M	Grey Brown	
RAL 7015M	Slate Grey		RAL 9005M	Jet Black	
RAL 7016M	Anthracite Grey		RAL 9006M	Metallic Silver	
RAL7021M	Black Grey		RAL 9010M	Pure White	
RAL 7022M	Umbra Grey		RAL 9016M	White	
			RAL 9017M	Black	NEXT DAY

Colours are reproduced for general guidance only.

For exact colour and finish references please contact us for colour swatch samples

SNAPIT HALF ROUND Page 49

NEXT DAY



See colours on page 48

SNAPIT MOULDED Page 52

NEXT DAY



See additional textured colours on page 48

BOX GUTTER Pages 54-55

NEXT DAY



SWAGED DOWNPIPE Pages 56-57

NEXT DAY



SWAGED SQUARE DOWNPIPE Page 58

NEXT DAY



See colours on page 48

NEXT DAY DELIVERY!



ON ALL STOCKED PRODUCTS

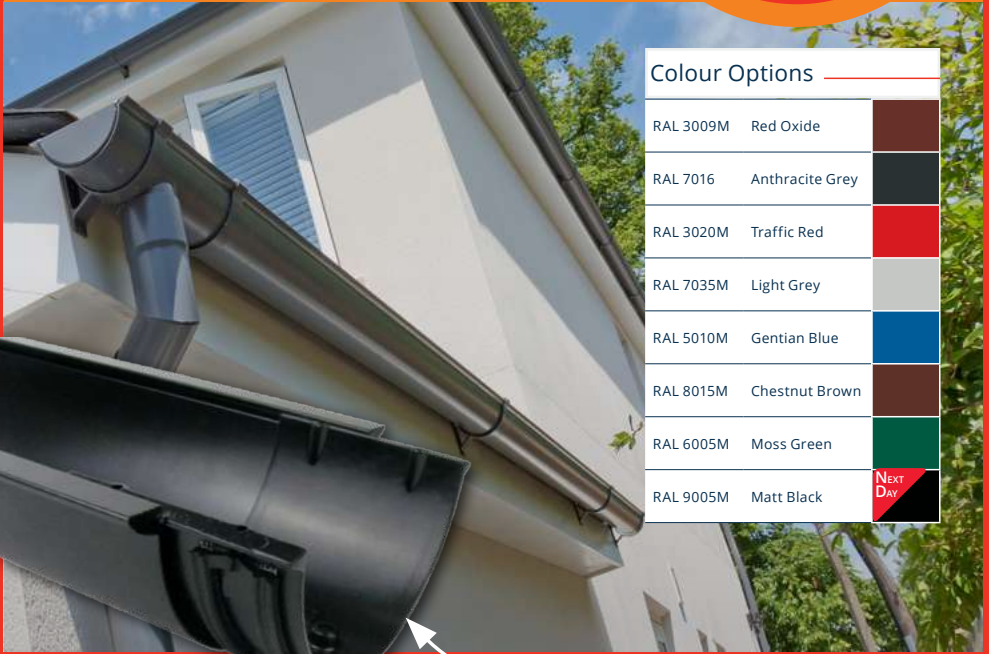

Order by noon for next working day delivery



Colour Options

RAL 3009M	Red Oxide	
RAL 7016	Anthracite Grey	
RAL 3020M	Traffic Red	
RAL 7035M	Light Grey	
RAL 5010M	Gentian Blue	
RAL 8015M	Chestnut Brown	
RAL 6005M	Moss Green	
RAL 9005M	Matt Black	

Benefits of SnapIT EXPRESS

- NEW Snap together and inject silicone fixing method
- 3m long gutters and pipes
- Choice of **Matt Black** for Next Day delivery and 7 Standard Matt RAL colours in 10 Days
- Low maintenance
- Easy to install

*Innovative new swifter
installation method =
less mess and waste*





Description	Size	Code	£
SnapIT HALF ROUND GUTTER 3m			
	115mm	AL45SNHRG	£98.36
	125mm	AL5SNHRG	£109.75

Supplied with 1no FOC union

SnapIT HALF ROUND GUTTER UNION			
	115mm	AL45SNHRU	£11.38
	125mm	AL5SNHRU	£12.67

Unions are only required where gutters are cut on-site

SnapIT FASCIA BRACKET			
	115mm	AL45SNHRFB	£8.97
	125mm	AL5SNHRFB	£9.04

SnapIT RISE AND FALL BRACKET			
	115mm	AL45SNRFB	£20.52
	125mm	AL5SNRFB	£20.62

SnapIT SIDE FIX BRACKET			
	115mm	AL45SNSFB	£24.73
	125mm	AL5SNSFB	£24.80

All supplied with FOC recommended SnapIT silicone

Description	Size	Code	£
SnapIT HALF ROUND STOP END			
	115mm	AL45SNHRE1	£13.45
	125mm	AL5SNHRE1	£14.48

SnapIT HALF ROUND OUTLET 63mm			
	115mm	AL45SNHRRO1	£32.45
	125mm	AL5SNHRRO1	£35.99

Supplied with 1no FOC union

SnapIT HALF ROUND OUTLET 76mm			
	115mm	AL45SNHRRO2	£33.19
	125mm	AL5SNHRRO2	£36.08

Supplied with 1no FOC union

SnapIT HALF ROUND 90° ANGLE			
	115mm	AL45SNHR90A	£41.01
	125mm	AL5SNHR90A	£46.64

Supplied with 1no FOC union

SnapIT HALF ROUND 135° ANGLE			
	115mm	AL45SNHR135A	£38.66
	125mm	AL5SNHR135A	£43.38

Supplied with 1no FOC union



GUTTER FIXING

We advise that you ensure the fixing background (e.g fascia board) is securely fixed, level and able to support the weight of the gutter at full capacity and that the roof overhang is correct – see gutter position.

Buildings without fascias may need a different type of bracketry. We offer a range of brackets to suit most applications. We offer side and top fix rafter arms as well as rise and fall brackets. The latter do not meet current BS/EN load requirements so advice should be sort on the parameter of their use.

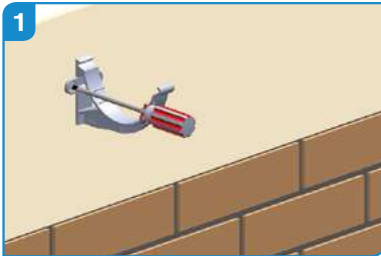

Start by deciding whether to fit the gutter level or with a fall to 1:600. Fit a bracket at each end of a run. Position brackets correctly for an angle or stopend.

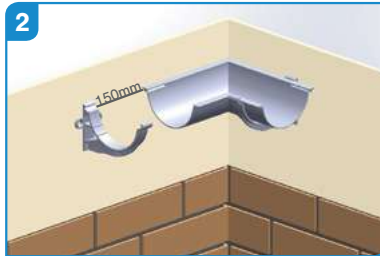
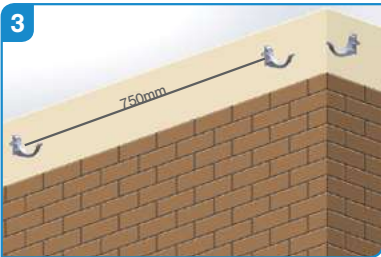

Image 2 shows the bracket positioning for the angle and bracket to take the gutter length.



We recommend fixing brackets every 750mm and using an additional bracket for each outlet or angle. Ideally using a string line or laser level between the two brackets, set out intermediate brackets at maximum centres of 750mm.



With the use of a plumb or laser line, position outlets over gullies and support with at least one bracket. Also include a bracket per angle (internal or external).

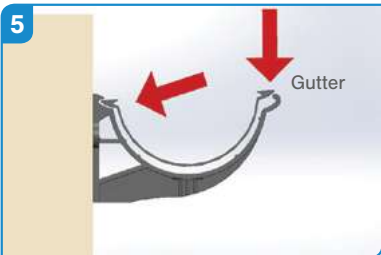

When fitting outlets and angles tuck the rear face of the gutter underneath the roof finish. Locate the gutter into the fascia bracket and then clip the front edge down into position.

After fitting outlets and angles, proceed with fitting the gutter lengths using the same method.

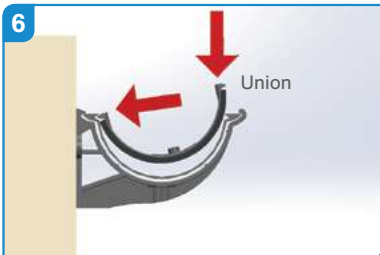

Ensure that all fixing surfaces are clean and dry. Placing the union into the groove in the rear face of the gutter and clip down into place on the front edge.

(For help with the 'knack' here watch our video: bit.ly/RC_videos)



Trim 4-5 mm off top of nozzle so it fits snugly into the large holes in the base of the union, inject the **special* SnapIT Express** low modulus sealant supplied into one of the large holes in the bottom of the union until the sealant appears at both of the smaller holes at the rim of the union. Repeat the action on the other large hole. (***Sealant only available from us**).

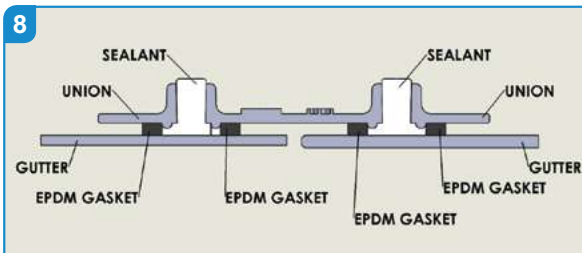

Ensure you apply the sealant gently to ensure the void is fully filled.

Clean off any excess sealant and then use the same process for every joint until the work is completed.

All lengths are supplied in a protective polythene wrapping with components similarly wrapped and stored in cardboard boxes. If painted product is to be stored outside, cover with tarpaulin to protect against rainfall and direct sunlight as if water gets trapped inside the protective covering and is exposed to warm sunlight then it may leave permanent watermarks on the paint finish. Mill finish items should be stored under cover to avoid uneven oxidation prior to being fitted.

Any use of sealant must not be carried out in wet weather or in temperatures below 5°C or above 50°C. All Joint surfaces must be perfectly clean and dry. Only a low modulus sealant must be used to prevent early failure. Ensure that the gutter joint sockets/spigots are correctly aligned with each other to ensure free thermal movement (3-4mm) within the gutter joint.

Any cut lengths should be de-burred and touched up with touch-up paint supplied prior to installation. For more information or further assistance, please contact us.



Description	Size	Code	✓	£
SnapIT MOULDED OGEE GUTTER 3m				
	125 x 100	AL54OGG	✓	£137.67

SnapIT MOULDED OGEE UNION				
	125 x 100	AL54OGU	✓	£7.64
<i>Unions are only required where gutters are cut on-site</i>				

SnapIT MOULDED FASCIA BRACKET				
	125 x 100	AL54OGFB	✓	£10.19

SnapIT MOULDED OGEE RISE & FALL BRACKET				
	125 x 100	AL54OGRFB	✓	£20.80

SnapIT MOULDED OGEE SIDE FIX RAFTER BRACKET				
	125 x 100	AL54OGSFB	✓	£25.25

Next Day Delivery Colours:

Textured Black		
RAL 9017M Matt Black		

See other Standard Matt colours for delivery in 7-10days on page 47 & 48

Other Standard Textured Colours:

RAL 7012M	Basalt Grey	
RAL 7015M	Slate Grey	
RAL 7016M	Anthracite Grey	
RAL 7037M	Dusty Grey	
RAL 9016M	White	

WHAT DO WE MEAN BY TEXTURED?

See our blog at:

rainclear.info/TextBlack



Description	Size	Code	✓	£
SnapIT MOULDED OGEE LEFT HAND STOPEND				
	125 x 100	AL54OGE1	✓	£15.51

SnapIT MOULDED OGEE RIGHT HAND STOP END				
	125 x 100	AL54OGE2	✓	£15.51

SnapIT MOULDED OGEE 76mm OUTLET				
	125 x 100	AL54OGRO2	✓	£33.55
<i>Supplied with 1no FOC union</i>				

SnapIT MOULDED OGEE 90° EXTERNAL ANGLE				
	125 x 100	AL54OG90E	✓	£40.12
<i>Supplied with 1no FOC union</i>				

SnapIT MOULDED OGEE 90° INTERNAL ANGLE				
	125 x 100	AL54OG90I	✓	£40.12
<i>Supplied with 1no FOC union</i>				

SnapIT MOULDED OGEE 135° EXTERNAL ANGLE				
	125 x 100	AL54OG135E	✓	£37.54
<i>Supplied with 1no FOC union</i>				

SnapIT MOULDED OGEE 135° INTERNAL ANGLE				
	125 x 100	AL54OG135I	✓	£37.54
<i>Supplied with 1no FOC union</i>				



FLAT & PITCHED ROOF ROOFLIGHTS

Rainclear Systems now supplies modern and heritage style designs, for both flat and pitched roofs – each one expertly and sustainably constructed using a combination of robust steel, glass, and aluminium.

Online at www.rainclear.co.uk now you will find three different styles of rooflight in our premium range including the modern flat roof, modern pitched roof, and the heritage pitched roof.

With a choice of opening methods, handles, and blinds/shading solutions, you can customise each rooflight to suit the room its for – making a fantastic addition to bedrooms, kitchen or living areas.



NEXT DAY DELIVERY!

ON ALL STOCKED PRODUCTS

Order by noon for next working day delivery



Box Gutter

If you are looking for a box gutter for a contemporary or commercial building design the Pressed Aluminium Box Gutter range offers a long life, low maintenance alternative to uPVC, while also accommodating thermal expansion at every joint and being 100% recyclable.

Joints are wet sealed and bolted in a simple but time proven method.

The gutter system is complimented by the swaged round downpipe, in 63mm or 76mm diameter (pg.56), or swaged square downpipe in 75x75mm, 75x100mm or 100x100mm.

Benefits of Pressed Aluminium Box Gutter

- Robust, non-corrodible & lightweight - ideal where maximum capacity gutters are required
- 3m long gutters - bracketry concealed after fixing, supported by top straps
- Low maintenance - no requirement to repaint during lifetime
- Life expectancy of 40years in rural/suburban and 25 in marine/industrial areas
- Aluminium is 100% recyclable
- **Matt Black** is available from stock for **Next Day Delivery** and the other standard RAL colours (pg.48) are available on a 10 working day lead-time.



Description	Size	Code	£
BOX GUTTER - 3M			
	125 x 100	AL54BXG	£156.21

Supplied with top fixing straps

Description	Size	Code	£
BOX GUTTER UNION			
	125 x 100	AL54BXU	£12.24

Unions are only required where gutters are cut on-site

Description	Size	Code	£
LEFT HAND STOP END (150MM LONG)			
	125 x 100	AL54BXE2	£32.22

Supplied with top fixing straps

Description	Size	Code	£
RIGHT HAND STOP END (150MM LONG)			
	125 x 100	AL54BXE1	£32.22

Supplied with top fixing straps

Description	Size	Code	£
RUNNING OUTLET - 76MM & 100MM OUTLET			
	125 x 100 x 76	AL54BXRO2	£48.19

	125 x 100 x 100	AL54BXRO3	£50.20
--	--------------------	-----------	--------

Supplied with top fixing straps

Description	Size	Code	£
RUNNING OUTLET - 76X76MM OUTLET			
	125 x 100 x 76x76	AL54BXRO33	£49.50

Supplied with top fixing straps

Description	Size	Code	£
PATCH OUTLETS			
	63mm	25RTH	12.51
	76mm	3RTH	12.51
	76x76mm	33STH	12.51

Description	Size	Code	£
90° EXTERNAL GUTTER ANGLE			
	125 x 100	AL54BX90E	£70.13

Supplied with top fixing straps

Description	Size	Code	£
90° INTERNAL GUTTER ANGLE			
	125 x 100	AL54BX90I	£70.13

Supplied with top fixing straps

Description	Size	Code	£
135° EXTERNAL GUTTER ANGLE			
	125 x 100	AL54BX135E	£65.37

Supplied with top fixing straps

Description	Size	Code	£
135° INTERNAL GUTTER ANGLE			
	125 x 100	AL54BX135I	£65.37

Supplied with top fixing straps

Description	Size	Code	poa
BOX GUTTER - TOP FIXING STRAP			
	125 x 100	AL54BXTS	poa

Only required for spares/replacements

Matt Black is available from stock for Next Day Delivery and the other standard RAL colours (pg.48) are available on a 10 working day lead-time.

Other colours are available but surcharges and lead-times may vary.

Call us on 0800 644 44 26 for more information or if you don't see what you require in here.



Description	Size	Code	✓	£
SWAGED DOWNPIPE 2m				
	63mm	AL25SWREDP2	✓	£56.80
	76mm	AL3SWREDP2	✓	£62.60

Description	Size	Code	✓	£
SWAGED DOWNPIPE 3m				
	63mm	AL25SWREDP3	✓	£89.34
	76mm	AL3SWREDP3	✓	£98.07

Description	Size	Code	✓	£
SWAGED DOWNPIPE CLIP				
	63mm	AL25SWSTPC	✓	£10.68
	76mm	AL3SWSTPC	✓	£10.81

Description	Size	Code	✓	£
SWAGED DOWNPIPE CONNECTOR				
	63mm	AL25SWSOC	✓	£20.98
	76mm	AL3SWSOC	✓	£23.27

Description	Size	Code	✓	£
SWAGED DOWNPIPE SHOE				
	63mm	AL25SWSH	✓	£22.28
	76mm	AL3SWSH	✓	£23.05

Description	Size	Code	✓	£
SWAGED OFFSET - 75mm				
	63mm	AL25SWOS75	✓	£46.41
	76mm	AL3SWOS75	✓	50.12

Description	Size	Code	✓	£
SWAGED TWO PART OFFSET - Up to 400mm				
	63mm	AL25SWTP400	✓	£53.72
	76mm	AL3SWTP400	✓	£59.70

Description	Size	Code	✓	£
SWAGED TWO PART OFFSET- Up to 750mm				
	63mm	AL25SWTP750	✓	£59.46
	76mm	AL3SWTP750	✓	£67.65

Description	Size	Code	✓	£
SWAGED 90° BEND				
	63mm	AL25SWB90	✓	£24.75
	76mm	AL3SWB90	✓	£25.91

Description	Size	Code	✓	£
SWAGED 112° BEND				
	63mm	AL25SWB112	✓	£24.75
	76mm	AL3SWB112	✓	£25.91

Description	Size	Code	✓	£
SWAGED 135° BEND				
	63mm	AL25SWB135	✓	£24.75
	76mm	AL3SWB135	✓	£25.91

Description	Size	Code	✓	£
SWAGED 112° BRANCH				
	63mm	AL25SWBR112	✓	£54.46
	76mm	AL3SWBR112	✓	£56.48

✓ = NEXT DAY DELIVERY - order up to noon Mon - Fri for next working day delivery



SnapIT ALUMINIUM |

Description	Size	Code	✓	£
-------------	------	------	---	---

SWAGED NEPTUNE HOPPER



63mm	AL25SWHO1	✓	£134.70
76mm	AL3SWHO1	✓	£134.70

Size (mm) : 280w x 280h x 150d

SWAGED JUNO HOPPER



63mm	AL25SWHO2	✓	£92.26
76mm	AL3SWHO2	✓	£92.26

Size (mm) : 228w x 190h x 190d

SWAGED SATURN HOPPER



63mm	AL25SWHO3	✓	£106.17
76mm	AL3SWHO3	✓	£106.17

Size (mm) : 280w x 200h x 215d

The swaged round aluminium pipes are available from stock for **Next Day Delivery** in **Matt Black** powder coated finish in **63mm & 76mm** diameter pipe, and **RAL7016 Anthracite Grey** in the **76mm only**.

Next Day Delivery Colour Options:

RAL 9017M	Matt Black	63mm & 76mm	✓
RAL 7016M	Anthracite Grey	76mm only	✓

All standard RAL colours listed on pg.47 are available in **7-10 working days**.

Other colours are available but surcharges and lead-times may vary.

Call us on **0800 644 44 26** for more information or if you don't see what you require here.



ROUND PIPES



**NEXT DAY
DELIVERY!**
ON ALL STOCKED PRODUCTS



Order by noon for next working day delivery





SQUARE PIPES

The SnapIT gutter system is complimented by swaged round (pg.56) or swaged square pipes.

The swaged square aluminium pipes are available from stock for **Next Day Delivery** in a smooth **Matt Black** powder coated finish in 63x63mm or 76x76mm.

All standard RAL colours listed on pg.48 are available in **10 working days**.

Other colours are available but surcharges and lead-times may vary.

Description	Size	Code	✓	£
HOPPERS WITH SQUARE OUTLETS				
	76 x 76mm	AL33SWHO1	✓	£134.70
	76 x 76mm	AL33SWHO2	✓	£92.26
	76 x 76mm	AL33SWHO3	✓	£106.17









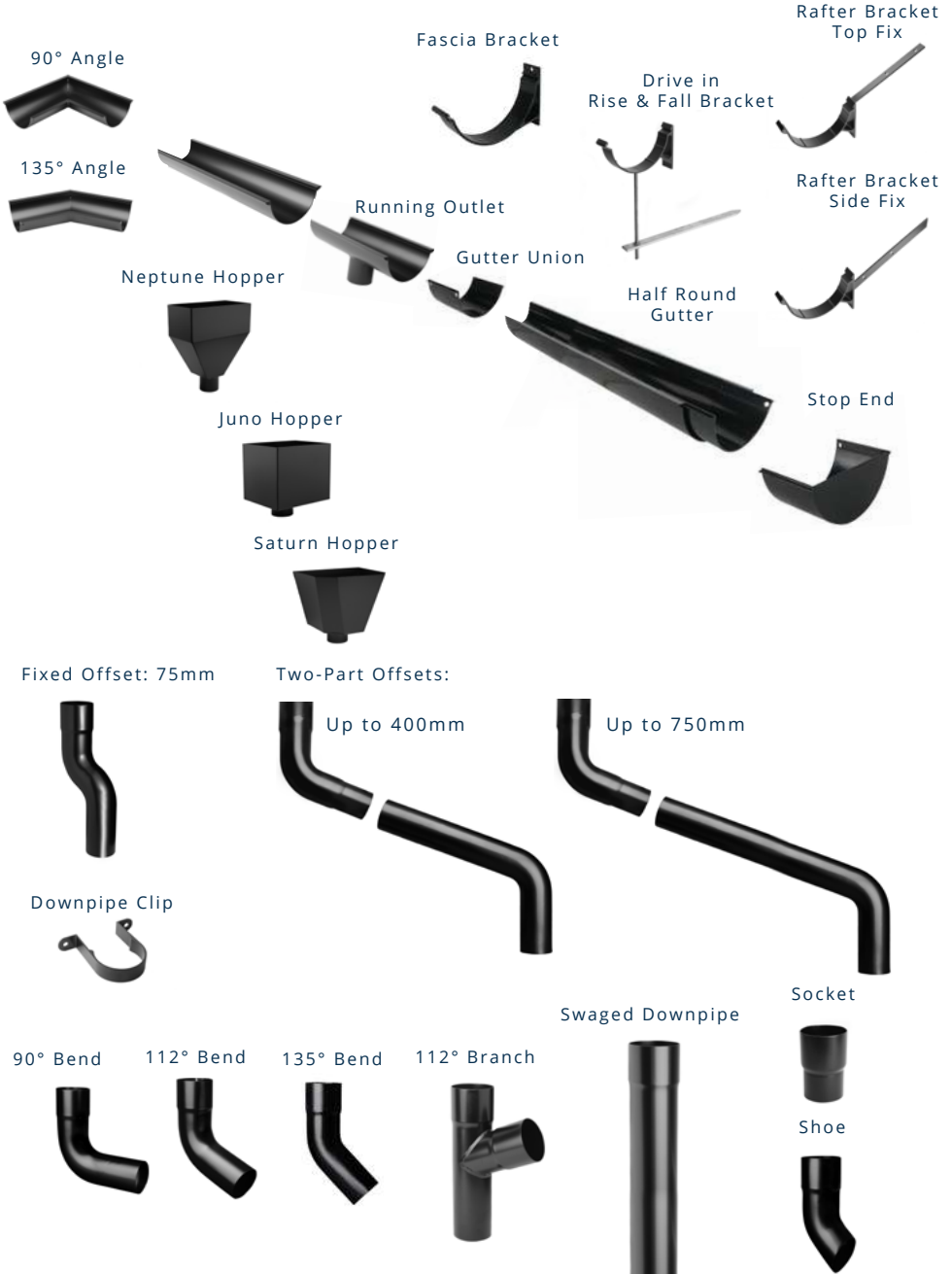



Description	Size	CODE	✓	£	Description	Size	Code	✓	£
SWAGED SQUARE DOWNPIPE					112.5° PIPE OFFSET – 75mm & 150mm				
	76 x 76mm	AL33SWREDP3	✓	£112.92		76 x 76mm	AL33SWOS75	✓	£61.17
	76 x 76mm	AL33SWREDP2	✓	£75.94		76 x 76mm	AL33SWOS150		£61.17
STANDARD FLUSH DOWNPIPE CLIP					112.5° TWO PART PIPE OFFSET – 400,750 & 1000mm				
	76 x 76mm	AL33SWFFPC	✓	£10.52		76 x 76mm	AL33SWTP400	✓	£67.31
STAND-OFF (30MM) DOWNPIPE CLIP						76 x 76mm	AL33SWTP750	✓	£77.10
	76 x 76mm	AL33SWSTPC	✓	£10.80		76 x 76mm	AL33SWTP1000		£81.13
STAND-OFF (200MM) DOWNPIPE CLIP					DOWNPIPE BEND - 90°, 112° & 135°				
	76 x 76mm	AL33SWSOPC		25.63		76 x 76mm	AL33SWB90	✓	£30.11
LOOSE CONNECTOR						76 x 76mm	AL33SWB112	✓	£30.11
	76 x 76mm	AL33SWSOC	✓	£19.75		76 x 76mm	AL33SWB135	✓	£30.11
DRAIN ADAPTER					DOWNPIPE BRANCH - 90°, 112° & 135°				
	76 x 76mm	AL33SWADP		£32.45		76 x 76mm	AL33SWBR112	✓	£39.75
ACCESS PIPE & PIPE PLATE									
	76 x 76mm	AL33SWAPP		£33.79					
	76 x 76mm	AL33SWAP		£10.57					
PIPE SHOE									
	76 x 76mm	AL33SWSH	✓	£25.81					

Call us on 0800 644 44 26 for more information or if you don't see what you require in here.

✓ = NEXT DAY DELIVERY – order up to noon Mon – Fri for next working day delivery





Description	Size	Code	✓	£
 Silicone Sealant	Black 310cc Dow Corning Silicone	791BLACK	✓	£9.98
 Black Touch Up Paint & Brush	125ml	ALTUPM	✓	£9.98
 Countersunk Screw	No 10 x 1.5"	COUNT15	✓	£0.12
 Roundhead Screw & Washer	No 12 x 2"	SCREW20	✓	£0.12
 Roundhead Screw & Washer	No 12 x 1.5"	SCREW15	✓	£0.12
	10m x 6mm	BFOAM	✓	£5.52
 Fast Drying Solvent Cleaner	500ml	SOLCLEN	✓	£10.02
 Downpipe Fixing Pack for Aluminium	20 x 40mm hex screws, washers, wall plugs & caps	DPS40	✓	£12.83
 Gutter Guard Brush	75mm	BRUSH75	✓	£15.97
	100mm	BRUSH100	✓	£16.79
	125mm	BRUSH125	✓	£19.43
 Gutter Grid Mesh 50mtr Roll c/w 125 clips	For 100mm & 115mm gutters	GRID115	✓	£135.00
	For 125mm gutters	GRID140	✓	£145.00
	For 150mm gutters	GRID155	✓	£160.00



ALUMINIUM WINDOW SURROUND PODS

This range of high quality made-to-order Deepline (with a 100mm projection from the building facade) or Slimline (50mm projection from the building facade). Aluminium Window Surrounds kits are available in 27 standard colours and 3 'face' depths (i.e. from the door frame outwards).

We will call you after you have placed your order to confirm which colour you require so be sure to include your phone number when you place your order.

If you don't find what you are looking for listed here, just give us a call on 0800 644 44 26 or email sales@rainclear.co.uk

The Surrounds will take 15 days from when we receive your approval of drawings (better safe than sorry!) to paint and deliver to your site or mainland UK address.

With the longevity you can expect from an Aluminium product AND 27 standard RAL colours to choose from, these Window Surrounds kits will provide a perfect finish to your building.



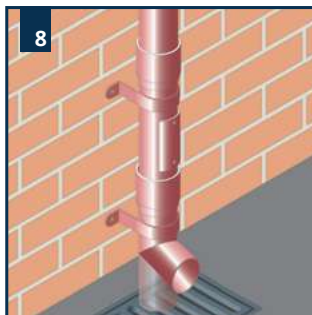
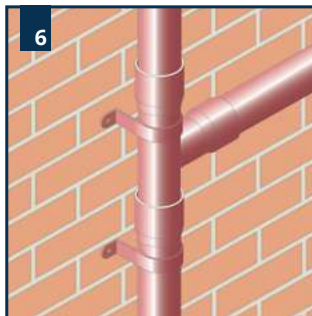
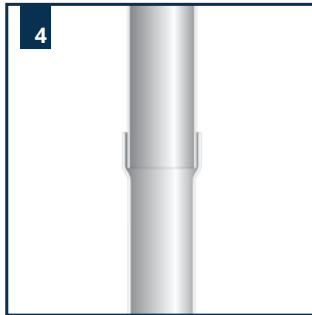
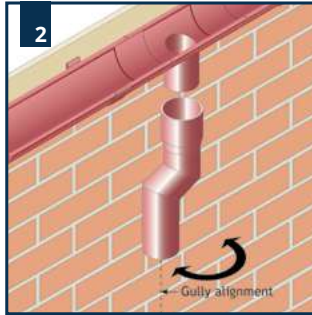
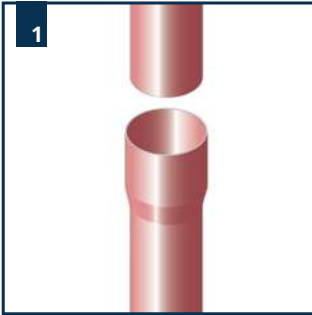

You can download full installation guide PDFs from our website at: rainclear.info/snp-inst

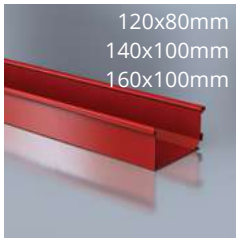

120x80mm
140x100mm
160x100mm

AQUALINE BOX

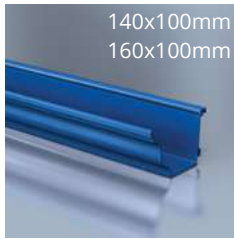

140x100mm
160x100mm

AQUALINE MOULDED

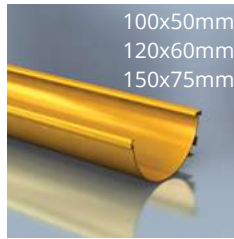

100x50mm
120x60mm
150x75mm

AQUALINE HALF ROUND

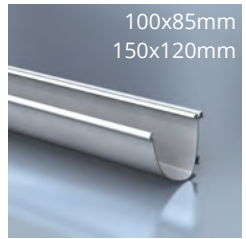

100x85mm
150x120mm

AQUALINE MODERN

Aqualine contemporary, extruded Gutters come with secret bracketry, all-weather 'dry' jointing for ease of installation and provision for full thermal movement at every joint. Robust and long-lasting (25-40 years depending on the environment and location)

Manufactured by Alumasc in a huge range of BBA approved powder coated finishes

- 27 Standard Matt RAL colours in 7-10 days leadtime
- For Plain Mill Finish (unpainted) **call us on 0800 644 44 26**

Choose from the 27 Standard RAL colours on pg.47, then place your order online and we will call you to confirm the colour required.

If you don't see what you're looking for listed online, please call 0800 644 44 26.

We only added the most popular ranges to the website so far.

PLEASE NOTE: These items are 'made-to-order' and as such are non-refundable

Read more on our blog 'Even More New Products – Flushjoint, Guardian & Aqualine' rainclear.info/news





FLUSHJOINT

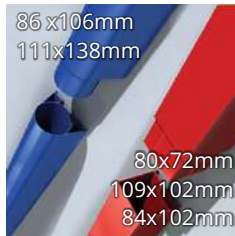

GUARDIAN

Flushjoint round & square aluminium downpipes are robust and long lasting. Concealed spigots give a smooth, clean appearance to these downpipes to complement any modern building design. Extruded Aluminium is lighter than cast iron but stronger than steel and will last for 25-40 years depending on the environment and location.

Guardian round & square aluminium downpipes are robust and long lasting. Designed for mounting flush with the building with concealed brackets & concealed joints for a high level of security. Extruded Aluminium is lighter than cast iron but stronger than steel and will last for 25-40 years depending on the environment and location.

Special colours are also possible but longer lead times and surcharges apply - **Call now on 0800 644 44 26 for a quotation.**

DELIVERY
IN 10-15 DAYS
27 STANDARD RAL COLOURS



ALUMINIUM FASCIA & SOFFIT

Benefits of Aluminium Fascia & Soffit

- 4 fascia profiles & 2 soffit profiles
- 3mtr lengths (including 1 no.Union)
- Internal/external corners
- Corner angle tbc
- Stop-ends
- Loose union clips.

In depth ranges from 75mm-600mm, depending on the profile you choose, and 27 Standard RAL colours as well as plain milled aluminium.

- UK manufactured from high quality BBA approved polyester coated aluminium. All processes controlled under ISO9001 & ISO14001 Quality and Environmental Management Systems
- If you can't find what you require on the website, or need some help placing your order, please call 0800 644 44 26
- PLEASE NOTE: Free delivery threshold of £1,250 apply to these made-to-order products.
- These items are 'made-to-order' and as such are non-refundable.

SKYLINE ALUMINIUM | FASCIA & SOFFIT



Skyline Aluminium Fascia & Soffit is the highly specified system from leading UK manufacturer Alumasc, widely recognised by architects, specifiers, contractors & developers for its engineered quality and striking design characteristics. The online range is delivered to order** in 10-15 days in a choice of 27 standard RAL colours. There are 4 different fascia profiles on the website, which will cover most applications, sizes range from 75mm up to circa 600mm depending on the profile you choose and you also have the option of 2 different soffit profiles.

See the manufacturer's standard RAL colours listed below. Contact us on 0800 644 44 26 to request a free colour swatch.

Colour Options

RAL 1013M	Pearl White		RAL 7024M	Graphite Grey	
RAL 1035MET	Pearl Beige Metallic		RAL 7032M	Pebble Grey	
RAL 3012M	Beige Red		RAL 7035M	Light Grey	
RAL 6005M	Moss Green		RAL 7037M	Dusty Grey	
RAL 7002M	Olive Grey		RAL 7038M	Agate Grey	
RAL 7004M	Signal Grey		RAL 7040M	Window Grey	
RAL 7005M	Mouse Grey		RAL 8014M	Sepia Brown	
RAL 7006M	Beige Grey		RAL 8017M	Chocolate Brown	
RAL 7012M	Basalt Grey		RAL 8019M	Grey Brown	
RAL 7015M	Slate Grey		RAL 9005M	Jet Black	
RAL 7016M	Anthracite Grey		RAL 9006M	Metallic Silver	
RAL7021M	Black Grey		RAL 9010M	Pure White	
RAL 7022M	Umbra Grey		RAL 9016M	White	
			RAL 9017M	Black	

Colours are reproduced for general guidance only. For exact colour and finish references please contact Rainclear for colour swatch samples and for further information.

**You will be asked to approve drawings before the products begin fabrication, so please allow time for this process in your plans/schedule, look out for the email with the drawings, check them *carefully*, and respond swiftly with your approval or any changes.

You can download the full Skyline price list from our website at: rainclear.info/pricelists



ALUMINIUM FASCIA



ALUMINIUM SOFFIT

DELIVERY IN 7-10 DAYS

27 STANDARD RAL COLOURS



We will contact you by return (Mon-Fri 8am-5pm) to confirm the following:

- The standard RAL colour you require – choose from 27 Standard RAL colours. (Other BS or RAL colours available to 'special order' but may mean an additional surcharge and a longer lead time)



You can download the installation guide
from our website at:
rainclear.info/cop_inst





SKYLINE ALUMINIUM | COPING

The Skyline aluminium coping system has a hidden strap fixing method (the fixing strap comes with an integral EPDM rubber seal) which avoids penetration of the capping, resulting in a weatherproof covering, whilst allowing ventilation over the top of the wall.

- Equally suited to retrofit and new build

- Fabricated fittings are mitred, welded beautifully for a smooth finish on the front face
- Typically fixing can be carried out from the roof so no external access is required.

See the manufacturer's standard RAL colours listed below.

Contact us on 0800 644 44 26 to request a free colour swatch.

Colour Options

RAL 1013M Pearl White		RAL 7024M Graphite Grey	
RAL 1035MET Pearl Beige Metallic		RAL 7032M Pebble Grey	
RAL 3012M Beige Red		RAL 7035M Light Grey	
RAL 6005M Moss Green		RAL 7037M Dusty Grey	
RAL 7002M Olive Grey		RAL 7038M Agate Grey	
RAL 7004M Signal Grey		RAL 7040M Window Grey	
RAL 7005M Mouse Grey		RAL 8014M Sepia Brown	
RAL 7006M Beige Grey		RAL 8017M Chocolate Brown	
RAL 7012M Basalt Grey		RAL 8019M Grey Brown	
RAL 7015M Slate Grey		RAL 9005M Jet Black	
RAL 7016M Anthracite Grey		RAL 9006M Metallic Silver	
RAL7021M Black Grey		RAL 9010M Pure White	
RAL 7022M Umbra Grey		RAL 9016M White	
		RAL 9017M Black	

Colours are reproduced for general guidance only. For exact colour and finish references please contact Rainclear for colour swatch samples and for further information.

Wall Size Ranges	Coping Code	Coping Width
91-120mm	SL12	182mm
121-180mm	SL18	242mm
181-240mm	SL24	302mm
241-300mm	SL30	362mm
301-360mm	SL36	422mm
361-420mm	SL42	482mm
421-480mm	SL48	542mm
481-540mm	SL54	602mm
541-600mm	SL60	662mm

Coping width is always greater than the wall width to ensure 31mm is maintained from external wall surface to external face of coping

See pg.71 for the specific product codes to add on the end of the coping 'size' codes listed above.

You can download the full Skyline price list from our website at: rainclear.info/pricelists



ALUMINIUM COPING

NEXT DAY DELIVERY

In 2 Sizes in Anthracite Grey



ALUMINIUM COPING

SKYLINE

ARCHITECTURAL ALUMINIUM

Benefits of Aluminium Coping

- Lightweight, durable and non-corrodible – Low maintenance
- Easy to handle and fix
- Life expectancy of 40 years in rural/suburban areas and up to 25 years in industrial/marine areas
- PLUS Aluminium is 100% recyclable at end of life.

Benefits of Skyline Aluminium Coping

- UK manufactured from high quality BBA approved polyester coated aluminium. All processes controlled under ISO9001 & ISO14001 Quality and Environmental Management Systems
- Hidden strap fixing method offers weather-proof covering that allows ventilation over the top of the wall. No fixings pass through the coping, there's no penetration of the capping, and clean lines are maintained on the surface.



Wall Size Range	Code	£
-----------------	------	---

3m LENGTH (includes 2no. fixing straps)



241-300mm	SL30_3M_7016	£190.56
301-360mm	SL36_3M_7016	£208.89

UPSTAND (includes 1no. fixing strap)



241-300mm	SL30_US_7016	£96.04
301-360mm	SL36_US_7016	£98.87

STOPEND (includes 1no. fixing strap)



241-300mm	SL30_CS_7016	£96.04
301-360mm	SL36_CS_7016	£98.87

The 2 sizes: SL30 & SL36

- SL30: The 362mm Aluminium Coping - Suitable for 241-300mm wide walls
- SL36: The 422mm Aluminium Coping - Suitable for 301-360mm wide walls

Both NOW stocked in RAL 7016 Anthracite Grey FOR NEXT DAY DELIVERY.

Wall Size Range	Code	£
-----------------	------	---

90 DEGREE ANGLE (includes 1.5no. fixing straps)



241-300mm	SL30_90_7016	£124.82
301-360mm	SL36_90_7016	£134.73

135 DEGREE ANGLE (includes 1.5no. fixing straps)



241-300mm	SL30_135_7016	£124.82
301-360mm	SL36_135_7016	£134.73

T-JUNCTION (includes 2no. fixing straps)



241-300mm	SL30_TJ_7016	£167.94
301-360mm	SL36_TJ_7016	£178.28

LOOSE FIXING STRAPS



241-300mm	SL30_FS_7016	£17.36
301-360mm	SL36_FS_7016	£18.83

NEXT DAY DELIVERY

In 2 Sizes in Anthracite Grey



ALUMINIUM SLOPING COPING

SKYLINE

ARCHITECTURAL ALUMINIUM

- Coping designed to produce a slope in towards the flat roof, where roof outlets can carry away rainwater, preventing it from potentially damaging the building's facade and leaving unsightly streaks.

Benefits of Aluminium Coping

- Made from lightweight, durable aluminium and coated in BBA approved powder coating colour. Aluminium is made from recycled material and when the coping reaches the end of its life the aluminium is also easily recycled again.
- Highly corrosion resistant. Expected lifespan of around 30 years with minimal maintenance
- Available in 27 RAL colours in 10-15 working days (production drawings need to be signed off by the customer prior to manufacture).

Benefits of Skyline Aluminium Coping

- UK manufactured from high quality BBA approved polyester coated aluminium. All processes controlled under ISO9001 & ISO14001 Quality and Environmental Management Systems
- Fully weatherproof covering to upstand parapets with a fixing method that does not penetrate the coping but does allow ventilation over the top of the wall. Manufactured in the UK
- Simple installation : Clip-on to fixing straps with EPDM rubber seals that have been screwed through marine board into the top of the parapet wall.



Wall Size	Code	£
-----------	------	---

3m LENGTH (includes 2no. fixing straps)



241-300mm	SC30_3M_7016	£232.50
301-360mm	SC36_3M_7016	£254.87

LH/RH UPSTAND (includes 1no. fixing strap)

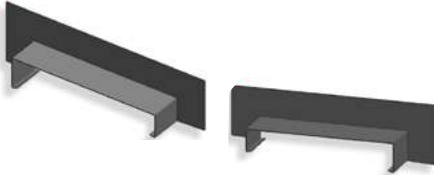

241-300mm	SC30_(LH/RH)US_7016	£117.17
301-360mm	SC36_(LH/RH)US_7016	£120.66

LH/RH STOPEND (includes 1no. fixing strap)



241-300mm	SC30_(LH/RH)CS_7016	£117.17
301-360mm	SC36_(LH/RH)CS_7016	£120.66

The 2 sizes: SC30 & SC36

- SC30: The 362mm Aluminium Coping - Suitable for 241-300mm wide walls
- SC36: The 422mm Aluminium Coping - Suitable for 301-360mm wide walls

Both NOW stocked in RAL 7016 Anthracite Grey FOR NEXT DAY DELIVERY.

Wall Size Range	Code	£
-----------------	------	---

90 DEGREE ANGLE EXTERNAL/INTERNAL (includes 1.5no. fixing straps)

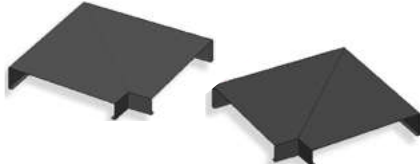

241-300mm	SC30_E/IA90_7016	£152.30
301-360mm	SC36_E/IA90_7016	£164.40

35 DEGREE ANGLE EXTERNAL/INTERNAL (includes 1.5no. fixing straps)

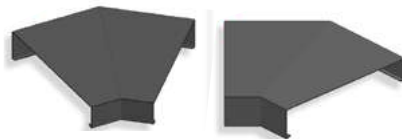

241-300mm	SC30_E/IA135_7016	£152.30
301-360mm	SC36_E/IA135_7016	£164.40

JUNCTION (LEFT-HAND, RIGHT-HAND OR FLAT) (includes 2no. fixing straps)



241-300mm	SC30_R/LHTJ_7016	£204.92
301-360mm	SC36_R/LHTJ_7016	£217.52

FIXING STRAPS (includes 1.5no. fixing straps)



241-300mm	SC30_FS_7016	£21.21
301-360mm	SC36_FS_7016	£23.01



Description	Size	Code	£
-------------	------	------	---

CANOPIES - ALUMINIUM - MADE TO ORDER - 90MM FRONT HEIGHT



1000w x 902d x 187mm*	ALKENSINGTON1M	£681.00
1500w x 902d x 187mm*	ALKENSINGTON15M	£851.25
2000w x 902d x 187mm*	ALKENSINGTON2M	£1,078.25
2500w x 902d x 187mm*	ALKENSINGTON25M	£1,305.25



Canopy Hood Dims

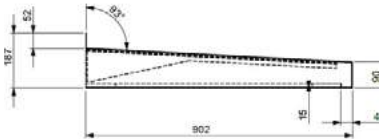

(*rear height including the upstand)

CANOPIES - ALUMINIUM - MADE TO ORDER - 120MM FRONT HEIGHT



1000w x 902d x 217mm*	ALRICHMOND1M	£908.00
1500w x 902d x 217mm*	ALRICHMOND15M	£1,078.25
2000w x 902d x 217mm*	ALRICHMOND2M	£1,305.25
2500w x 902d x 217mm*	ALRICHMOND25M	£1,418.75



Canopy Hood Dims

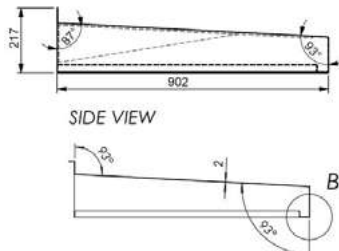

(*rear height including the upstand)



ALUMINIUM CANOPIES

Residential Aluminium door canopies designed for a contemporary look and easy installation.

Powder coated (BBA approved) high quality Aluminium for long life, low maintenance and a choice of 27 standard RAL colours to match doors, window frames or rainwater goods.

Choose from the **27 Standard Matt RAL colours** listed on **page 67** then place your order online and we will call you to confirm the colour required.

Find the installation guide on our website at:

rainclear.info/al-can-in



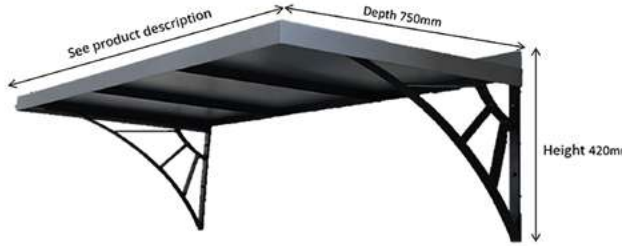

COTSWOLD CANOPY



	Quartz Zinc	Natural Zinc	Anthra Zinc	Copper
1300mm	QZCOTSWOLD1300	NZCOTSWOLD1300	AZCOTSWOLD1300	CCOTSWOLD1300
	£640.00	£640.00	£640.00	£694.00
2000mm	QZCOTSWOLD2000	NZCOTSWOLD2000	AZCOTSWOLD2000	CCOTSWOLD2000
	£1,067.00	£1,067.00	£1,067.00	£1,174.00

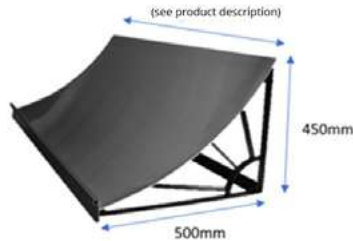

SARAH CANOPY



	Quartz Zinc	Natural Zinc	Anthra Zinc	Copper
1170mm	QZSARAH1170	NZSARAH1170	AZSARAH1170	CSARAH1170
	£640.00	£640.00	£640.00	£680.00
2000mm	QZSARAH2000	NZSARAH2000	AZSARAH2000	CSARAH2000
	£1,200.00	£1,200.00	£1,200.00	£1,270.00



BELGRAVIA CANOPY



	Quartz Zinc	Natural Zinc	Anthra Zinc	Copper
1500mm	QZBEL1500	NZBEL1500	AZBEL1500	CBEL1500
	£1,842.00	£1,842.00	£1,842.00	£2,125.00
2200mm	QZBEL2200	NZBEL2200	AZBEL2200	CBEL2200
	£2,962.00	£2,962.00	£2,962.00	£2,975.00
3000mm	QZBEL3000	NZBEL3000	AZBEL3000	CBEL3000
	£3,684.00	£3,684.00	£3,684.00	£4,250.00

A choice of contemporary or heritage style residential door canopies in Quartz, Natural or Anthra Zinc or Copper for an extremely long life and a little bit of luxury to finish your project in style.

Find installation guidance: a PDF to download and print off and a video to watch, on our website at:

rainclear.info/zc-can-in

Scan now to watch the video or type rainclear.info/zc_can_vid into your favourite browser





BELGRAVIA CANOPY



	Quartz Zinc	Natural Zinc	Anthra Zinc	Copper
1500mm	QZBELCLASIC1500	NZBELCLASIC1500	AZBELCLASIC1500	CBELCLASIC1500
	£2,125.00	£2,125.00	£2,125.00	£2,409.00
2200mm	QZBELCLASIC2200	NZBELCLASIC2200	AZBELCLASIC2200	CBELCLASIC2200
	£2,962.00	£2,962.00	£2,962.00	£3,259.00
3000mm	QZBELCLASIC3000	NZBELCLASIC3000	AZBELCLASIC3000	CBELCLASIC3000
	£3,684.00	£3,684.00	£3,684.00	£4,534.00

Canopies are built on a powder-coated metal framework, then clad in copper or zinc. All of our canopy frames and brackets will need to be drilled by the installer prior to installation to locate the correct fixing points in the substrate. It is important that the installer should ensure that the appropriate fixings are used to suit the substrate. The installer should ensure that the substrate is sound and capable of supporting the appropriate fixings.

- All standard door canopies are constructed with a continental style drip flashing. This will require sealing to the abutment with a proprietary sealer by the installer. Chasing is not required with this product.
- Copper and natural zinc canopies will have a bright finish when leaving our factory. Once the door canopy is installed, the appearance will change with weathering. Copper colouring will react with water and air and the copper will gradually form a beautiful brown patina which creates an additional protection against corrosion. Once installed, both zinc and copper will form a natural patina that requires no maintenance.
- You can clean your canopy if required with cellulose thinners and a soft cloth. **Never use white or methylated spirit or any other product.**

Description	Size	Code	✓	£
-------------	------	------	---	---

CANOPIES - NEXT DAY DELIVERY - ALUMINIUM RECT. CANOPY RH SIDE PANEL PLUS LED STRIP-LIGHT



160x90cm	CBS160SPAG_RH	✓	£1,695.00
200x90cm	CBS200SPAG_RH	✓	£1,795.00

The Aluminium range of door canopies are inspired by Bauhaus architecture's harmoniously balanced geometric shapes and manufactured using high quality aluminium. The RAL 7016 powder coating is environmentally friendly. Choose between canopies with or without integral LED light, and side panels with or without integral stainless steel letterbox.

RAL7016 Anthracite Grey for next day delivery from stock. Other colours available on request but surcharges and longer lead times will apply. Get in touch on 0800 644 44 26 to discuss your requirements.

CANOPIES - NEXT DAY DELIVERY - ALUMINIUM RECT. CANOPY LH SIDE PANEL PLUS LED TRIP-LIGHT



160x90cm	CBS160SPAG_LH	✓	£1,695.00
200x90cm	CBS200SPAG_LH	✓	£1,795.00

Any width, up to 3000mm, can be made to order. Leadtimes will vary.



CANOPIES - NEXT DAY DELIVERY - UPGRADE A BS SIDE PANEL WITH A STAINLESS STEEL LETTERBOX

Stainless Steel Letterbox	CBS90SPLBAG	✓	£150.00
---------------------------	-------------	---	---------

CANOPIES

Description	Size	Code	✓	£
CANOPIES - NEXT DAY DELIVERY - ALUMINIUM CANOPY PLUS LED STRIP-LIGHT				
	160x90cm	CBS160AG	✓	£1,195.00
	200x90cm	CBS200AG	✓	£1,295.00

Available in the two most popular sizes (160 cm and 200 cm) suitable for nearly all types of front door. The ideal combination of function and design.

Standard fixings are included, along with detailed instructions for an easy installation.



Download Installation guidance at rainclear.info/bs_can_vid or scan the QR code:



You can also order these made to order with an integral water spout on the left or right hand side.

✓ = NEXT DAY DELIVERY - order up to noon Mon - Fri for next working day delivery



Description	Size	Code	✓	£
CANOPIES - NEXT DAY DELIVERY - FLOATING GLASS CANOPY WITH LED				
	160 x 94 x 14cm	CFG160LED	✓	£895.00
CANOPIES - NEXT DAY DELIVERY - HD STAINLESS STEEL CANOPY				
	140x80cm Clear Glass 8mm	CHD140CG	✓	£595.00
	160x80cm Clear Glass 10mm	CHD160CG	✓	£695.00
CANOPIES - NEXT DAY DELIVERY - SHIELD PT CANOPY				
	150 x 90 x 22cm - Clear Acrylic	CSHPT150	✓	£195.00
	160 x 90 x 27cm - 4mm Clear Acrylic Top and RAL7016 Anthracite Grey Aluminium Arm and Frame	CSH160AGSTPTGR	✓	£325.00
	Secco 150 x 90 x 22cm - Clear Acrylic Top and RAL7016 Aluminium Support Arm	CSH150AGSTCA	✓	£195.00
CANOPIES - NEXT DAY DELIVERY - ACRYLIC PT/GR SIDE PANEL				
	300 x 600 x 185cm - Clear / RAL7016 Anthracite Grey Frame	CSHPPAGSTCG	✓	£95.00

✓ = STOCK ITEMS NEXT DAY DELIVERY – order up to Noon Mon – Fri for next working day delivery



Description	Size	Code	£
SHADOWLINE CANOPY WITH INTEGRAL DRAINAGE - RAL7016 ANTHRACITE GREY			
with drainage spout to left or right-hand side	145x85cm	CBSSL145AG	£995.00
TIMBERLINE CANOPY WITH INTEGRAL DRAINAGE - RAL7016 ANTHRACITE GREY			
with drainage spout to left or right-hand side	160x90cm	CBSTL160	£995.00
	200x90cm	CBSSL200	£995.00
	250x90cm	CBSSL250	£1,250.00
TIMBERLINE CANOPY WITH SIDE PANEL (AND INTERNAL DRAINAGE) - RAL7016 ANTHRACITE GREY			
with 220cm side panel	160x90cm	CBSTL160SPAG	£1,750.00
	160x90cm	CBSTL160SPAG_RH	£1,950.00
	200x90cm	CBSTL200SPAG	£1,950.00
	200x85cm	CBSTL200SPAG_RH	£2,100.00

Shadowline:

Aluminium RAL7016 Anthracite Grey powder coated frame, black forest white fir-wood, and 8mm safety Glass Shadowline Canopy with Integral Drainage Spout to left or right-hand side - select your preferred configuration before adding to your basket.

- Thickness of roof/side section 12.5 cm
- Weight approx. 45 kg
- Roof area 1.23 m²

Timberline:

Aluminium RAL7016 Anthracite Grey powder coated frame, black forest white fir-wood with Integral Drainage Spout to left or right-hand side - select your preferred configuration before adding to your basket.

Both Shadowline and Timberline:

The wooden sections, which are delivered unassembled, are Black forest white fir, which has an appealing wood tone in its initial natural state but will fade naturally to a silver tone over time. Untreated, the wood is highly weather-resistant and durable.

But you may wish to customise the wooden elements by oiling, varnishing, or painting them with your favourite colour. We recommend any treatment like these should be applied to the components before assembling them.



Description	Size	Code	£
ALUMINIUM RECT. CANOPY 200X90CM WITH 220CM TIMBERLINE SIDE PANEL - ANTHRACITE GREY			
220cm Timberline Right-Hand Side Panel	200x90cm	CBS200TLSPAG_RH	£2,295.00
220cm Timberline Left-Hand Side Panel	200x90cm	CBS200TLSPAG_LH	£2,295.00



Description	Size	Code	£
UPGRADE A BS SIDE PANEL WITH A RAL 7016 ANTHRACITE GREY DEPOT PANEL			
	330mm x 220cm	BS33DEPOTAG	£395.00
	550mm x 220cm	BS55DEPOTAG	£495.00

NEXT DAY DELIVERY!

ON ALL STOCKED PRODUCTS



Order by noon for next working day delivery



Benefits of the SimpleFIT system

- Cast iron system
- Fully painted ready to install
- Traditional 1.8m (6ft) lengths
- 110mm push-fit joints
- Full range of fittings including access pipe and boss connections

Our SimpleFIT soil range, finished in black gloss as standard, is in stock for next day delivery. It can be overpainted or alternatively can be supplied factory pre-painted in your choice of colour, although this will incur a longer delivery time and a surcharge based on the size of the total order.

SimpleFIT soil is an industry leading push fit soil system designed for a lifetime performance. The contemporary cast iron system provides the aesthetic appearance of traditional cast iron soil systems and is suitable for listed properties and conservation projects.



Also available supplied pre-painted to match any RAL or BS colour reference. Colour Match service taken from an existing sample.







Features

- The push-fit installation means substantial savings in labour for each joint. No specialist training is required.
- 50 & 100mm diameter socketless pipes are available in 1.5m, 1.8m & 3m lengths and supplied pre-painted in a black gloss finish.
- The push fit sockets faithfully replicate the appearance of a traditional LCC soil pipe system but incorporate EPDM rubber sealing rings providing a quick and efficient installation. Our specially design gasket relaxing tool and gasket lubricant are the only tools required for jointing.
- Correctly installed and maintained Traditional Express Soil systems will last over 100 years – Fit and forget installation.
- Long life expectancy – cost effective choice. 100% recyclable at the end of its life. Quiet in operation – Low noise levels due to the sound deadening properties of cast iron.

Applicable standards and codes of practice







- BS 416 part 2 – Soil, waste and ventilating pipes and fittings.
- BS EN 681 – 1 Synthetic rubber gaskets.
- BS EN 12056 – Codes of practice for gravity drainage systems, internal buildings.
- Pipes and fittings are supplied ready to install with a two-pack gloss paint exterior finish as standard, suitable for internal and external installations.



Description	Size	Code	✓	£
ROUND PIPES – with 'Push On' socket 1.83m (6ft) – with ears				
	100mm (4")	HT1006FTES	✓	£176.16
	50mm (2")	HT506FTES	✓	£192.05
ROUND PIPES – with 'Push On' socket 1.83m (6ft) – without ears				
	100mm (4")	HT1006FTNES	✓	£172.50
	50mm (2")	HT506FTNES	✓	£190.14
ROUND PIPES – without socket 1.83m (6ft)				
	100mm (4")	HT1006FTPE	✓	£123.64
	50mm (2")	HT506FTPE	✓	£149.37
ACCESS PIPE – with 'Push On' socket				
	100mm (4")	HT100APE	✓	£170.35
	50mm (2")	HT50APE	✓	£147.89
ACCESS PIPE – with 'Push On' socket – without ears				
	100mm (4")	HT100AP	✓	£166.69
	50mm (2")	HT50AP	✓	£145.98
PUSH ON SOCKETS – with ears				
	100mm (4")	HT100ES	✓	£52.52
	50mm (2")	HT50ES	✓	£42.68
PUSH ON SOCKETS – without ears				
	100mm (4")	HT100NES		£48.86
	50mm (2")	HT50NES		£40.77











SimpleFIT | CAST IRON SOIL PIPE SYSTEM

Description	Size	Code	✓	£
PIPE BRACKET – Manufactured in steel*				
	100mm (4")	HT100DPC	✓	£19.38
	50mm (2")	HT50DPC	✓	£18.01
*N.B. Fits around the pipe for use when additional fixing is required				
ROUND PIPE BENDS – with 'Push On' sockets				
92.5° Long Radius				
	100mm (4")	HT100LB87	✓	£153.58
	92.5° Short Radius			
	100mm (4")	HT100SB87	✓	£113.55
	50mm (2")	HT50SB87	✓	£85.23
112.5° Short Radius				
	100mm (4")	HT100SB67	✓	£113.55
135° Short Radius				
	100mm (4")	HT100SB45	✓	£113.55
	50mm (2")	HT50SB45	✓	£85.23
92.5° Long Tail				
	100mm (4")	HT100LT87	✓	£131.65

Stocked fully painted in black – ready to install.
Colour match service also available.





✓ = NEXT DAY DELIVERY – order up to noon Mon – Fri for next working day delivery



Description	Size	Code	✓	£
BOSS CONNECTIONS				
2" BSPT Bolt on				
	100mm (4")	HT100STBP	✓	£95.52
2" BSPT Blank end				
	100mm (4")	HT100BBP	✓	£42.86
2" BSPT Single				
	100mm (4")	HT100BP	✓	£164.89
2" BSPT Double Boss				
	100mm (4")	HT100DBP	✓	£198.79
2" BSPT Double Corner				
	100mm (4")	HT100CBP	✓	£198.79
ACCESS BENDS – with 'Push On' socket				
92.5° Long Radius with access				
	100mm (4")	HT100LB87A	✓	£225.87
92.5° Short Radius with access				
	100mm (4")	HT100SB87A	✓	£182.74
BRANCH – with 'Push On' socket				
92.5° Single Branch				
	100mm (4")	HT100BR87	✓	£197.01
	50mm (2")	HT50BR87	✓	£148.67



SimpleFIT | CAST IRON SOIL PIPE SYSTEM

Description	Size	Code	✓	£
BRANCH – with 'Push On' socket (continued)				
112.5° Single Branch				
	100mm (4")	HT100BR67	✓	£197.00
135° Single Branch				
	100mm (4")	HT100BR45	✓	£197.00
	50mm (2")	HT50BR45	✓	£129.28
92.5° Unequal Branch				
	100 x 50mm (4" x 2")	HT100BRU87	✓	£188.91
135° Unequal Branch				
	100 x 50mm (4" x 2")	HT100BRU45		£188.91
92.5° Double Branch				
	100mm (4")	HT100DBR87	✓	£271.20
ACCESS BRANCH – with 'Push On' socket 92.5° Single Branch with access				
	100mm (4")	HT100ABR87	✓	£267.49
OFFSETS – with 'Push On' socket 130mm offset				
	100mm (4")	HT100OS150	✓	£140.07

Stocked fully painted in black – ready to install.
Colour match service also available.

✓ = NEXT DAY DELIVERY – order up to noon Mon – Fri for next working day delivery



Description	Size	Code	✓	£				
ROUND PIPE BENDS – with 'Push On' sockets' Accessories								
	Blank End Fits inside socket	100mm (4")	HT100BE	✓	£19.73			
		50mm (2")	HT50BE		£16.05			
	Slip Coupler with Ears. Used for jointing existing stack	100mm (4")	HT100SLIP	✓	£63.05			
	Cast Iron Cowl	100mm (4")	HT100COWL	✓	£79.52			
	Galvanised Wire Balloon	100mm (4")	LCC4BAL	✓	£17.25			
	Large Head Fixing Nail. Sold individually	100mm long	DPN	✓	£0.45			
	Fixing Pack Contains 20no coach screws, wall plugs & washers	25mm (1")	DPS	✓	£12.31			
	Tapered Reducer	100mm	HT10050R	✓	£79.05			
		1/2"	PB-50	5.81	✓	PB-50-PA	✓	£6.45
		3/4"	PB-70	5.81	✓	PB-70-PA	✓	£6.45
		1"	PB-100	6.15	✓	PB-100-PA	✓	£6.85
	Cast Iron Spacer Bobbins To suit all eared downpipes	1 1/4"	PB-125	6.15	✓	PB-125-PA	✓	£7.43
		1 1/2"	PB-150	6.68	✓	PB-150-PA	✓	£7.43
		1 3/4"	PB-175	6.68	✓	PB-175-PA	✓	£7.43
		2"	PB-200	6.68	✓	PB-200-PA	✓	£8.07

✓ = NEXT DAY DELIVERY – order up to noon Mon – Fri for next working day delivery



Designed with the installer in mind SimpleFIT makes complete sense for those tricky conservation projects.

The innovative push-fit jointing method significantly reduces installation time, the NEW SimpleFIT range now comes fully painted for immediate installation.

NOTE: COLD WEATHER

- In cold weather you may need to plunge the collar with gasket into hot water to fit.



You can download full installation guide PDFs from our website at: rainclear.info/smft-inst



**NEXT DAY
DELIVERY!**
ON ALL STOCKED PRODUCTS



Order by noon for next working day delivery



TRADITIONAL LCC

Benefits of the Traditional LCC system

- Cast iron system
- Manufactured to original imperial dimensions to BS416
- Traditional 1.8m (6ft) lengths
- Authentic caulked jointing system
- Full range of fittings for ease of installation



Our Traditional LCC Soil System is always supplied in black bitumen finish as per the British Standard BS416 for Soil Products.

Availability

Most of our Traditional LCC Soil System products are in stock for next day delivery, however selected items are manufactured on request. The time scale for these orders are often dependent on the size of the total order, so get in touch to discuss your requirements in plenty of time.

The range provides a comprehensive offering of traditional socket & spigot pipes and fittings for soil and waste installations on the external facade. Once installed it is recommended to over-coat the system to touch-up any scuffs incurred in transit and installation.

The cast iron system offers the ideal solution for conservation and heritage projects where a pipe system is required to blend sympathetically with the heritage building.





Features

- Pipes available from 50mm to 150mm diameters in standard lengths 0.6m, 0.9m, 1.2m and 1.8m.
- All products are based on imperial dimensions so ensuring compatibility with existing installations when replacing or extending pipework.
- Cold caulked joints can be made with 6mm caulking cord and black joint sealant both available from stock. (This method removes the requirement for using naked flames to melt lead on site).
- Traditional LCC Soil pipes are highly resistant to distortion caused by accident or vandalism.
- Correctly installed and maintained Traditional LCC Soil systems can last in excess of 100 years and this long-life expectancy actually makes cast iron a cost-effective choice.
- Minimal maintenance requirements - occasional painting approximately every 10 years (inland areas).
- 100% recyclable at the end of its life.
- Low noise levels due to the sound deadening properties of cast iron.
- Ears can be added to any LCC soil fitting on request.





Description	Size	Code	✓	£
SOIL PIPE – 1.83m (6ft) Length – with ears				
	50mm (2")	LCC26FT	✓	£129.70
	100mm (4")	LCC46FT	✓	£184.76

SOIL PIPE – 1.83m (6ft) Length – without ears				
	50mm (2")	LCC26FTNE	✓	£129.70
	100mm (4")	LCC46FTNE		£184.79

SOIL BRANCH – 92.5° branch				
	100mm (4")	LCC4BR90	✓	£163.20

SOIL BRANCH – 112° branch				
	100mm (4")	LCC4BR112	✓	£163.20

SOIL BRANCH – 112° branch with access				
	100mm (4")	LCC4BRA112	✓	£246.56

SOIL BRANCH – 135° branch				
	100mm (4")	LCC4BR135	✓	£169.08

SOIL BEND – 92.5° bend				
	50mm (2")	LCC2B92		£64.82
	100mm (4")	LCC4B92		£96.34

Description	Size	Code	✓	£
SOIL BEND – 112° bend				
	50mm (2")	LCC2B112	✓	£64.82
	100mm (4")	LCC4B112	✓	£96.34

SOIL BEND – 135° bend				
	100mm (4")	LCC4B135	✓	£96.34

ACCESS PIPE – without ears				
	100mm	LCC4AP	✓	£148.93

SOIL OFFSET – 150mm (6") offset				
	100mm (4")	LCC4OS150	✓	£133.06

SOIL OFFSET – 225mm (9") offset				
	100mm (4")	LCC4OS225	✓	£147.64

SOIL OFFSET – 305mm (12") offset				
	100mm (4")	LCC4OS305	✓	£165.38

SOIL OFFSET – 380mm (15") offset				
	100mm (4")	LCC4OS380	✓	£251.70

✓ = NEXT DAY DELIVERY – order up to noon Mon – Fri for next working day delivery



Description	Size	Code	✓	£	
BOSS CONNECTIONS					
	2" BSPT Bolt on Boss	100mm (4")	LCC4SB50	✓	£98.04
	2" BSPT Single Boss Pipe	100mm (4")	LCC4BP40	✓	203.15
SOCKET					
	With Ears	50mm (2")	LCC2SOC	✓	£40.78
	With Ears	100mm (4")	LCC4SOC	✓	£48.45
PIPE BRACKET					
		50mm (2")	LCC2HBAT	✓	£62.52
	Screw to Wall Fixing Bracket, fits around socket	100mm (4")	LCC4HBAT	✓	£53.04
SUNDRIES					
	Reducer 100mm (4") to 50mm (2") (Fits inside socket)	100mm (4")	LCC4RED	✓	£39.73
	Caulking Cord 4mt required per joint	6mm priced per metre	LCCCORD	✓	£0.46
	Black Bitumen Sealant	290cc tube	LCCSEAL	✓	£10.55
	Large Head Fixing Nail (Sold individually)	100mm long	DPN	✓	£0.45
	Fixing Pack (Contains: 20no coach screws, wall plugs and washers)	100mm long	DPS	✓	£12.31
	Cast Iron Spacer Bobbin	See page 90 for 1/2" to 2", painted and primed		✓	
	Galvanised Wire Balloon	100mm (4")	LCC4BAL	✓	£17.25

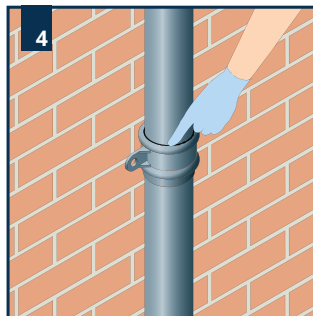
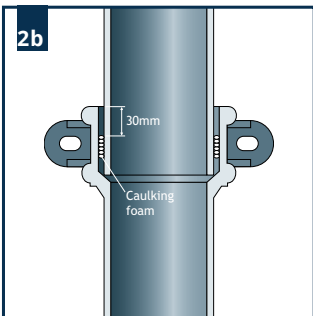
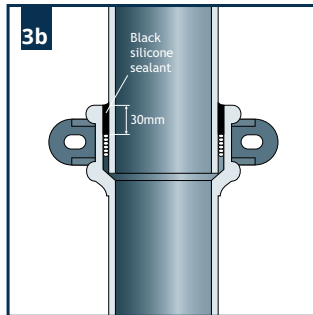
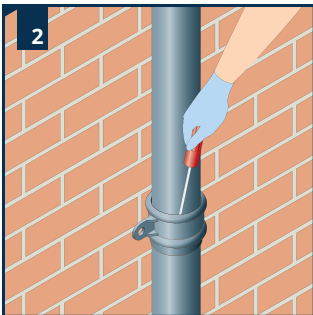
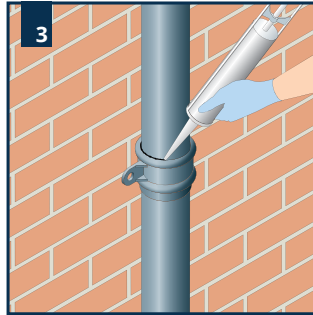
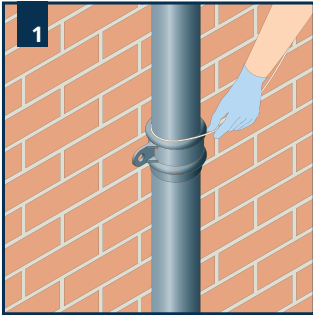

NOTE: We do not recommend over-painting the black bitumen standard finish. If you want your soil system in a colour other than black, to match in with our Cast Iron rainwater systems for example, we recommend our SimpleFIT Soil System.

You can download full installation guide pdfs from our website at: rainclear.info/lcc-inst





The Harmer SML system, with its comprehensive range of fittings and accessories, offers an innovative, whole-building solution for soil, waste and rainwater drainage installations. The system is fully compatible with other market-leading Harmer and Wade drainage products, including roof, floor, shower and channel drains

The Harmer SML socketless lightweight cast iron soil and waste system is BBA certified and meets the Standard of BS EN 877. The SML system combines modern, state-of-the-art drainage technology with the unique characteristics and benefits of cast iron as a preferred material for drainage installations.

Visit the website now, email sales@rainclear.co.uk with your requirements or call us free on 0800 644 44 26.

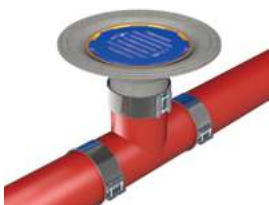

Download the Harmer SML
Lightweight Cast Iron Soil & Waste
Technical Brochure from our
website at:
rainclear.info/tech



NEXT DAY DELIVERY!

ON ALL STOCKED PRODUCTS



Order by noon for next working day delivery



HARMER DRAINAGE

Features of Drainage Products

- Harmer are well known for manufacturing the marketing leading range of rainwater handling and building drainage products
- Most common Aluminium Roof Outlets and Modulock Pedestals held in stock meaning if you order before noon they will be with you the next working day
- Full range of Cast Iron Balcony & Roof Outlets available to order for delivery within 5 working days

HARMER | ALUMINIUM ROOF OUTLETS

Description	Size	Code	✓	£
ALUMINIUM DOME GRATE FLAT ROOF OUTLET with vertical spigot				
	50mm (2")	AV200	✓	£179.12
	75mm (3")	AV300	✓	£205.01
	100mm (4")	AV400	✓	£305.68
	160mm (6")	AV600	✓	£391.59

Description	Size	Code	✓	£
ALUMINIUM DOME GRATE FLAT ROOF OUTLET with vertical 4" BSFT thread				
	100mm (4")	AV200-T	✓	£183.07
	75mm (3")	AV300-T	✓	£234.70
	100mm (4")	AV400-T	✓	£333.99
	160mm (6")	AV600-T	✓	£400.02

ALUMINIUM BALCONY OUTLET with vertical spigot				
	50mm (2")	2BO	✓	£212.12
	75mm (3")	3BO	✓	£243.86
	100mm (4")	4BO	✓	£299.53

ALUMINIUM DOME GRATE FLAT ROOF OUTLET with vertical spigot				
	50mm (2")	AV200-F	✓	£179.12
	75mm (3")	AV300-F	✓	£237.70
	100mm (4")	AV400-F	✓	£333.37
	160mm (6")	AV600-F	✓	£414.64

ALUMINIUM MINI BALCONY OUTLET with vertical spigot				
	50mm (2")	2BO/M	✓	£179.82
	75mm (3")	3BO/M	✓	£179.82

✓ = NEXT DAY DELIVERY – order up to noon Mon – Fri for next working day delivery

HARMER | ALUMINIUM ROOF OUTLETS

HARMER®

BUILDING DRAINAGE

Description	Size	Code	✓	£
-------------	------	------	---	---

ALUMINIUM TWO-WAY PARAPET ROOF MINI OUTLET with BSPT thread



50mm (2")	2TW/M	✓	£237.89
-----------	-------	---	---------

ALUMINIUM TWO-WAY PARAPET ROOF OUTLET with BSPT thread



50mm (2")	2TW	✓	£237.92
-----------	-----	---	---------

75mm (3")	3TW	✓	£307.44
-----------	-----	---	---------

100mm (4")	4TW	✓	£323.30
------------	-----	---	---------

Descrip-	Size	Code	✓	£
----------	------	------	---	---

HARMER THREADED SPIGOT ADAPTOR - 400mm long



50mm (2")	2ADP	✓	£36.62
-----------	------	---	--------

75mm (3")	3ADP	✓	£47.31
-----------	------	---	--------

100mm (4")	4ADP	✓	£62.62
------------	------	---	--------

150mm (6")	6ADP	✓	£105.82
------------	------	---	---------

ALUMINIUM THREADED SPIGOT ADAPTOR -400/600mm



50mm (2")	2ADPA	✓	£48.15
-----------	-------	---	--------

75mm (3")	3ADPA	✓	£59.26
-----------	-------	---	--------

100mm (4")	4ADPA	✓	£79.63
------------	-------	---	--------

150mm (6")	6ADPA	✓	£131.48
------------	-------	---	---------



50mm (2")	2ADPA/600	✓	£72.22
-----------	-----------	---	--------

75mm (3")	3ADPA/600	✓	£88.89
-----------	-----------	---	--------

100mm (4")	4ADPA/600	✓	£119.44
------------	-----------	---	---------

150mm (6")	6ADPA/600	✓	£197.22
------------	-----------	---	---------

HARMER | CAST IRON ROOF OUTLETS

Description	Size	Code	✓	£
-------------	------	------	---	---

CAST IRON TWO-WAY PARAPET ROOF OUTLET - FLAT GRATE



50mm (2")	CTW2/FC	✓	£84.70
-----------	---------	---	--------

75mm (3")	CTW3/FC	✓	£84.70
-----------	---------	---	--------

75mm (3")	CTW4/FC	✓	£84.70
-----------	---------	---	--------

You can download the full Harmer Cast Iron Roof Drainage Outlets PDF from our website at: rainclear.info/hmr_tech



If you don't see what you need here, give us a call on 0800 644 44 26.

✓ = NEXT DAY DELIVERY – order up to noon Mon – Fri for next working day delivery

Description	Code	✓	£
 <p>Harmer C400 - 110mm Cast Iron Vertical Outlet with Dome Grate. Flow Rate of 4.97 litres per second</p>	C400	✓	£126.62
 <p>Harmer C400T - 4" BSP Thread Cast Iron Vertical Outlet with Dome Grate. Flow Rate of 4.97 litres per second</p>	C400T	✓	£110.89
 <p>Harmer C300 - 4" BSP Thread Cast Iron Vertical Outlet with Dome Grate. Complete with clamping ring and reducer making it suitable to connect to 75mm (3") pipework.</p>	C300	✓	£110.63
 <p>Harmer C300T - 4" BSP Thread Cast Iron Vertical Outlet with Dome Grate. Complete with clamping ring and reducer making it suitable to connect to 75mm (3") pipework</p>	C300T	✓	£100.38
 <p>Harmer C200 - 4" BSP Thread Cast Iron Vertical Outlet with Dome Grate. Complete with clamping ring and reducer making it suitable to connect to 50mm (2") pipework</p>	C200	✓	£109.59
 <p>Harmer C200T - 4" BSP Thread Cast Iron Vertical Outlet with Dome Grate. Complete with clamping ring and reducer making it suitable to connect to 50mm (2") pipework</p>	C200T	✓	£99.93
 <p>Harmer C400/F - 110mm Cast Iron Vertical Outlet with Flat Grate. Flow Rate of 4.97 litres per second</p>	C400/F	✓	£126.62
 <p>Harmer C400T/F - 4" BSP Thread Cast Iron Vertical Outlet with Flat Grate. Flow Rate of 4.97 litres per second</p>	C400T/F	✓	£110.89
 <p>Harmer C300/F - 4" BSP Thread Cast Iron Vertical Outlet with Flat Grate. Complete with clamping ring and reducer making it suitable to connect to 75mm (3") pipework</p>	C300/F	✓	£110.63
 <p>Harmer C300T/F - 4" BSP Thread Cast Iron Vertical Outlet with Flat Grate. Complete with clamping ring and reducer making it suitable to connect to 75mm (3") pipework</p>	C300T/F	✓	£100.38
 <p>Harmer C200/F - 4" BSP Thread Cast Iron Vertical Outlet with Flat Grate. Complete with clamping ring and reducer making it suitable to connect to 50mm (2") pipework</p>	C200/F	✓	£109.59
 <p>Harmer C200T/F - 4" BSP Thread Cast Iron Vertical Outlet with Flat Grate. Complete with clamping ring and reducer making it suitable to connect to 50mm (2") pipework</p>	C200T/F	✓	£99.93



MODULOCK PEDESTALS

This range provides adjustment from 37.5mm to 550mm; self leveling heads; a variety of dividers for preset drainage gaps as well as heads without dividers for screw fixing decking battens. An extended key allows for fine adjustment after slabs have been laid.

These adjustable height pedestals are designed for use in terraces, walkways, balconies and ballasted flat roofs.

- Adjustable height
- Self-leveling head
- Self locating
- Compatible & robust



 FREE DELIVERY on orders over £500 Net within 3 – 5 working days

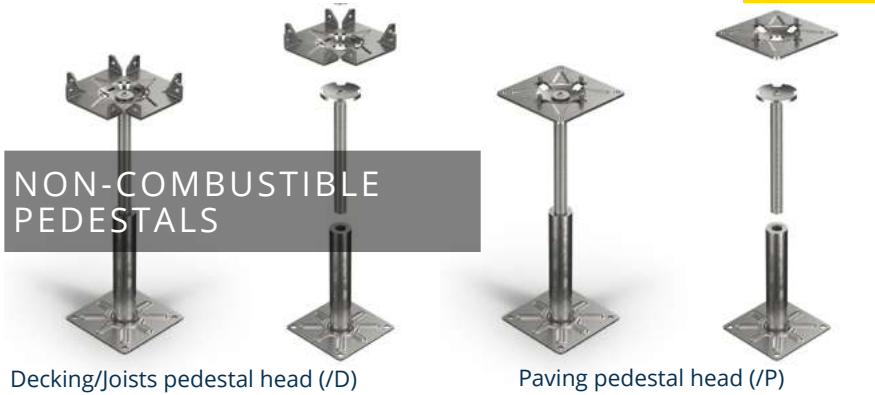

We are now supplying a range of Modulock Non-Combustible Pedestal Supports from Harmer - European Classification (Euroclass) A1 Fire Rated decking and paving pedestals.

Manufactured from steel, provides a super strong support for either decking or flooring joists (D), or a super strong support for paving slabs (P).

Large height-adjustable range available for every application.

- Perfect for terraces, podiums, roof decks, balconies
- Will not crack, split or warp
- Highly durable zinc nickel finish provides excellent corrosion resistance.

Material: Mild Steel
 Finish: Aztec / Zinc / Nickel
 corrosion resistant finish
 Size: 28mm to 458mm
 Compression: 1000kg

Download a Modulock Non-Combustible Pedestal Supports technical data sheets from our website at:

rainclear.info/tech



 FREE DELIVERY on orders over £1,250Net within 3 – 5 working days



WD Series roof outlet in an inverted roof

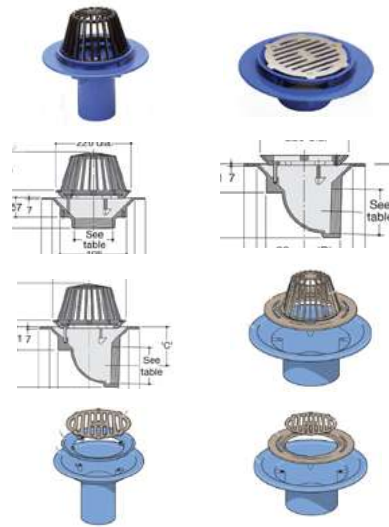

Wade is established as a leading manufacturer of quality drainage products. Much of this success can be attributable to an on-going commitment to put technology to practical use, to generate fresh ideas, and to guarantee quality assured production. Rainclear Drainage have added a comprehensive range of wade cast iron outlet products to the website to provide choice and enable specifier and users to select roof outlets that will meet their requirements.

Wade roof outlets can be connected to all pipework in general use; certain bodies are for direct connection to pipework, others require the use of threaded pipework adaptors or proprietary couplings.

Strength, corrosion resistance and appearance are important considerations when selecting roof outlets. The materials and finish of Wade roof outlets are selected to provide lasting performance and to blend

with surroundings. The products require the minimum of maintenance, but periodic inspection should be carried out to ensure that roof outlets are free from gravel, leaves and other debris which could impair the performance of the system.

Cast iron – BS EN 1561, used for these outlets and their threaded pipework adaptors, is a widely used metal in the drainage industry. Its resistance to corrosion permits extended use under extreme conditions. Castings are coated with a high-grade lacquer paint, applied by full immersion dip, to provide internal and external surface coverage. Paint will gradually wear off. Cast iron parts should be repainted every five years. Some oxidation (surface rusting) is a natural process which does not weaken the core material.

You can download the **Wade Cast Iron Roof Drainage Outlets PDF** from our website at: rainclear.info/wade_outlets



FREE DELIVERY on orders over £500 Net within 2 working days



3m GUTTER



	Galvanised	Black	Anthracite Grey
120x75	GST120BXG ✓	BST120BXG ✓	AGST120BXG ✓
	£40.93	£58.71	£58.71

FASCIA BRACKET



	Galvanised	Black	Anthracite Grey
120x75	GST120BXFB ✓	BST120BXFB ✓	AGST120BXFB ✓
	£16.36	£21.54	£21.54

GUTTER CONNECTOR WITH EPDM SEAL UTTER CONNEC-TOR with EPDM seal



	Galvanised	Black	Anthracite Grey
120x75	GST120BXU ✓	BST120BXU ✓	AGST120BXU ✓
	£14.00	£16.96	£16.96

WRAP-AROUND OUTLET



	Galvanised	Black	Anthracite Grey
120x75	GST120BXRO1 ✓	BST120BXRO1 ✓	AGST120BXRO1 ✓
	£16.50	£27.96	£27.96

STOPEND



	Galvanised	Black	Anthracite Grey
120x75	GST120BXSE ✓	BST120BXSE ✓	AGST120BXSE ✓
	£2.36	£4.86	£4.86

PREFAB OUTLET



	Galvanised	Black	Anthracite Grey
120x75	GST120BXRO2 ✓	BST120BXRO2 ✓	AGST120BXRO2 ✓
	£49.55	£54.48	£54.48

PREFAB STOPEND LEFT-HAND (L) OR RIGHT-HAND (R)



	Galvanised	Black	Anthracite Grey
120x75	GST120BXSEP_ ✓	BST120BXSEP_ ✓	AGST120BXSEP_ ✓
	£47.40	£50.03	£50.03

90 DEGREE ANGLE (INTERNAL (I) OR EXTERNAL (E))



	Galvanised	Black	Anthracite Grey
120x75	GST120BX90_ ✓	BT120BX90_ ✓	AGT120BX90_ ✓
	£32.86.86	£41.00	£41.00



RAINWATER HOPPER HEAD – EMBELLISHED / LONG



	Copper	Quartz Zinc	Natural Zinc	Stainless Steel
80mm	CP80HO1 ✓	QZ80HO1 ✓		
	£382.77	£159.29		
100mm	CP100HO1	QZ100HO1		
	£447.84	£176.86		

RAINWATER HOPPER HEAD – PLAIN BOX



	Copper	Quartz Zinc	Natural Zinc	Stainless Steel
80mm	CP80HO2 ✓	QZ80HO2 ✓	NZ80HO2 ✓	
	£353.98	£143.71	£159.63	
100mm	CP100HO2	QZ100HO2	NZ100HO2	
	£414.16	£160.04	£159.63	



RAINWATER DIVERTER/ACCESS PIPE WITH INTEGRAL LEAF CATCHER



	Copper	Quartz Zinc	Natural Zinc	Stainless Steel
80mm	CP80DIV ✓	QZ80DIV ✓	NZ80DIV ✓	SST80DIV ✓
	£84.96	£95.79	£77.40	£88.72
	Copper	Quartz Zinc	Natural Zinc	Stainless Steel
100mm	CP100DIV	QZ100DIV	NZ100DIV	SST100DIV
	POA	£95.79	£83.16	POA

DOWNPIPE REDUCER (GALV & COPPER ONLY)



	Copper
80 - 55mm	CP80RED ✓
	£43.20

N.B There are no Quartz Zinc, Natural Zinc or Stainless Steel Downpipe Reducers - Pls use the Galv Steel Reducers instead.

✓ = NEXT DAY DELIVERY - order up to noon Mon - Fri for next working day delivery



60MM PROJECTION FIXED OFFSET PIPE



	Copper	Quartz Zinc	Natural Zinc	Stainless Steel
80mm	CP800S60 ✓	QZ800S60 ✓	NZ800S60 ✓	SST800S60 ✓
	£43.71	£34.79	£51.93	£53.22
100mm	CP1000S60	QZ1000S60	NZ1000S60	SST1000S60
	£51.16	£39.99	£55.56	POA

2 PART ADJUSTABLE OFFSET



	Copper	Quartz Zinc	Natural Zinc	Stainless Steel
80mm			NZ80TP700 ✓	
			£55.08	
100mm			NZ100TP700 ✓	
			£71.25	

80MM DOWNPIPE 70° BRANCH



	Copper	Quartz Zinc	Natural Zinc	Stainless Steel
80mm	CP80J ✓	QZ80J ✓	NZ80J ✓	SST80J ✓
	£70.59	£106.64	£82.20	£89.85
100mm	CP100J	QZ100J	NZ100J	SST100J
	£82.61	£71.29	£85.56	POA

SHOE Long heel



	Copper	Quartz Zinc	Natural Zinc	Stainless Steel
80mm	CP80SH ✓	QZ80SH ✓	NZ80SH ✓	SST80SHS ✓
	£33.52	£22.70	£31.74	£35.64
100mm	CP100SH	QZ100SH	NZ100SH	SST100SHS
	£39.25	£33.04	£34.60	POA

DOWNPIPE LOOSE CONNECTOR



	Copper	Quartz Zinc	Natural Zinc	Stainless Steel
80mm	CP80SOC ✓	QZ80SOC ✓	NZ80SOC ✓	SST80SOC
	£12.18	£10.84	£12.29	POA
100mm	CP100SOC	QZ100SOC	NZ100SOC	SST100SOC
	£14.26	£12.45	£14.41	POA



✓ = NEXT DAY DELIVERY – order up to noon Mon – Fri for next working day delivery



3M STEEL DOWNPIPE



	Copper	Quartz Zinc	Natural Zinc	Stainless Steel
80mm	CP80RDP ✓ £175.93		NZ80RDP ✓ £66.20	SST80RD ✓ £144.00
2M	CP80RDP2 ✓ £117.26	QZ80RDP2 ✓ £119.32	NZ100RDP ✓ £71.60	
1M	CP80RDP1 ✓ £58.65	QZ100RDP2 £101.79		
100mm	CP100RDP £205.84			

DOWNPIPE BRACKET WITH M10 BOSS – for use with M10 Screw



	Copper	Quartz Zinc	Natural Zinc	Stainless Steel
80mm	CP80DPC ✓ £13.33	QZ80DPC ✓ £12.43		
100mm	CP100DPC £15.62	QZ100DPC £26.75		

N.B There are no Natural Zinc or Stainless steel Downpipe Brackets - use the Galv Steel standard downpipe bracket or the Galv Steel M10 Boss bracket.

M10 SCREW FOR COPPER DOWNPIPE BRACKET



100mm	140mm	200mm
CPM10SCREW100 ✓ £1.45	CPM10SCREW140 ✓ £1.80	CPM10SCREW200 ✓ £2.49

70° BEND



	Copper	Quartz Zinc	Natural Zinc	Stainless Steel
80mm	CP80B70 ✓	QZ80B70 ✓	NZ80B70 ✓	SST80B70 ✓
	£21.76	£21.89	£19.22	£24.48
100mm	CP100B70	QZ100B70	NZ100B70	SST100B70
	£25.47	£34.61	£21.64	POA

90° BEND



	Copper	Quartz Zinc	Natural Zinc	Stainless Steel
80mm	CP80B90 ✓	QZ80B90 ✓	NZ80B90 ✓	SST80B90 ✓
	£21.76	£32.03	£28.86	£27.32
100mm	CP100B90	QZ100B90	NZ100B90	SST100B90
	£25.47	£44.39	£36.03	POA

✓ = NEXT DAY DELIVERY - order up to noon Mon - Fri for next working day delivery



135° EXTERNAL ANGLES



	Copper	Quartz Zinc	Natural Zinc	Stainless Steel
115mm	CP100135E £138.09			
125mm	CP125135E £138.09	QZ125135E £33.68	✓	
150mm	CP150135E Prices & availability on request			

Other non-standard degrees can also be obtained:
leadtimes TBC

135° INTERNAL ANGLES



	Copper	Quartz Zinc	Natural Zinc	Stainless Steel
115mm	CP100135I £138.09			
125mm	CP125135I £138.09	QZ125135I £151.79	✓	
150mm	CP150135I Prices & availability on request			

Other non-standard degrees can also be obtained:
leadtimes TBC

TOP FIX RAFTER BRACKET (BEND ON SITE*)



N.B There are no Quartz/Natural Zinc or Stainless steel Rafter Brackets - use the Galv Steel standard Rafter brackets or Rise and Fall brackets.

	Copper
115mm	CP100RAFT1 ✓ £25.66
125mm	CP125RAFT1 ✓ £36.31
150mm	CP150RAFT1 Prices & availability on request

SIDE FIX RAFTER BRACKETS



	Copper
115mm	CP100RAFT Prices & availability on request
125mm	CP125RAFT1 £36.31
150mm	CP150RAFT Prices & availability on request



WRAP-AROUND GUTTER OUTLET (80MM OUTLET SIZE)



	Copper	Quartz Zinc	Natural Zinc	Stainless Steel
115mm	CP100HRO1 ✓ £30.81		NZ100HRO1 ✓ £18.16	SST100HRO1 POA
125mm	CP125HRO1 ✓ £29.68	QZ125HRO1 ✓ £79.62	NZ125HRO1 ✓ £19.13	SST125HRO1 ✓ £27.32
150mm	CP150HRO1 Prices & availability on request		NZ150HRO1 ✓ £21.16	SST150HRO1 POA

WRAP-AROUND GUTTER OUTLET (100MM OUTLET SIZE)

150mm	CP150HRO1		NZ150HRO1	
	Prices & availability on request			
190mm	CP190HRO1			
	Prices & availability on request			

PREFAB GUTTER OUTLET (80MM OUTLET SIZE)



	Zinc	Quartz Zinc	Natural Zinc	Stainless Steel
115mm	CP100HRO4 ✓ £98.98		NZ100HRO4 ✓ £69.80	
125mm	CP125HRO4 ✓ £103.55	QZ125HRO4 ✓ £37.78	NZ125HRO4 ✓ £73.99	
150mm			NZ150HRO4 ✓ £52.79	

PREFAB GUTTER OUTLET (100MM OUTLET SIZE)

150mm			NZ150HRO5 ✓ £52.79	
-------	--	--	-----------------------	--

90° EXTERNAL ANGLES



	Copper	Quartz Zinc	Natural Zinc	Stainless Steel
115mm	CP10090E ✓ £63.70		NZ10090E ✓ £48.54	SST10090E POA
125mm	CP12590E ✓ £63.70	QZ12590E ✓ £63.71	NZ12590E ✓ £49.55	SST12590E ✓ £56.51
150mm	CP15090E Prices & availability on request		NZ15090E ✓ £59.35	SST15090E POA
190mm	CP19090E		NZ19090E	
	Prices & availability on request			

90° INTERNAL ANGLES



	Copper	Quartz Zinc	Natural Zinc	Stainless Steel
115mm	CP10090I ✓ £63.70		NZ10090I ✓ £48.54	SST10090I POA
125mm	CP12590I ✓ £63.70	QZ12590I ✓ £63.71	NZ12590I ✓ £49.55	SST12590I ✓ £56.51
150mm	CP15090I Prices & availability on request		NZ15090I ✓ £59.35	SST15090I POA
190mm	CP19090I		NZ19090I	
	Prices & availability on request			

✓ = NEXT DAY DELIVERY – order up to noon Mon – Fri for next working day delivery



3m GUTTER

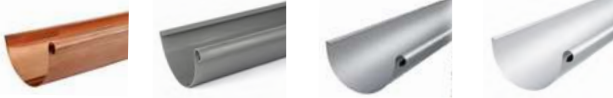

	Copper	Quartz Zinc	Natural Zinc	Stainless Steel
115mm	CP100HRG ✓ £151.51		NZ100HRG ✓ £60.76	SST100HRG POA
125mm	CP125HRG ✓ £171.22	QZ125HRG ✓ £165.15	NZ125HRG ✓ £68.33	SST125HRG ✓ £138.50
150mm	CP150HRG Price & availability on request		NZ150HRG £85.90	SST150HRG POA
190mm	CP190HRG Prices & availability on request		NZ190HRG Prices & availability on request	SST190HRG Prices & availability on request

GUTTER CONNECTOR



	Copper	Quartz Zinc	Natural Zinc	Stainless Steel
115mm	CP100HRU ✓ £21.43		NZ100HRU ✓ £15.16	
125mm	CP125HRU ✓ £22.06		NZ125HRU ✓ £15.80	
150mm	CP150HRU Prices & availability on request		NZ150HRU £16.67	
190mm	CP190HRU Prices & availability on request		NZ190HRU Prices & availability on request	

N.B There are no Quartz Zinc or Stainless Steel Unions - overlap the gutter lengths and use the Glue on page 134.





FASCIA BRACKET



N.B There are no Natural Zinc or Stainless Steel Fascia Brackets - you should use the Galv or ZM Steel ones instead.

	Copper	Quartz Zinc	Natural Zinc	Stainless Steel
115mm	CP100HRFB ✓ £11.26			
125mm	CP125HRFB ✓ £12.18	QZ125HRCB ✓ £8.77		
150mm	CP150HRFB Prices & availability on request			
190mm	CP190HRFB Prices & availability on request			

'PUSH FIT' STOP END GLUE IN STOP END SEAM/GLUE IN STOP ENDS



	Copper	Quartz Zinc	Natural Zinc	Stainless Steel
115mm	CP100HRE1 ✓ £11.08		NZ100HRE1 ✓ £6.40	SST100HRE1 POA
125mm	CP125HRE1 ✓ £11.08	QZ125HRE1 ✓ £4.40	NZ125HRE1 ✓ £7.57	SST125HRE1 ✓ £7.47
150mm	CP150HRE1 Prices & availability on request		NZ150HRE1 £8.38	SST150HRE1 POA
190mm	CP190HRE1 Prices & availability on request		NZ190HRE1 Prices & availability on request	SST190HRE1 Prices & availability on request

*NB: Quartz Zinc, Natural Zinc & Stainless Steel stopends are not 'push-fit' and require 'seaming' or glueing. You'll find the glue online and in this brochure on page 134 and the video instructions for these different methods on our You Tube channel (rainclear.info/youtube)



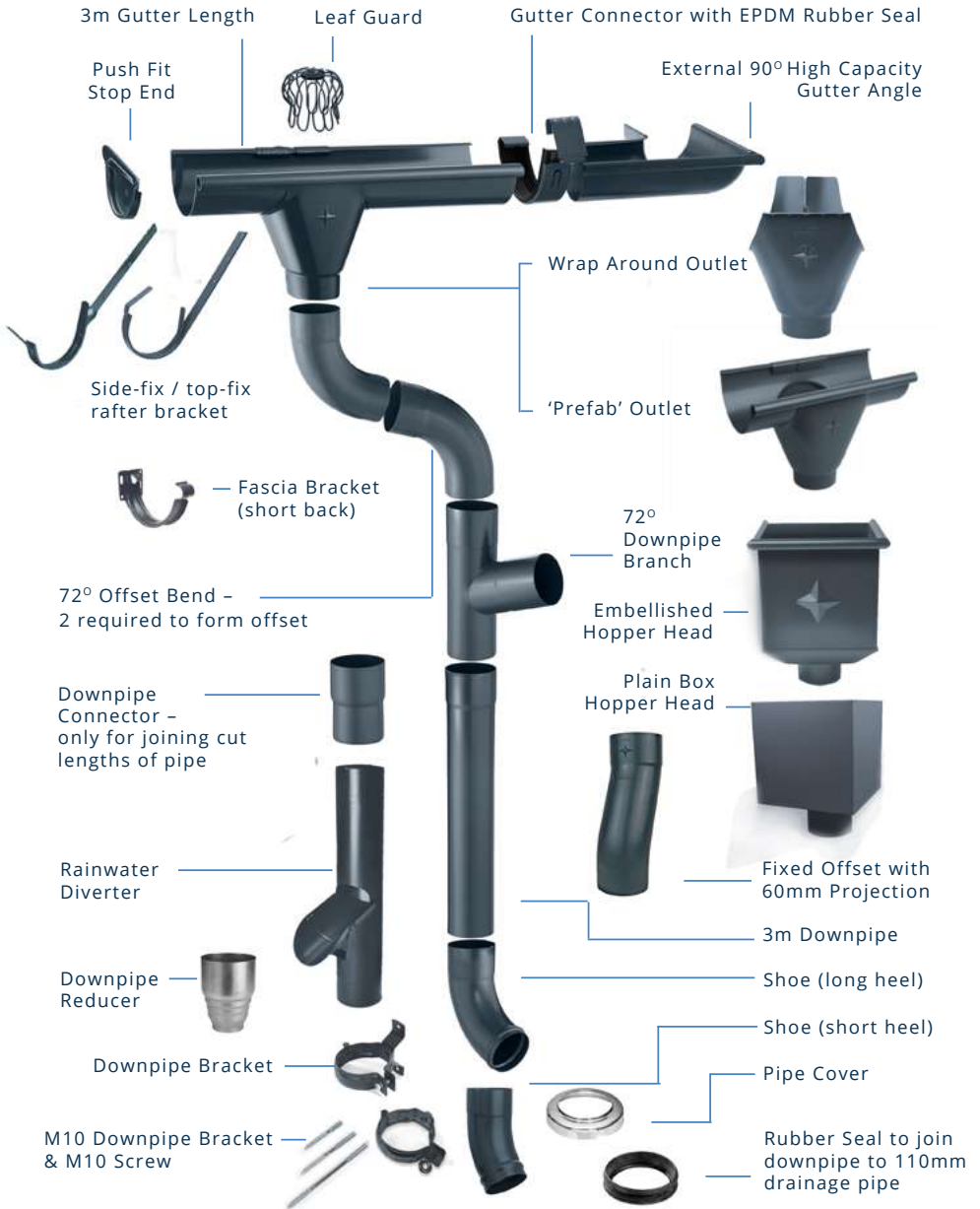

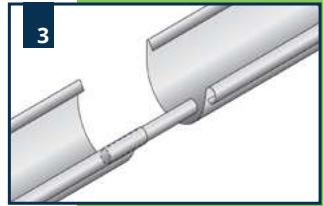
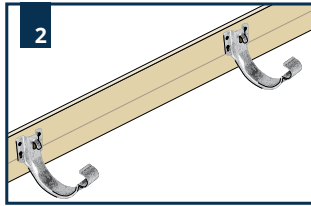
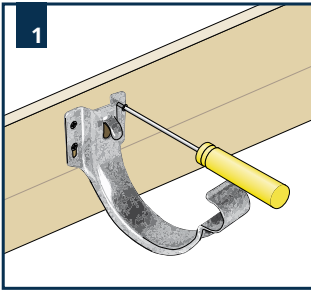

N.B. NEVER CUT WITH A SPINNING BLADE
- zinc fumes released when galv steel is heated are toxic

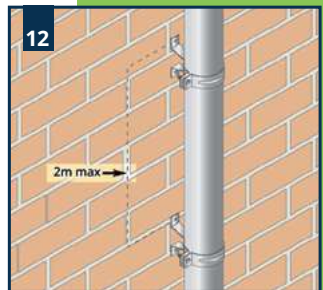
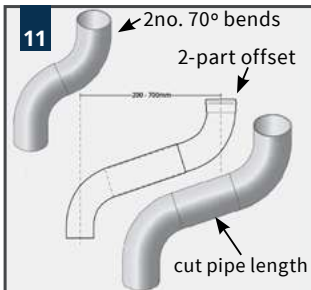
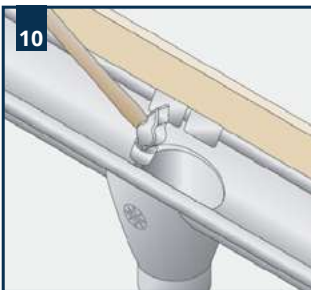
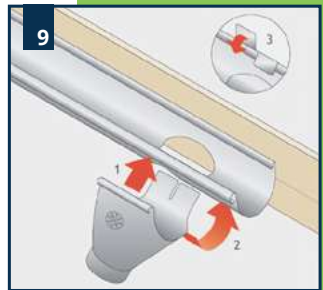
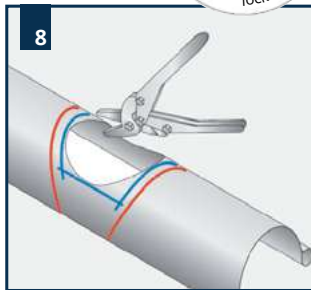
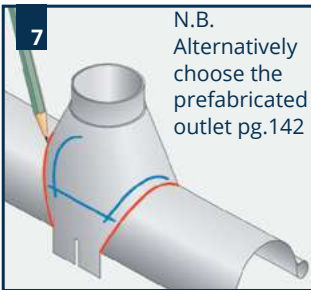
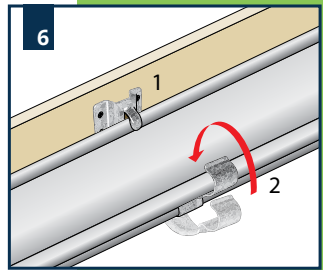
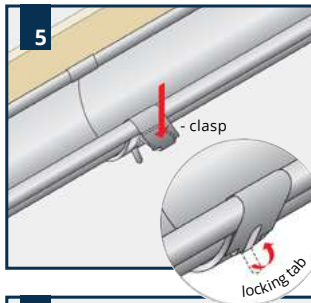
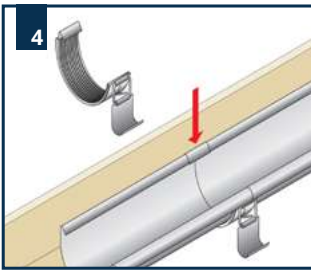

Download installation guide, cutting guide & How to videos from our website at: rainclear.info/inf-inst

N.B. Wear gloves when installing Plain Galv
The Plain Galv will dull over time. Touching it without gloves breaks through the oily surface and starts the weathering process earlier in those areas. In a few months the 'weathering' will catch up all over.



RAINWATER DIVERTER WITH INTEGRAL LEAF CATCHER



	Galvanised	Black	Anthracite Grey	Dusty Grey
80mm	GST80DIV ✓	BST80DIV ✓	AGST80DIV ✓	DGST80DIV ✓
	£53.69	£64.52	£64.52	£64.52
100mm	GST100DIV ✓	BST100DIV ✓	AGST100DIV ✓	DGST100DIV
	£58.49	£64.52	£64.52	POA



RAINWATER COLLECTOR/DIVERTER



	Black	Anthracite Grey	Dusty Grey	Grey White
80mm	BST80COL ✓	AGST80COL ✓	DGST80COL	GWST80COL
	£146.19	£146.19	£146.19	£146.19
100mm	BST100COL	AGST100COL	DGST100COL	GWST100COL
	£146.19	£146.19		POA



UNIVERSAL RAINWATER DIVERTER KIT (with fine mesh filter & on/off function)



	Black	Grey	White	Sepia Brown
All sizes	RC2BL ✓	RC2G ✓	RC2WH ✓	RC2BL ✓
	£110.16	£110.16	£110.16	£110.16



UNIVERSAL DIVERTER WITH TAP (on/off function)



	Grey	Sepia Brown
All sizes	RC1G ✓	RC1BR ✓
	£67.21	£67.21

INFINITY RAINWATER SYSTEMS |

RAINWATER DIVERTER WITH INTEGRAL LEAF CATCHER



Grey White	Sepia Brown	White	Grey Aluminium
GWST80DIV ✓	SBST80DIV ✓	WHST80DIV ✓	GAST80DIV ✓
£64.52	£64.52	£64.52	£64.52

RAINWATER COLLECTOR



Sepia Brown	White	Grey Aluminium
SBST80COL	WHST80COL	GAST80COL
£146.19	£146.19	£146.19

DOWNPIPE RUBBER SEAL



80 - 100mm	100 - 110mm
RS80110 ✓	RS100110 ✓
£12.34	£12.34

DOWNPIPE COVER (GALV ONLY)



80 - 100mm	100 - 110mm
GST80110 ✓	GST100110 ✓
£7.29	£7.29

DOWNPIPE REDUCERS

(GALV & COPPER ONLY)



80 - 55mm
GST80RED ✓
£37.72



100 - 65mm
GST100RED ✓
£37.72

80 to 110mm



100 to 110mm



N.B. Downpipe cover and rubber seal connect downpipes directly to sub-surface drainage pipes as alternative to shoe to open grate.

✓ = NEXT DAY DELIVERY - order up to noon Mon - Fri for next working day delivery



RAINWATER HOPPER HEAD – EMBELLISHED



	Galvanised	Black	Anthracite Grey	Dusty Grey
80mm	GST80HO3 ✓	BST80HO1 ✓	AGST80HO1 ✓	DGST80HO1 ✓
	£134.76	£160.10	£160.10	£160.10
100mm	GST100HO3 ✓	BST100HO1 ✓	AGST100HO1 ✓	DGST100HO1
	£134.76	£160.10	£160.10	£160.10



RAINWATER HOPPER HEAD – PLAIN BOX



	Galvanised	Black	Anthracite Grey	Dusty Grey
80mm	GST80HO2 ✓	BST80HO2 ✓	AGST80HO2 ✓	DGST80HO2 ✓
	£106.41	£133.02	£133.02	£133.02
100mm	GST100HO2 ✓	BST100HO2 ✓	AGST100HO2 ✓	DGST100HO2
	£106.41	£133.02	£133.02	£133.02



RAINWATER HOPPER HEAD – EMBELLISHED & LONG



	Galvanised
80mm	GST80HO1 ✓
	£124.16



✓ = NEXT DAY DELIVERY – order up to noon Mon – Fri for next working day delivery

RAINWATER HOPPER HEAD – EMBELLISHED / LONG



	Grey White	Sepia Brown	White	Grey Aluminium
80mm	GWST80HO1 ✓ £160.10	SBST80HO1 ✓ £160.10	WHST80HO1 ✓ £160.10	GAST80HO1 ✓ £160.10
100mm	GWST100HO1 £160.10	SBST100HO1 £160.10	WHST100HO1 £160.10	GAST100HO1 £160.10

RAINWATER HOPPER HEAD – PLAIN BOX



	Grey White	Sepia Brown	White	Grey Aluminium
80mm	GWST80HO2 ✓ £133.02	SBST80HO2 ✓ £133.02	WHST80HO2 ✓ £133.02	GAST80HO2 ✓ £133.02
100mm	GWST100HO2 £133.02	SBST100HO2 £133.02	WHST100HO2 £133.02	GAST100HO2 £133.02





Long heel shoe Short heel shoe



SHOE Long heel



	Galvanised	Black	Anthracite Grey	
60mm	GST60SH ✓	BST860SH ✓	AGST60SH ✓	
	£15.35	£20.35	£20.35	
80mm	GST80SH ✓	BST80SH ✓	AGST80SH ✓	DGST80SH ✓
	£21.97	£26.45	£26.45	£26.45
100mm	GST100SH ✓	BST100SH ✓	AGST100SH ✓	DGST100SH ✓
	£23.95	£28.85	£28.85	£28.85

DOWNPIPE SHOE short heel

80mm	GST80SHS ✓	BST80SHS ✓	AGST80SHS ✓	DGST80SHS ✓
	£21.97	£26.45	£26.45	£26.45
100mm	GST100SHS ✓			
	£23.95			

DOWNPIPE LOOSE CONNECTOR



	Galvanised	Black	Anthracite Grey	Dusty Grey
80mm	GST80SOC ✓	BST80SOC ✓	AGST80SOC ✓	DGST80SOC ✓
	£9.18	£10.24	£10.24	£10.24
100mm	GST100SOC ✓	BST100SOC ✓	AGST100SOC ✓	DGST100SOC
	£11.26	£12.01	£12.01	£12.01

N.B. Only required when cutting pipe to shorter lengths.

✓ = NEXT DAY DELIVERY – order up to noon Mon – Fri for next working day delivery

SHOE Long heel



	Grey White	Sepia Brown	White	Grey Aluminium
60mm				
80mm	GWST80SH ✓ £26.45	SBST80SH ✓ £26.45	WHST80SH ✓ £26.45	GAST80SH ✓ £26.45
100mm	GWST100SH £28.85	SBST100SH £28.85	WHST100SH £28.85	GAST100SH ✓ £28.85

DOWNPIPE SHOE short heel

	Grey White	Sepia Brown	White	Grey Aluminium
80mm	GWST80SHS ✓ £26.45	SBST80SHS ✓ £26.45	WHST80SHS ✓ £26.45	GAST80SHS ✓ £26.45

DOWNPIPE LOOSE CONNECTOR



	Grey White	Sepia Brown	White	Grey Aluminium
80mm	GWST80SOC ✓ £10.24	SBST80SOC ✓ £10.24	WHST80SOC ✓ £10.24	GAST80SOC ✓ £10.24
100mm	GWST100SOC £12.01	SBST100SOC £12.01	WHST100SOC £12.01	GAST100SOC £12.01





60MM PROJECTION FIXED OFFSET PIPE



	Galvanised	Black	Anthracite Grey	Dusty Grey
60mm	GST60OS60 ✓	BST60OS60 ✓	AGST60OS60 ✓	
	£36.95	£43.26	£43.26	
80mm	GST80OS60 ✓	BST80OS60 ✓	AGST80OS60 ✓	DGST80OS60 ✓
	£36.95	£43.26	£43.26	£43.26
100mm	GST100OS60 ✓	BST100OS60 ✓	AGST100OS60 ✓	DGST100OS60
	£40.91	£46.28	£46.28	£46.28



2 PART ADJUSTABLE OFFSET



	Galvanised	Black	Anthracite Grey	Dusty Grey
80mm	GST80TP700 ✓	BST80TP700 ✓	AGST80TP700 ✓	DGST80TP700 ✓
	£55.08	£86.00	£86.00	£86.00
100mm	GST100TP700 ✓	BST100TP700 ✓		
	£60.67	£91.94		



80MM DOWNPIPE 70° BRANCH



	Galvanised	Black	Anthracite Grey	Dusty Grey
80mm	GST80J ✓	BST80J ✓	AGST80J ✓	DGST80J ✓
	£62.25	£68.50	£68.50	£68.50
100mm	GST100J ✓	BST100J ✓	AGST100J ✓	DGST100J
	£69.06	£71.30	£71.30	£71.30

INFINITY RAINWATER SYSTEMS |

60MM PROJECTION FIXED OFFSET PIPE



	Grey White	Sepia Brown	White	Grey Aluminium
60mm				
80mm	GWST800S60 ✓ £43.26	SBST800S60 ✓ £43.26	WHST800S60 ✓ £43.26	GAST800S60 ✓ £43.26
100mm	GWST1000S60 £46.28	SBST1000S60 £46.28	WHST1000S60 £46.28	GAST1000S60 £46.28

2 PART ADJUSTABLE OFFSET



	Grey White	Sepia Brown	White	Grey Aluminium
80mm	GWST80TP700 POA	SBST80TP700 ✓ £86.00	WHST80TP700 Prices & availability on request	GAST80TP700 Prices & availability on request

Prices & availability on request

80MM DOWNPIPE 70° BRANCH



	Grey White	Sepia Brown	White	Grey Aluminium
80mm	GWST80J ✓ £68.50	SBST80J ✓ £68.50	WHST80J ✓ £68.50	GAST80J ✓ £68.50
100mm	GWST100J £71.30	SBST100J £71.30	WHST100J £71.30	GAST100J £71.30



70° BEND



	Galvanised	Black	Anthracite Grey	Dusty Grey
60mm	GST60B70 ✓	BST60B70 ✓	AGST60B70 ✓	
	£11.18	£12.34	£12.34	
80mm	GST80B70 ✓	BST80B70 ✓	AGST80B70 ✓	DGST80B70 ✓
	£14.86	£16.03	£16.03	£16.03
100mm	GST100B70 ✓	BST100B70 ✓	AGST100B70 ✓	DGST100B70
	£16.73	£18.04	£18.04	£18.04

*Use two bends to make up an offset (Read more: bit.ly/Steel_offsets)



90° BEND



	Galvanised	Black	Anthracite Grey	Dusty Grey
80mm	GST80B90 ✓	BST80B90 ✓	AGST80B90 ✓	DGST80B90 ✓
	£23.17	£24.07	£24.07	£24.07
100mm	GST100B90 ✓	BST100B90 ✓	AGST100B90 ✓	DGST100B90
	£28.24	£30.02	£30.02	£30.02

✓ = NEXT DAY DELIVERY – order up to noon Mon – Fri for next working day delivery



70° BEND



	Grey White	Sepia Brown	White	Grey Aluminium
60mm				
80mm	GWST80B70 ✓ £16.03	SBST80B70 ✓ £16.03	WHST80B70 ✓ £16.03	GAST80B70 ✓ £16.03
100mm	GWST100B70 £18.04	SBST100B70 £18.04	WHST100B70 £18.04	GAST100B70 £18.04

*Use two bends to make up an offset (Read more: bit.ly/Steel_offsets)

90° BEND



	Grey White	Sepia Brown	White	Grey Aluminium
80mm	GWST80B90 ✓ £24.07	SBST80B90 ✓ £24.07	WHST80B90 ✓ £24.07	GAST80B90 ✓ £24.07
100mm	GWST100B90 £30.02	SBST100B90 £30.02	WHST100B90 £30.02	GAST100B90 £30.02





DOWNPIPE BRACKET WITH M10 BOSS – for use with M10 Screw



	Galvanised	Black	Anthracite Grey	Dusty Grey
60mm	GST60M10 ✓	BST60M10 ✓	AGST60M10 ✓	
	£6.13	£7.90	£7.90	
80mm	GST80M10 ✓	BST80M10 ✓	AGST80M10 ✓	DGST80M10 ✓
	£6.13	£8.46	£8.46	£8.46
100mm	GST100M10 ✓	BST100M10 ✓	AGST100M10 ✓	DGST100M10 ✓
	£6.47	£8.80	£8.80	£8.80



M10 GALVANISED STEEL SCREW



	100mm	140mm	200mm
a	60mm	60mm	60mm
b	10mm	30mm	90mm
c	30mm	50mm	50mm

	100mm	140mm	200mm
	M10SCREW100 ✓	M10SCREW140 ✓	M10SCREW200 ✓
	£1.45	£1.80	£2.49

✓ = NEXT DAY DELIVERY – order up to noon Mon – Fri for next working day delivery

DOWNPIPE BRACKET WITH M10 BOSS – for use with M10 Screw



	Grey White	Sepia Brown	White	Grey Aluminium
60mm				
80mm	GWST80M10 ✓ £8.46	SBST80M10 ✓ £8.46	WHST80M10 ✓ £8.46	GAST80M10 ✓ £8.46
100mm	GWST100M10 ✓ £8.80	SBST100M10 ✓ £8.80	WHST100M10 ✓ £8.80	GAST100M10 ✓ £8.80



STAINLESS STEEL M10 SCREW FOR USE WITH INCOMPATIBLE WOODS*



	140mm	200mm	300mm
a	55mm	55mm	70mm
b	35mm	45mm	70mm
c	50mm	100mm	160mm

	140mm	200mm	300mm
	STM10SCREW140 ✓	STM10SCREW200 ✓	STM10SCREW300 ✓
	£2.03	£3.02	£3.88

* Some wood cannot be used with our uncoated galvanised steel and zinc rainwater goods because they contain a high volume of acid.

We do not recommend using the galvanised steel screws with: Douglas Fir, Oak, Chestnut, Larch, Red Cedar, Cedar.
Stainless steel screws are the more suitable alternative.



Size	A
60mm	59mm
80mm	79mm
100mm	99mm

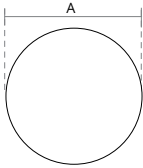

3M STEEL DOWNPIPE

		Galvanised	Black	Anthracite Grey	Dusty Grey
60mm		GST60RDP ✓	BST60RDP ✓	AGST60RDP ✓	
		£30.20	£35.06	£35.06	
80mm		GST80RDP ✓	BST80RDP ✓	AGST80RDP ✓	DGST80RDP ✓
		£48.27	£49.88	£49.88	£49.88
100mm		GST100RDP ✓	BST100RDP ✓	AGST100RDP ✓	DGST100RDP
		£52.44	£59.67	£59.67	£59.67

DOWNPIPE BRACKET



		Galvanised	Black	Anthracite Grey	Dusty Grey
80mm		GST80DPC ✓	BST80DPC ✓	AGST80DPC ✓	DGST80DPC ✓
		£5.22	£5.44	£5.44	£5.44
100mm		GST100DPC ✓	BST100DPC ✓	AGST100DPC ✓	DGST100DPC
		£5.40	£5.82	£5.82	£5.82

✓ = NEXT DAY DELIVERY - order up to noon Mon - Fri for next working day delivery

INFINITY RAINWATER SYSTEMS |

3M STEEL DOWNPIPE



Grey White

Sepia Brown

White

Grey Aluminium

60mm

80mm	GWST80RDP ✓	SBST80RDP ✓	WHST80RDP ✓	GAST80RDP ✓
	£49.88	£49.88	£49.88	£49.88

100mm	GWST100RDP	SBST100RDP	WHST100RDP	GAST100RDP
	£59.67	£59.67	£59.67	£59.67

DOWNPIPE BRACKET



Grey White

Sepia Brown

White

Grey Aluminium

80mm	GWST80DPC ✓	SBST80DPC ✓	WHST80DPC ✓	GAST80DPC ✓
	£5.44	£5.44	£5.44	£5.44

100mm	GWST100DPC	SBST100DPC	WHST100DPC	GAST100DPC
	£5.82	£5.82	£5.82	£5.82



RISE AND FALL BRACKET



Galvanised	
115mm	GST100RFB £28.81 ✓
	GST125RFB £30.71 ✓
150mm	GST150RFB £32.61 ✓
190mm	GST190RFB Prices & availability on request

Please contact us for prices & availability of other colours

GALVANISED FASCIA BRACKET ANGLE ADJUSTER



Galvanised
GSTFBA ✓ £1.86

Only for use with the long back fascia bracket (see copper fascia bracket p.61) still available on request with longer leadtimes. Ask us for more information

ZINC GLUE



Grey
QZGLUE ✓ £26.50



High Tech Adhesive for Quartz Zinc stop ends. Sticks and seals almost everything, Applicable on damp surfaces, UV-resistant, Solvent-free, Extremely high bond strength, Coatable, Odourless

DOWNPIPE LEAF GUARD



	Galvanised	Black Coated	Copper
80mm	GST80LG ✓ £6.53	BST80LG ✓ £6.82	CP80LG ✓ £13.63
	GST100LG ✓ £6.92	BST100LG ✓ £6.82	CP100LG £15.97

✓ = NEXT DAY DELIVERY – order up to noon Mon – Fri for next working day delivery

GUTTER LEAF & DEBRIS GUARDS		Size	Code	£
 <p>Gutter Guard Brush</p>	75mm	BRUSH75	✓	£15.97
	100mm	BRUSH100	✓	£16.79
	125mm	BRUSH125	✓	£19.43
 <p>Gutter Grid Mesh 50mtr Roll c/w 125 clips</p>	For 100mm & 115mm gutters	GRID115	✓	£135.00
	For 125mm gutters	GRID140	✓	£145.00
	For 150mm gutters	GRID155	✓	£160.00



TOUCH-UP PAINT (400ml)					
Black Coated		Anthracite Grey		Dusty Grey	
BSTSPRAY	✓	AGSTSPRAY	✓	DGSTSPRAY	✓
£17.49		£17.49		£17.49	
Sepia Brown		White		Grey Aluminium	
SBGTSPRAY	✓	WHSTSPRAY	✓	GASTSPRAY	✓
£17.49		£17.49		£17.49	



TOP FIX RAFTER BRACKET (BEND ON SITE*)



	Galvanised	Black	Anthracite Grey	Dusty Grey
115mm	GST100RAFT1 ✓ £11.95	BST100RAFT1 ✓ £13.72	AGST100RAFT1 ✓ £13.72	DGST100RAFT1 ✓ £13.72
	GST125RAFT1 ✓ £12.56	BST125RAFT1 ✓ £13.72	AGST125RAFT1 ✓ £13.72	DGST125RAFT1 ✓ £13.72
150mm	GST150RAFT1 ✓ £12.56	BST150RAFT1 ✓ £13.72	AGST150RAFT1 ✓ £13.72	DGST150RAFT1 POA

*N.B. To bend on-site a vice or bracket bender will be required



SIDE FIX RAFTER BRACKETS



	Galvanised	Black
115mm	GST100RAFT ✓ £11.27	BST100RAFT ✓ £15.05
	GST125RAFT ✓ £13.72	BST125RAFT ✓ £15.05
150mm	GST150RAFT ✓ £13.72	BST150RAFT ✓ £15.62

Please contact us for prices & availability of other colours

✓ = NEXT DAY DELIVERY – order up to noon Mon – Fri for next working day delivery



TOP FIX RAFTER BRACKET (BEND ON SITE*)



	Grey White	Sepia Brown	White	Grey Aluminium
115mm	GWST100RAFT1 ✓ £13.72	SBST100RAFT1 ✓ £13.72	WHST100RAFT1 ✓ £13.72	GAST100RAFT1 ✓ £13.72
125mm	GWST125RAFT1 ✓ £13.72	SBST125RAFT1 ✓ £13.72	WHST125RAFT1 ✓ £13.72	GAST125RAFT1 ✓ £13.72





135° EXTERNAL ANGLES



	Galvanised	Black	Anthracite Grey	Dusty Grey
115mm	GST100135E ✓	BST100135E ✓	AGST100135E ✓	DGST100135E
	£89.66	£121.95	£121.95	£121.95
125mm	GST125135E ✓	BST125135E ✓	AGST125135E ✓	DGST125135E
	£92.89	£121.95	£121.95	£121.95
150mm	GST150135E	BST150135E	AGST150135E	DGST150135E
	£98.47	£121.96	£121.96	£121.96
190mm	GST190135E	BST190135E	AGST190135E	DGST190135E
	Prices & availability on request			

Please contact us for prices & availability of other colours/angles



135° INTERNAL ANGLES



	Galvanised	Black	Anthracite Grey	Dusty Grey
115mm	GST100135I ✓	BST100135I ✓	AGST100135I ✓	DGST100135I
	£89.66	£121.95	£121.95	£121.95
125mm	GST125135I ✓	BST125135I ✓	AGST125135I ✓	DGST125135I
	£92.89	£121.95	£121.95	£121.95
150mm	GST150135I	BST150135I	AGST150135I	DGST150135I
	£98.47	£121.96	£121.96	£121.96
190mm	GST190135I	BST190135I	AGST190135I	DGST190135I
	Prices & availability on request			

✓ = NEXT DAY DELIVERY - order up to noon Mon - Fri for next working day delivery

135° EXTERNAL ANGLES



	Grey White	Sepia Brown	White	Grey Aluminium
115mm	GWST100135E £121.95	SBST100135E £121.95	WHST100135E £121.95	GAST100135E £121.95
125mm	GWST125135E £121.95	SBST125135E £121.95	WHST125135E £121.95	GAST125135E £121.95
150mm	GWST150135E £121.95	SBST150135E £121.95	WHST150135E £121.95	GAST150135E £121.95
1135mm	GWST190135E	SBST190135E	WHST190135E	GAST190135E
Prices & availability on request				

Other non-standard degrees can also be obtained:
leadtimes TBC

135° INTERNAL ANGLES



	Grey White	Sepia Brown	White	Grey Aluminium
115mm	GWST100135I £121.95	SBST100135I £121.95	WHST100135I £121.95	GAST100135I £121.95
125mm	GWST125135I £121.95	SBST125135I £121.95	WHST125135I £121.95	GAST125135I £121.95
150mm	GWST150135I £121.95	SBST150135I £121.95	WHST150135I £121.95	GAST150135I £121.95
1135mm	GWST190135I	SBST190135I	WHST190135I	GAST190135I
Prices & availability on request				



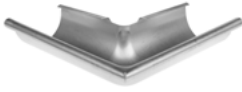

90° EXTERNAL ANGLES



	Galvanised	Black	Anthracite Grey	Dusty Grey
115mm	GST10090E ✓	BST10090E ✓	AGST10090E ✓	DGST10090E ✓
	£36.95	£40.45	£40.45	£40.45
125mm	GST12590E ✓	BST12590E ✓	AGST12590E ✓	DGST12590E ✓
	£37.72	£41.30	£41.30	£41.30
150mm	GST15090E ✓	BST15090E ✓	AGST15090E ✓	DGST15090E
	£43.84	£43.84	£43.84	POA
190mm	GST19090E ✓	BST19090E	AGST19090E	DGST19090E
	£54.40	Prices & availability on request		



90° INTERNAL ANGLES



	Galvanised	Black	Anthracite Grey	Dusty Grey
115mm	GST10090I ✓	BST10090I ✓	AGST10090I ✓	DGST10090I ✓
	£36.95	£40.45	£40.45	£40.45
125mm	GST12590I ✓	BST12590I ✓	AGST12590I ✓	DGST12590I ✓
	£37.72	£41.30	£41.30	£41.30
150mm	GST15090I ✓	BST15090I ✓	AGST15090I ✓	DGST15090I
	£43.84	£49.48	£49.48	POA
190mm	GST19090I ✓	BST19090I	AGST19090I	DGST19090I
	£54.40	Prices & availability on request		

✓ = NEXT DAY DELIVERY - order up to noon Mon - Fri for next working day delivery

90° EXTERNAL ANGLES



	Grey White	Sepia Brown	White	Grey Aluminium
115mm	GWST10090E ✓ £40.45	SBST10090E ✓ £40.45	WHST10090E ✓ £40.45	GAST10090E ✓ £40.45
125mm	GWST12590E ✓ £41.30	SBST12590E ✓ £41.30	WHST12590E ✓ £41.30	GAST12590E ✓ £41.30
150mm	GWST15090E	SBST15090E	WHST15090E	GAST15090E
	Prices & availability on request			
190mm	GWST19090E	SBST19090E	WHST19090E	GAST19090E
	Prices & availability on request			

90° INTERNAL ANGLES



	Grey White	Sepia Brown	White	Grey Aluminium
115mm	GWST10090I ✓ £40.45	SBST10090I ✓ £40.45	WHST10090I ✓ £40.45	GAST10090I ✓ £40.45
125mm	GWST12590I ✓ £41.30	SBST12590I ✓ £41.30	WHST12590I ✓ £41.30	GAST12590I ✓ £41.30
150mm	GWST15090I	SBST15090I	WHST15090I	GAST15090I
	Prices & availability on request			
190mm	GWST19090I	SBST19090I	WHST19090I	GAST19090I
	Prices & availability on request			





WRAP-AROUND GUTTER OUTLET (80MM OUTLET SIZE)



	Galvanised	Black	Anthracite Grey	Dusty Grey
115mm	GST100HRO1 ✓	BST100HRO1 ✓	AGST100HRO1 ✓	DGST100HRO1 ✓
	£14.08	£15.14	£15.14	£15.14
125mm	GST125HRO1 ✓	BST125HRO1 ✓	AGST125HRO1 ✓	DGST125HRO1 ✓
	£15.79	£15.96	£15.96	£15.96
150mm	GST150HRO2 ✓	BST150HRO2 ✓	AGST150HRO2 ✓	DGST150HRO2
	£17.40	£17.64	£17.64	POA
WRAP-AROUND GUTTER OUTLET (100MM OUTLET SIZE)				
150mm	GST150HRO1 ✓	BST150HRO1	AGST150HRO1	DGST150HRO1
	£17.40	£17.64	Prices & availability on request	
190mm	GST190HRO1 ✓	BST190HRO1	AGST190HRO1	DGST190HRO1
	£29.42	Prices & availability on request		
WRAP-AROUND GUTTER OUTLET (60MM OUTLET SIZE)				
150mm	GST100HRO6 ✓	BST100HRO6 ✓	AGST100HRO6 ✓	
	£14.08	£15.14	£15.14	



PREFAB GUTTER OUTLET (80MM OUTLET SIZE)



	Galvanised	Black	Anthracite Grey	Dusty Grey
115mm	GST100HRO4 ✓	BST100HRO4 ✓	AGST100HRO4 ✓	DGST100HRO4 ✓
	£33.08	£33.08	£33.08	£33.08
125mm	GST125HRO4 ✓	BST125HRO4 ✓	AGST125HRO4 ✓	DGST125HRO4 ✓
	£37.72	£37.72	£37.72	£37.72
150mm	GST150HRO4 ✓	BST150HRO4 ✓	AGST150HRO4 ✓	DGST150HRO4 ✓
	£39.60	£39.60	£39.60	POA
PREFAB GUTTER OUTLET (100MM OUTLET SIZE)				
150mm	GST150HRO5 ✓	BST150HRO5 ✓	AGST150HRO5 ✓	Other colours POA
	£39.60	£39.60	£39.60	
PREFAB GUTTER OUTLET (60MM OUTLET SIZE)				
115mm	GST100HRO7 ✓	BST100HRO7 ✓	AGST100HRO7 ✓	
	£33.08	£33.08	£33.08	

WRAP-AROUND GUTTER OUTLET (80MM OUTLET SIZE)



	Grey White	Sepia Brown	White	Grey Aluminium
115mm	GWST100HRO1 ✓ £15.14	SBST100HRO1 ✓ £15.14	WHST100HRO1 ✓ £15.14	GAST100HRO1 ✓ £15.14
125mm	GWST125HRO1 ✓ £15.96	SBST125HRO1 ✓ £15.96	WHST125HRO1 ✓ £15.96	GAST125HRO1 ✓ £15.96
150mm	GWST150HRO1	SBST150HRO1	WHST150HRO1	GAST150HRO2
Prices & availability on request				

WRAP-AROUND GUTTER OUTLET (100MM OUTLET SIZE)

150mm	GWST150HRO1	SBST150HRO1	WHST150HRO1	GAST150HRO1
Prices & availability on request				
190mm	GWST190HRO1	SBST150HRO1	WHST150HRO1	GAST190HRO1
Prices & availability on request				

PREFAB GUTTER OUTLET (80MM OUTLET SIZE)



	Grey White	Sepia Brown	White	Grey Aluminium
115mm	GWST100HRO4 ✓ £33.08	SBST100HRO4 ✓ £33.08	WHST100HRO4 ✓ £33.08	GAST100HRO4 ✓ £33.08
125mm	GWST125HRO4 ✓ £37.72	SBST125HRO4 ✓ £37.72	WHST125HRO4 ✓ £37.72	GAST125HRO4 ✓ £37.72

✓ = NEXT DAY DELIVERY – order up to noon Mon – Fri for next working day delivery





FASCIA BRACKET



	Galvanised	Black	Anthracite Grey	Dusty Grey
115mm	GST100HRFBA ✓	BST100HRFBA ✓	AGST100HRFBA ✓	DGST100HRFBA ✓
	£4.66	£5.34	£5.34	£5.34
125mm	GST125HRFBA ✓	BST125HRFBA ✓	AGST125HRFBA ✓	DGST125HRFBA ✓
	£5.22	£5.44	£5.44	£5.44
150mm	GST150HRFBA ✓	BST150HRFBA ✓	AGST150HRFBA ✓	DGST150HRFBA
	£5.92	£6.99	£6.99	POA
190mm	GST190HRFBA ✓	BST190HRFBA	AGST190HRFBA	DGST190HRFBA
	£10.99	Prices & availability on request		



'PUSH FIT' STOP END



	Galvanised	Black	Anthracite Grey	Dusty Grey
115mm	GST100HRE1 ✓	BST100HRE1 ✓	AGST100HRE1 ✓	DGST100HRE1 ✓
	£4.94	£5.71	£5.71	£5.71
125mm	GST125HRE1 ✓	BST125HRE1 ✓	AGST125HRE1 ✓	DGST125HRE1 ✓
	£5.34	£6.44	£6.44	£6.44
150mm	GST150HRE1 ✓	BST150HRE1 ✓	AGST150HRE1 ✓	DGST150HRE1
	£5.40	£7.04	£7.04	POA
190mm	GST190HRE1 ✓	BST190HRE1	AGST190HRE1	DGST190HRE1
	£9.99	Prices & availability on request		

N.B. Stop ends are not 'push-on' in 190mm Galv

✓ = NEXT DAY DELIVERY - order up to noon Mon - Fri for next working day delivery

FASCIA BRACKET



	Grey White	Sepia Brown	White	Grey Aluminium
115mm	GWST100HRFBA ✓ £5.34	SBST100HRFBA ✓ £5.34	WHST100HRFBA ✓ £5.34	GAST100HRFBA ✓ £5.34
125mm	GWST125HRFBA ✓ £5.44	SBST125HRFBA ✓ £5.44	WHST125HRFBA ✓ £5.44	GAST125HRFBA ✓ £5.44
150mm	GWST150HRFBA	SBST150HRFBA	WHST150HRFBA	GAST150HRFBA
	Prices & availability on request			
190mm	GWST190HRFBA	SBST190HRFBA	WHST190HRFBA	GAST190HRFBA
	Prices & availability on request			

'PUSH FIT' STOP END



	Grey White	Sepia Brown	White	Grey Aluminium
115mm	GWST100HRE1 ✓ £5.71	SBST100HRE1 ✓ £5.71	WHST100HRE1 ✓ £5.71	GAST100HRE1 ✓ £5.71
125mm	GWST125HRE1 ✓ £6.44	SBST125HRE1 ✓ £6.44	WHST125HRE1 ✓ £6.44	GAST125HRE1 ✓ £6.44
150mm	GWST150HRE1	SBST150HRE1	WHST150HRE1	GAST150HRE1
	Prices & availability on request			
190mm	GWST190HRE1	SBST190HRE1	WHST190HRE1	GAST190HRE1
	Prices & availability on request			





3m GUTTER



Size	A	B	C
115mm	114mm	80mm	18mm
125mm	136mm	85mm	18mm
150mm	163mm	100mm	20mm
190mm	203mm	120mm	22mm

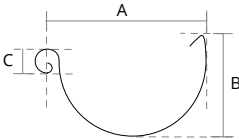

	Galvanised	Black	Anthracite Grey	Dusty Grey
115mm	GST100HRG ✓	BST100HRG ✓	AGST100HRG ✓	DGST100HRG ✓
	£35.07	£38.29	£38.29	£38.29
125mm	GST125HRG ✓	BST125HRG ✓	AGST125HRG ✓	DGST125HRG ✓
	£39.60	£41.05	£41.05	£41.05
150mm	GST150HRG ✓	BST150HRG ✓	AGST150HRG ✓	DGST150HRG
	£50.84	£55.70	£55.70	POA
190mm	GST190HRG ✓	BST190HRG	AGST190HRG	DGST190HRG
	£70.27	Prices & availability on request		

GUTTER CONNECTOR WITH EPDM SEAL UTTER CONNECTOR with EPDM seal



	Galvanised	Black	Anthracite Grey	Dusty Grey
115mm	GST100HRU ✓	BST100HRU ✓	AGST100HRU ✓	DGST100HRU ✓
	£8.05	£9.12	£9.12	£9.12
125mm	GST125HRU ✓	BST125HRU ✓	AGST125HRU ✓	DGST125HRU ✓
	£8.35	£9.74	£9.74	£9.74
150mm	GST150HRU ✓	BST150HRU ✓	AGST150HRU ✓	DGST150HRU
	£9.33	£11.25	£11.25	POA
190mm	GST190HRU ✓	BST190HRU	AGST190HRU	DGST190HRU
	£18.28	Prices & availability on request		

✓ = NEXT DAY DELIVERY - order up to noon Mon - Fri for next working day delivery

3m GUTTER

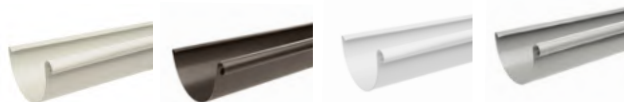

	Grey White	Sepia Brown	White	Grey Aluminium
115mm	GWST100HRG ✓ £38.29	SBST100HRG ✓ £38.29	WHST100HRG ✓ £38.29	GAST100HRG ✓ £38.29
125mm	GWST125HRG ✓ £41.05	SBST125HRG ✓ £41.05	WHST125HRG ✓ £41.05	GAST125HRG ✓ £41.05
150mm	GWST150HRG	SBST150HRG	WHST150HRG	GAST150HRG
	Price & availability on request			
190mm	GWST190HRG	SBST190HRG	WHST190HRG	GAST190HRG
	Prices & availability on request			

GUTTER CONNECTOR



	Grey White	Sepia Brown	White	Grey Aluminium
115mm	GWST100HRU ✓ £9.12	SBST100HRU ✓ £9.12	WHST100HRU ✓ £9.12	GAST100HRU ✓ £9.12
125mm	GWST125HRU ✓ £9.74	SBST125HRU ✓ £9.74	WHST125HRU ✓ £9.74	GAST125HRU ✓ £9.74
150mm	GWST150HRU	SBST150HRU	WHST150HRU	GAST150HRU
	Prices & availability on request			
190mm	GWST190HRU	SBST190HRU	WHST190HRU	GAST190HRU
	Prices & availability on request			



NEXT DAY DELIVERY!

ON ALL STOCKED PRODUCTS



Order by noon for next working day delivery



15 YEARS
PRODUCT
WARRANTY

infinity
RAINWATER SYSTEMS

Benefits of Galvanised Steel

- Lightweight, stylish and long lasting
- Stable material with only 1.2mm/m 100k thermal Expansion
- Easy install with push-fit stop-ends and gutter unions with EPDM rubber seals so no welding, soldering or messy sealant required
- Low Maintenance system with no need to repaint
- Environmentally friendly and fully recyclable
- Wrap around gutter outlets for complete flexibility or prefabricated for ease

INFINITY RAINWATER SYSTEMS



The galvanised steel rainwater system is available in a half round gutter profile which incorporates an integral rolled front edge that gives it both its inherent strength and innovative joining method. It also provides a decorative edge to the gutter while the Deep-flow profile offers additional capacity compared to other systems

The round downpipe system comprises round pipes with swaged joints that simply push together to give a stylish, contemporary finish. Available in 80mm or 100mm diameter to suit the appropriate gutter size.

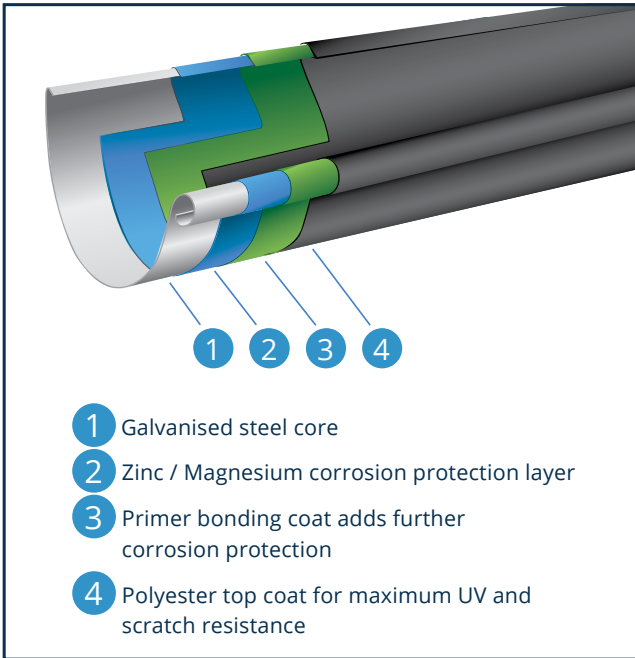

GALVANISED



BLACK
RAL9005M



ANTHRACITE GREY
RAL9016M



DUSTY GREY
RAL7037M



GREY WHITE
RAL9002M



SEPIA BROWN
RAL8019M



WHITE
RAL9016M



GREY ALUMINIUM
RAL 9007M



Clever design makes installation simple









3m GUTTER		UNION	BRACKET	STOPEND
Infinity ZM				
115mm	ZM100HRG ✓	ZM100HRU ✓	ZM100HRFBA ✓	ZM100HRE1 ✓
	£35.07	£8.05	£4.66	£4.94
125mm	ZM125HRG	ZM125HRU	ZM125HRFBA	ZM125HRE1
	£39.60	£8.35	£5.22	£5.34
150mm	ZM150HRG	ZM150HRU	ZM150HRFBA	ZM150HRE1
	£50.84	£9.33	£5.92	£5.40
190mm	ZM190HRG	ZM190HRU	ZM190HRFBA	ZM190HRE1
	£70.27	£18.28	£10.99	£9.99

WRAPAROUND OUTLET		PREFAB OUTLET	90° EXT ANGLE	90° INT ANGLE
Infinity ZM				
(80MM OUTLET SIZE)				
115mm	ZM100HRO1 ✓	ZM100HRO4 ✓	ZM10090E ✓	ZM10090I ✓
	£14.08	£33.08	£36.95	£36.95
125mm	ZM125HRO1	ZM125HRO4	ZM12590E	ZM12590I
	£15.79	£37.72	£37.72	£37.72
150mm	ZM150HRO2	ZM150HRO4	ZM15090E	ZM15090I
	£17.40	£39.60	£43.84	£43.84
(100MM OUTLET SIZE)				
150mm	ZM150HRO1	ZM150HRO5		
	£17.40	£39.60		

✓ = NEXT DAY DELIVERY - order up to noon Mon - Fri for next working day delivery



	3M DOWNPIPE	BRACKET	M10 BRACKET	70° BEND	90° BEND
					
Infinity ZM					
80mm	ZM80RDP ✓ £48.27	ZM80DPC ✓ £5.22	ZM80M10 ✓ £6.13	ZM80B70 ✓ £14.86	ZM80B90 ✓ £23.17
100mm	ZM100RDP £52.44	ZM100DPC £5.40	ZM100M10 £6.47	ZM100B70 £16.73	ZM100B90 £28.24

	60MM OFFSET	70° BRANCH	CONNECTOR	SHOE shortheel	HOPPER
					
Infinity ZM					
80mm	ZM80OS60 ✓ £36.95	ZM80J ✓ £62.25	ZM80SOC ✓ £9.18	ZM80SHS ✓ £21.97	ZM80HO2 ✓ £106.41
100mm	ZM100OS60 ✓ £40.91	ZM100J £69.06	ZM100SOC £11.26	ZM100SHS £23.95	ZM100HO2 £106.41



NEW INFINITY ZM COATING

NEXT DAY DELIVERY!

ON STOCKED SIZES



Order by noon for next working day delivery



25 year
Product
Warranty

infinity
RAINWATER SYSTEMS

Benefits of the NEW ZM Coating

- Our Infinity Galvanised Steel gutters, hoppers and downpipes has been improved with a new, innovative coating of Zinc, Magnesium and Aluminium to produce an even more robust rainwater system 'Infinity 'ZM' Steel' with an improved warranty of 25 years (and 20yrs in some of the harshest environments).
- The combination of zinc, 3.5% aluminium, and 3% magnesium in the 310g/sqm metallic coating provides a breakthrough in corrosion protection - three times better than traditionally galvanised steel (zinc alone coated metal) based on outdoor tests.

NEW Infinity ZM Coating



Our Infinity Galvanised Steel gutters, hoppers and downpipes has been improved with a new, innovative coating of Zinc, Magnesium and Aluminium to produce an even more robust rainwater system 'Infinity 'ZM' Steel' with an improved warranty of 25 years (and 20yrs in some of the harshest environments).



Longer lasting

The combination of zinc, 3.5% aluminium, and 3% magnesium in the 310g/sqm metallic coating provides a breakthrough in corrosion protection - three times better than traditionally galvanised steel (zinc alone coated metal) based on outdoor tests.

With the same self-healing effect once cut with a hacksaw (no spinning blade please - they heat up the metal and release toxic zinc fumes) which ensures excellent edge protection (an unprecedented level of surface and cut-edge protection, even in the most hostile environments).

Longer lasting metallic finish

This version retains its shiny metallic finish for longer. Galvanised steel dulls over time, gradually becoming more 'matt' and weathered - a consequence of the zinc coating being sacrificed to create a hard patina or crust that protects the steel core. The new formula coating means that, while it works in a similar way to protect the core steel, the process takes longer.

And the regular zinc coated Galv steel components came with an oil coating to protect the process from happening faster and unevenly in the places where ungloved fingers had touched the surface during installation. (Eventually the patina would become even/ the same all over). But this no longer an issue with the new Z(n,Al),M(g) formula coating.

Resistant to more aggressive environments

It is now more suitable for industrial environments, and suitable closer to coastal environments than ever before (as well as closer than our rivals can recommend). The alternative for these locations, and those even closer to the coast, has always been to select a colour coated version - like the Aluminium Grey which has a slight sparkle to its finish, and which will not dull over time either.

And it is also now more corrosion resistant to run-off from bituminous materials and woods with high acidic content like Douglas Fir, Oak, Chestnut, Larch, Red cedar, and Cedar. (Materials such as cedar or birch cladding contain volatile alcohols, and oils that have a solvent action on some protective coatings applied to metal - iron and uncoated steel are much more susceptible to the corrosive influence of these woods). The alternative in these situations has always been to select one of the colour coated versions instead.

So now we can say the manufacturer warranty is for 25 years (following their installation guidance - we will supply as a downloadable PDF with every order of an Infinity ZM steel system - please read it!) but with proper care and sensible maintenance the life expectancy should be up to 50 years.

Why not request a sample, a pricelist and/ or a phone call to discuss your project.



NEW INFINITY ZM

GALVANISED STEEL

COPPER

ZINC

STAINLESS STEEL

The future of roofline

