

Installation Guide

General

Skyline powder coated aluminium canopy is suitable for fixing to most exterior finishes. Extra care should be taken when installing to rendered surfaces, and in particular phenolic board render systems, to ensure that an appropriate structural fixing can be achieved to a suitable structural substrate.

Fixings

Structural fixings are not supplied, only use high quality fixings and ensure fixings are suitable for the substrate. (Please consult a structural engineer for advice).



Components

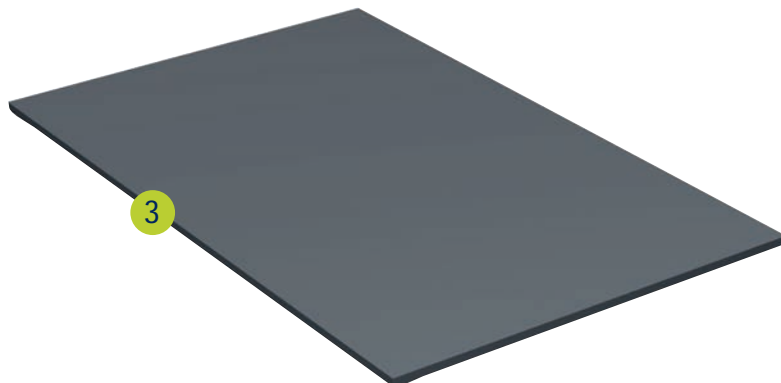
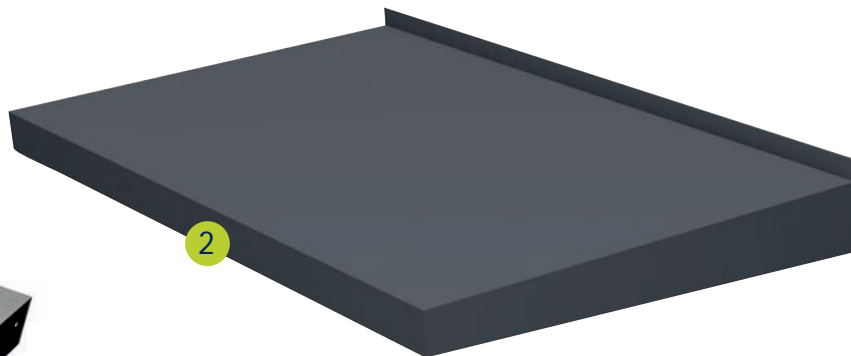
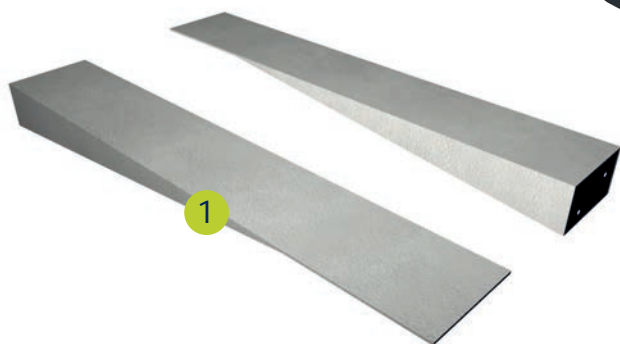

- 1** Wall Bracket
Quantity vary according to width of canopy, refer to last page for details.
- 2** Canopy
- 3** Soffit Panel

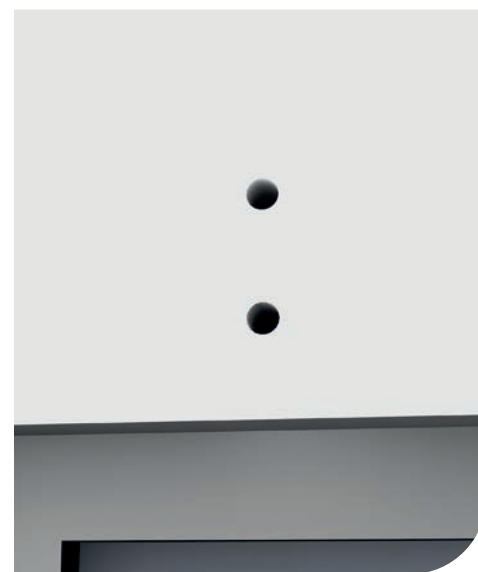
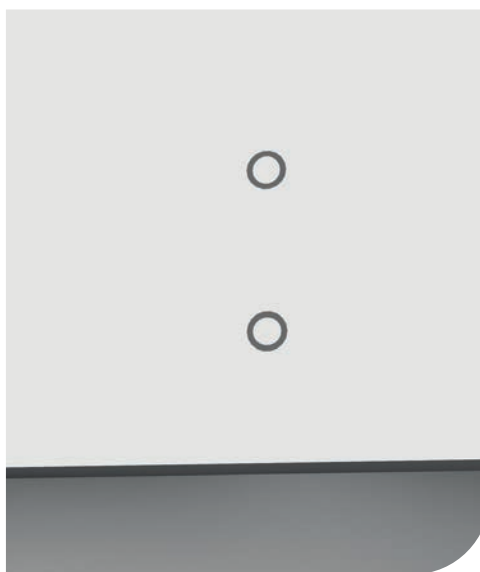

- 1.** Position canopy and mark the wall bracket location. Using the two holes provided mark the fixing holes with a pencil or permanent marker. Drill holes to suit the chosen fixing method, anchor bolts or chemical anchor fixing is recommended.



2. Install the first wall bracket.



3. Level the wall bracket with a spirit level and check the position of the second wall bracket. Fit the second bracket into position. Double check level after fixing, and adjust or pack as required.

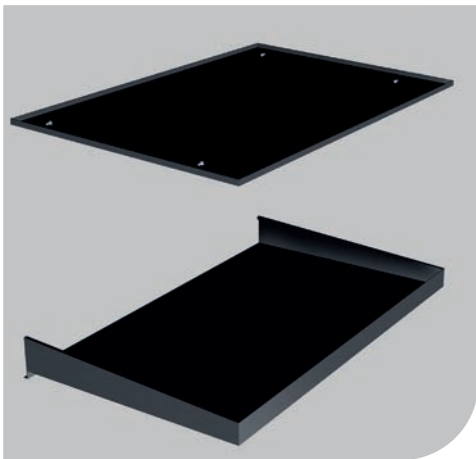
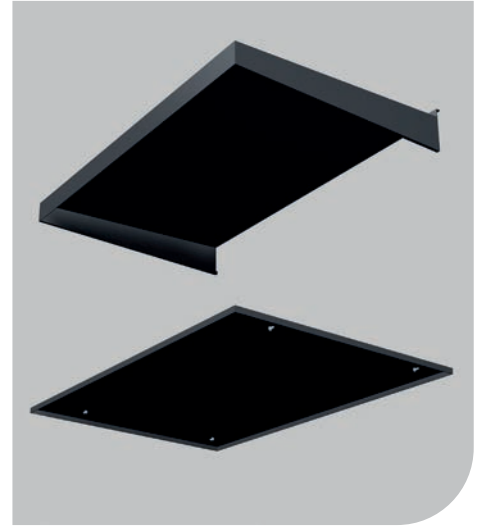

4. Assemble top section and soffit section with 4 self-tapping screws.

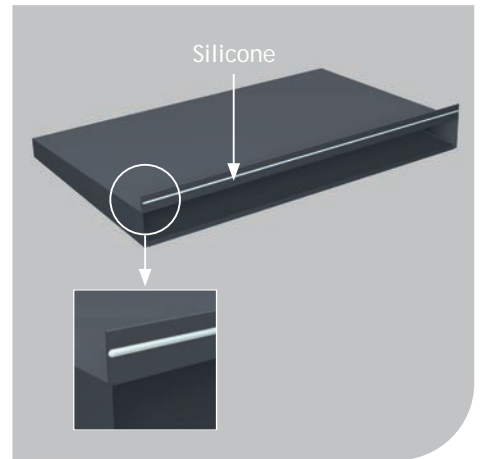
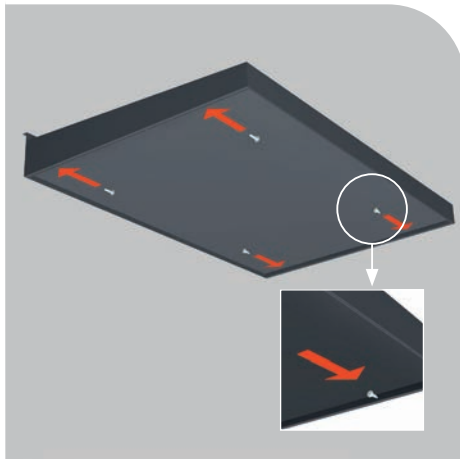

5. Apply a bead of silicone to the back of the upstand.

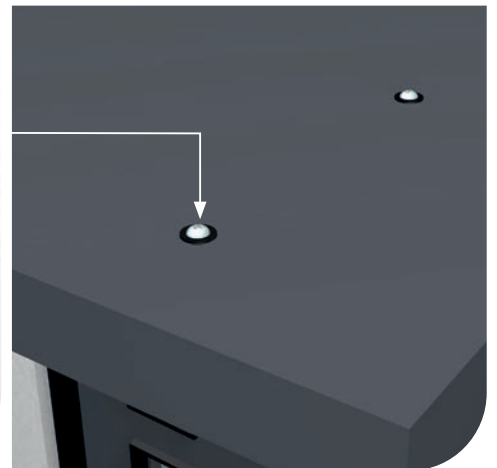
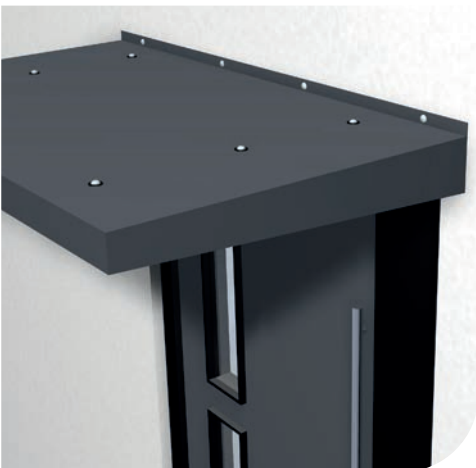

6. Slide assembled canopy onto the wall brackets until the canopy sits tight to the wall. Secure the canopy to the wall brackets using 6x self-tapping screws with rubber-washer (as shown).

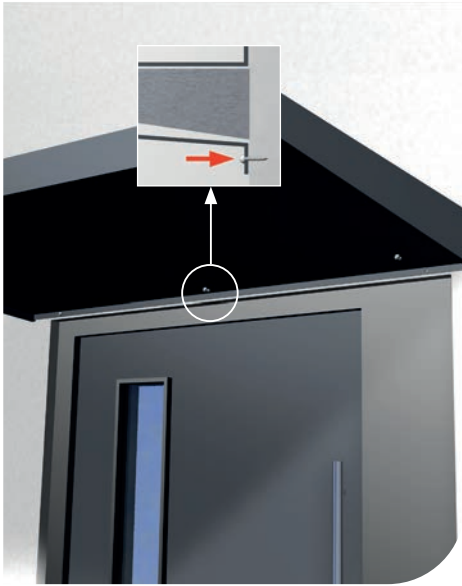

7a. Using the pre-drilled holes, fix through the soffit down stand into the wall.

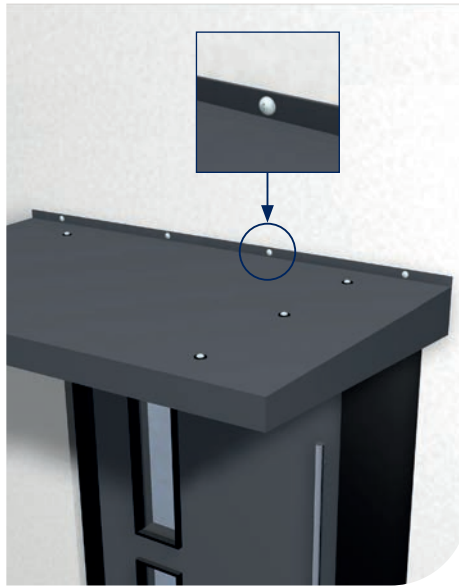

7b. Fix through the upstand into the wall.

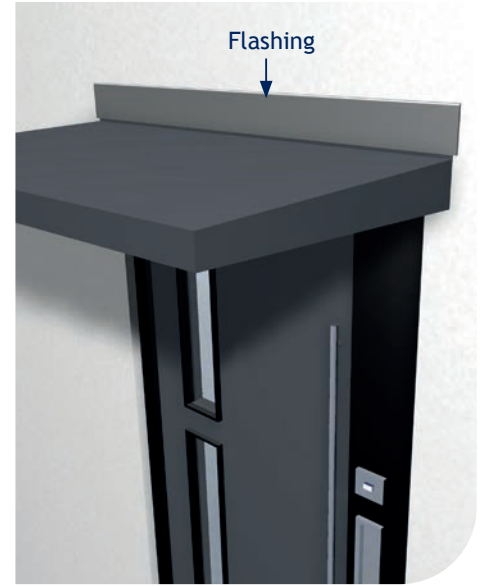

8. Finally, dress the top of canopy with lead or required flashing.

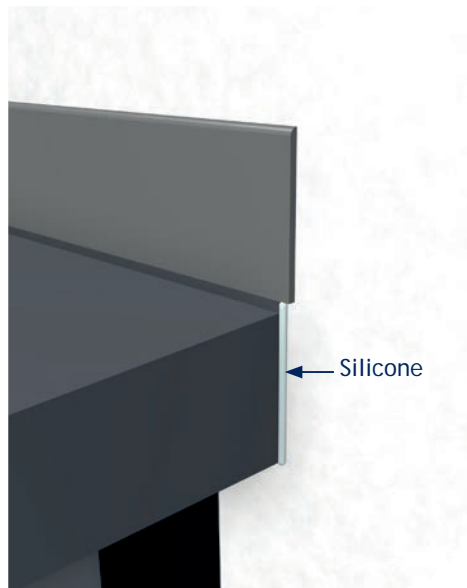

Bracket set up for specific widths of canopy

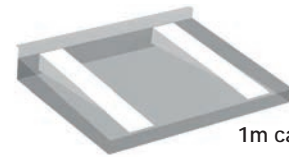
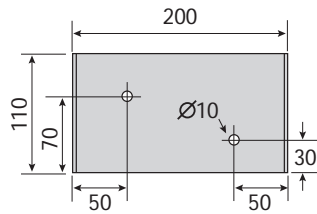

1m canopy = 2 brackets

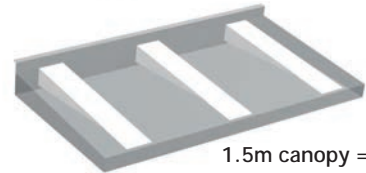

1.5m canopy = 3 brackets

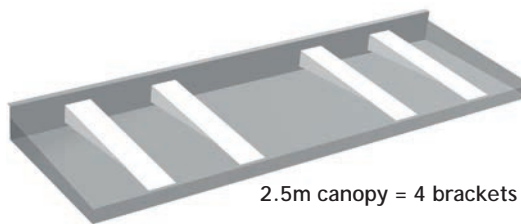

2.5m canopy = 4 brackets

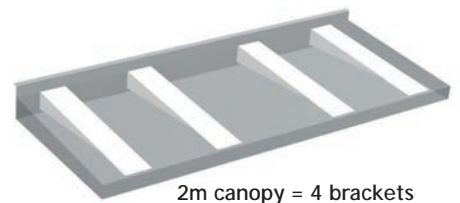

2m canopy = 4 brackets

Optional: seal sides with a high-quality low modulus silicone i.e. Dow Corning or Adshedd Ratcliffe colour matched to the same colour as the canopy, alternatively use a translucent colour.

