



Hargreaves Foundry Drainage

TRADE PRICE LIST



CAST IRON RAINWATER, SOIL & DRAIN SYSTEMS



**PREMIER RAINWATER
& LCC SOIL SYSTEMS**



**TRADITIONAL EXPRESS
PUSH-FIT SOIL SYSTEM**



**MECH 416 MECHANICALLY
JOINTED SOIL SYSTEM**



**PUSH FIT
COUPLINGS
NOW
AVAILABLE**

**HALIFAX SOIL EN 877
SYSTEM**



**PUSH FIT
COUPLINGS
NOW
AVAILABLE**

**HALIFAX DRAIN EN 877
SYSTEM**



**STREET
FURNITURE**

WELCOME...

CAST IRON SYSTEMS FOR RAINWATER, SOIL AND DRAIN



TECHNICAL & SALES SUPPORT

TECHNICAL SERVICES:

INSTALLATION ADVICE

DESIGN ADVICE

DRAINAGE CALCULATIONS

CAD DRAWINGS

DATA SHEETS AND SPECIFICATIONS

SITE VISITS AND SURVEYS ON REQUEST

SALES SERVICES:

CONTRACT MANAGEMENT

TAKE-OFF SERVICE

DIRECT TO SITE DELIVERIES

SAMPLES ON REQUEST

DEDICATED ACCOUNT MANAGER

Hargreaves Foundry Drainage Ltd is one of the UK's leading manufacturers and distributors of Cast Iron products for the construction industry.

Our UK operations and production are in Halifax, Yorkshire, based around our foundry. In addition to the industry leading range of traditional Cast Iron rainwater and soil goods we offer socketless, mechanically jointed Soil and Drain systems and a push fit above ground soil system.

As one of the few working foundries left in the UK we also offer a genuinely bespoke service that includes drawings, pattern making and manufacture.

The Hargreaves Foundry Drainage Price List includes all our systems. Price Lists for individual systems, for instance Halifax Drain, are available as downloadable PDFs from our website.

www.hargreavesfoundry.co.uk & www.soilandrain.co.uk

CONTACTS:

SALES & GENERAL ENQUIRIES: 01422 330607

EMAIL: sales@hargreavesfoundry.co.uk

ACCOUNTS OFFICE: 01422 399112

TECHNICAL SUPPORT: 01422 399113

EMAIL: technical@hargreavesfoundry.co.uk

www.hargreavesfoundry.co.uk

CONTENTS

WELCOME	2	LCC SOIL SUNDRIES	
CONTENTS	3	LCC Soil Sundries	71
BESPOKE	4	TRADITIONAL EXPRESS SOIL	
INFORMATION	5	Pipes & Sockets, Bends	73
PREMIER PAINT	6	Branches	74
		Fittings	75
		Brackets & Sundries	76
RAINWATER PIPES EX STOCK		MECH 416 SOIL	
Round Rainwater Pipes & Fittings	8-9	Pipes & Couplings	78
		Bends	79-80
RAINWATER GUTTERS EX STOCK		Branches	81-82
Plain Half Round Gutters & Fittings	11	Other Fittings	83-84
Beaded Half Round Gutters & Fittings	12	Brackets & Sundries	85
Plain Deep Half Round Gutters & Fittings	13		
Box Gutters & Fittings	14	HALIFAX SOIL	
OG Gutters & Fittings	15	Soil Pipes & Couplings	87
Notts OG Gutters & Fittings	16	Soil Bends	88-89
G46 Moulded Gutters & Fittings	17	Soil Branches	90-91
H16 Moulded Gutters & Fittings	18	Soil Fittings	92-93
		Soil Brackets & Clamps	94-95
		Soil Connectors & Tools	96
RAINWATER SUNDRIES		HALIFAX DRAIN	
Rainwater Sundries	20	Drain Pipes & Couplings, Drain Connectors & Tools	98
		Drain Bends	99
RAINWATER HEADS EX STOCK		Drain Branches	100
Standard Rainwater Heads	22	Drain Fittings	101-102
		Drain Brackets & Clamps	103
RAINWATER PIPES MADE TO ORDER		STREET FURNITURE	
Square Pipes & Fittings	24-25	Antony Gormley Bollards	104
Rectangular Pipes & Fittings	26-28	Street Furniture & Extras	106
Ornamental Earbands	29	Seating & Bins	107
		Grates & Frames	108
		Air Bricks	109
RAINWATER GUTTERS MADE TO ORDER		FREQUENTLY ASKED QUESTIONS	
Radius gutters	51	FAQ's	110
Made To Order Gutters & Fittings	31-58		
		TERMS & CONDITIONS	
RAINWATER HEADS MADE TO ORDER		T&C's	111
Ornamental Heads	60-64		
LCC SOIL			
Soil Pipes & Fittings	66-69		

BESPOKE...



HARGREAVES, LEADING THE WAY WITH THE ABILITY TO MANUFACTURE ANY BESPOKE CASTING.

Hargreaves is a working foundry with skilled pattern makers and moulders, specialist fabricators and painters and over a century of iron casting experience at our site in Halifax, Yorkshire.

Our workforce includes apprentice trained, expert individuals with high levels of manual skills. They are supported by industry experienced management and qualified engineers who can provide manufacturing drawings and technical advice. Our reputation as industry experts is based on this workforce and our proven track record. This is not an idle boast but

a reality supported by our castings, both architectural and drainage, on iconic buildings including the Palace of Westminster, the Elizabeth Tower (Big Ben), Buckingham Palace, Edinburgh Castle, Holyrood House, St James Palace, RMA Sandhurst and many, many others. It can also be attested to through our work for many acclaimed artists, including Sir Antony Gormley.

We can manufacture decorative Rainwater Hoppers, unique gutter profiles, embellishments such as crests, dates, etc. We often get asked to make radius gutters to fit curved rooflines. We can replicate any existing

radius gutter, and have done so many times, ensuring they will fit accurately and function efficiently. These are all requirements that can only be met by a working foundry with its own pattern making shop.

We can make bespoke products to suit any building, ancient or modern, but these skills are most in demand by the conservation, heritage and restoration market. There is no need to resort to the various forms of plastic substitute on offer. Anything that has been cast in the past, for instance during the Victorian era, we can cast. If they could make it back then, we can make it now.

BENEFITS OF CAST IRON

CAST IRON IS TRIED AND TESTED

CAST IRON IS RELIABLE, STRONG AND DURABLE

CAST IRON IS NON COMBUSTIBLE

CAST IRON REQUIRES NO EXTRA LAGGING, FIRE COLLARS ETC

CAST IRON HAS GOOD SOUND DAMPENING PROPERTIES

CAST IRON IS 100% RECYCLABLE

CAST IRON IS SUSTAINABLE AND CAN BE FULLY ACCOUNTED FOR AT A BUILDING'S LIFE END

CAST IRON, UNLIKE PLASTICS, DOES NOT END UP IN LANDFILL

INSTALLATION AND MAINTENANCE

Detailed information about the installation and maintenance of our products is available as downloadable PDFs from both www.hargreavesfoundry.co.uk/cast_iron_drainage and from www.soilandrain.co.uk for Halifax Soil and Drain digital catalogue.

Our customer service team and technical sales managers can answer your enquiries and our Technical dept. can offer additional support if necessary.

In the interests of performance and safety we recommend that all installation work is carried out to appropriate regulations and codes of practice.

QUALITY

The Hargreaves Foundry Drainage Quality Management System is audited twice a year by both BBA and BSI as part of our BS EN 877 certification. Our Halifax Soil and Drain system meets all the requirements of BS EN 877 and has been certified by BSI Kitemark No. KM684754 and BBA certificate number 06/4401. As it conforms to a harmonised construction product standard, this system is also CE and UKCA marked as required.



SUSTAINABILITY

Cast Iron is a sustainable material, 100% recyclable and retaining all its original properties in the process. There is an established after market for Cast Iron which means it will never go to landfill. At the end of a building's lifetime the Cast Iron can be fully accounted for and re-used.

ASSOCIATIONS

Hargreaves Foundry Drainage Ltd is an active member of Metal Gutters Manufacturers Association, the Builders Merchants Federation and the Society of Public Health Engineers.



ORDERS

All prices are in Pound Sterling and subject to VAT at the current rate. Hargreaves standard terms and conditions apply to all orders placed. Carriage charges and any relevant surcharges may be applicable.

DELIVERY

Hargreaves can deliver to merchants or direct to site within an agreed timescale. Enhanced delivery services such as: express delivery, delivery within a specified time slot or Saturday delivery are available but must be agreed in advance with our sales office.

If specialist offloading arrangements are required, for instance Hiab or Moffat, this can be arranged through Hargreaves but must be agreed with the sales office in advance. Any enquiries about delivery AFTER dispatch should be made via deliveries@hargreavesfoundry.co.uk

PREMIER PAINT



PREMIER PAINT

For a detailed guide to our paint finishes please visit www.hargreavesfoundry.co.uk

A good paint finish is vital to the performance and longevity of a Cast Iron rainwater and soil drainage system. Primers and finished coatings protect the underlying substrate by providing a barrier between the Cast Iron and corroding elements. Hargreaves Foundry Drainage offer the following paint finishes, all of which are carried out by paint specialists in factory conditions.

PREMIER PRIMED

The main functions of primers are to;

- Provide a surface that subsequent coats of paint can easily adhere to
- Provide short term protection to the surface until it can be top coated

At Hargreaves the primer paints used are RAL 7024 dark grey in colour and have been specifically formulated to create a barrier to corrosion. The primers can be overcoated with Epoxy, Polyurethane or Acrylic paints.

Products are coated internally and externally. The primer coated supplied products are classed as a transit coating and provide short term protection during delivery and undercover storage.

PREMIER EXTRA

Hargreaves Premier Extra is an exterior coating, high solids, black gloss paint. Black is our standard painted product and available off the shelf on a 3 to 5-day delivery. High solids gloss paints offer

greater durability than paints with a lower solids content.

RAL COLOURS

This bespoke painting service is available on our Premier Rainwater and Traditional Express systems. We can supply any RAL or BS colour reference, we are also able to offer a colour matching service taken from an existing sample.

All RAL coloured products are delivered with a matching tin of touch up paint to make good on any exposure of bare iron as a result of transit and or installation damage.

Due to the bespoke paint requirements, these products are not available on our standard 3 to 5-day delivery. Additional charge applicable.

COASTAL AREAS

Coastal regions are difficult to define, however for the purpose of this document and Hargreaves guidelines, they are described as those areas within 5km of the coast.

The conditions in these areas are more aggressive than those experienced in many other areas. It is therefore very important that any paint chips or impact / installation damage is rectified straight away. Failure to rectify damage at an early stage, will lead to corrosion of the product progressing at an increased rate above what would be seen at an inland location.

To combat this aggressive environment, the overall coating thickness on the Premier Coastal products is much greater. This increased coating thickness forms a longer-lasting barrier between the environment and the substrate thus delaying the onset of corrosion.

It is imperative that a robust maintenance regime is put in place to ensure that no salt or other contaminants are able to build up on the surface of the coating. Irrespective of the volume and quality of coating applied, regular maintenance and repainting will be required to ensure your Cast Iron products can continue to combat the harsh environments that coastal conditions present.

When using our Premier Rainwater, LCC Soil or Traditional Express systems in coastal areas, we advise speaking to us regarding our Coastal paint options. These are designed to provide increased protection levels for these product systems beyond that of the standard paint finish.

Due to the bespoke paint requirements, these products are not available on our standard 3 to 5-day delivery. Additional charge applicable.

TRADITIONAL LCC SOIL

Traditional LCC Soil (BS416) is coated in a bitumen paint. The main components of Bitumen paint are naphtha (petroleum) based.

In the past Bitumen was the main choice for traditional soil drainage due to its resistance to moisture and good coverage of uneven surfaces. Normally this type of finish can't be over painted with other paint types, because not only will harder materials used for over coating tend to crack or craze, but there is also the possibility that the Bitumen will bleed through. We cannot, therefore, recommend overpainting as a viable option.

If the colour is important to your project, we can recommend our Traditional Express (TX) system, (see page 73).



Our ex stock pipes are available off the shelf in sizes 65mm (2.5 inch), 75mm (3 inch) 100mm (4 inch) 150mm (6 inch). In addition to the pipes there is a full range of standard fittings. Cast Iron rainwater pipes have been serving buildings effectively for centuries and continue to offer value for money and reliability.

BS 460 RAINWATER PIPES EX STOCK



ROUND RAINWATER PIPES & FITTINGS

8-9

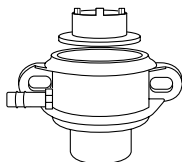
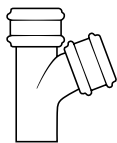
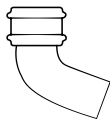
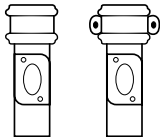
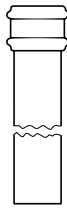
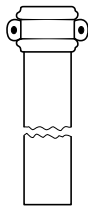

EARED PIPES								
Description	Premier [Primed]				Premier Extra [Black]			
	65mm [2.5"]	75mm [3"]	100mm [4"]	150mm [6"]	65mm [2.5"]	75mm [3"]	100mm [4"]	150mm [6"]
1829mm [6FT] Eared	R2501E £140.32	R3001E £140.32	R4001E £188.32	R6001E £364.40	XR2501E £172.07	XR3001E £172.07	XR4001E £230.97	XR6001E £437.23
1219mm [4FT] Eared	R2504E £125.76	R3004E £125.76	R4004E £157.09	R6004E £332.34	XR2504E £154.24	XR3004E £154.24	XR4004E £192.68	XR6004E £398.80
914mm [3FT] Eared	R2503E £114.60	R3003E £114.60	R4003E £142.05	R6003E £314.12	XR2503E £140.53	XR3003E £140.53	XR4003E £174.24	XR6003E £376.86
610mm [2FT] Eared	R2502E £114.60	R3002E £114.60	R4002E £142.05	R6002E £314.12	XR2502E £140.53	XR3002E £140.53	XR4002E £174.24	XR6002E £376.86
1829mm [6FT] Double Socket Eared	R2501DE £182.52	R3001DE £182.52	R4001DE £244.97	R6001DE £437.23	XR2501DE £228.11	XR3001DE £228.10	XR4001DE £293.95	XR6001DE £524.66

PLAIN PIPES								
Description	Premier [Primed]				Premier Extra [Black]			
	65mm [2.5"]	75mm [3"]	100mm [4"]	150mm [6"]	65mm [2.5"]	75mm [3"]	100mm [4"]	150mm [6"]
1829mm [6FT] Plain	R2501 £131.41	R3001 £131.41	R4001 £179.27	R6001 £355.15	XR2501 £161.16	XR3001 £161.16	XR4001 £219.87	XR6001 £426.40
1219mm [4FT] Plain	R2504 £115.51	R3004 £115.51	R4004 £147.17	R6004 £322.33	XR2504 £141.65	XR3004 £141.65	XR4004 £180.50	XR6004 £386.77
914mm [3FT] Plain	R2503 £103.24	R3003 £103.24	R4003 £130.36	R6003 £294.02	XR2503 £126.62	XR3003 £126.62	XR4003 £159.90	XR6003 £352.77
610mm [2FT] Plain	R2502 £103.24	R3002 £103.24	R4002 £130.36	R6002 £294.02	XR2502 £126.62	XR3002 £126.62	XR4002 £159.90	XR6002 £352.77
1829mm [6FT] Double Socket Plain	R2501D £170.71	R3001D £170.71	R4001D £233.05	R6001D £426.40	XR2501D £213.39	XR3001D £213.39	XR4001D £279.69	XR6001D £511.69

ACCESS PIPES								
Description	Premier [Primed]				Premier Extra [Black]			
	65mm [2.5"]	75mm [3"]	100mm [4"]	150mm [6"]	65mm [2.5"]	75mm [3"]	100mm [4"]	150mm [6"]
Oval Door Eared	R2510E £151.24	R3010E £151.24	R4010E £231.93	R6010E £589.24	XR2510E £171.20	XR3010E £171.20	XR4010E £262.56	XR6010E £648.14
Oval Door Plain	R2510 £109.87	R3010 £109.87	R4010 £214.49	R6010 £545.27	XR2510 £124.38	XR3010 £124.38	XR4010 £242.81	XR6010 £584.48

BENDS								
Description	Premier [Primed]				Premier Extra [Black]			
	65mm [2.5"]	75mm [3"]	100mm [4"]	150mm [6"]	65mm [2.5"]	75mm [3"]	100mm [4"]	150mm [6"]
92.5°	R2520 £41.48	R3020 £50.43	R4020 £71.32	R6020 £345.37	XR2520 £46.98	XR3020 £57.09	XR4020 £80.75	XR6020 £379.86
112.5°	R2521 £41.48	R3021 £50.43	R4021 £71.32	R6021 £345.37	XR2521 £46.98	XR3021 £57.09	XR4021 £80.75	XR6021 £379.86
135°	R2522 £41.48	R3022 £50.43	R4022 £71.32	R6022 £345.37	XR2522 £46.98	XR3022 £57.09	XR4022 £80.75	XR6022 £379.86

BRANCHES								
Description	Premier [Primed]				Premier Extra [Black]			
	65mm [2.5"]	75mm [3"]	100mm [4"]	150mm [6"]	65mm [2.5"]	75mm [3"]	100mm [4"]	150mm [6"]
92.5°	R2530 £80.13	R3030 £88.24	R4030 £104.77	R6030 £357.42	XR2530 £90.72	XR3030 £99.89	XR4030 £118.61	XR6030 £393.10
112.5°	R2531 £80.13	R3031 £88.24	R4031 £104.77	R6031 £357.42	XR2531 £90.72	XR3031 £99.89	XR4031 £118.61	XR6031 £393.10
135°	R2532 £80.13	R3032 £88.24	R4032 £104.77	R6032 £357.42	XR2532 £90.72	XR3032 £99.89	XR4032 £118.61	XR6032 £393.10

LOOSE SOCKETS								
Description	Premier [Primed]				Premier Extra [Black]			
	65mm [2.5"]	75mm [3"]	100mm [4"]	150mm [6"]	65mm [2.5"]	75mm [3"]	100mm [4"]	150mm [6"]
With Spigot Eared	R2550SE £27.80	R3050SE £27.63	R4050SE £37.74	R6050SE £152.88	XR2550SE £33.90	XR3050SE £33.90	XR4050SE £46.29	XR6050SE £168.16
With Spigot Plain	R2550S £24.82	R3050S £24.82	R4050S £36.36	R6050S £143.24	XR2550S £30.42	XR3050S £30.42	XR4050S £44.59	XR6050S £157.49

DIVERTER KITS								
Description	Premier [Primed]				Premier Extra [Black]			
	65mm [2.5"]	75mm [3"]	100mm [4"]	150mm [6"]	65mm [2.5"]	75mm [3"]	100mm [4"]	150mm [6"]
Left Hand Eared [as shown]	R2550DLE £89.52	R3050DLE £89.52	R4050DLE £102.45		XR2550DLE £98.47	XR3050DLE £98.47	XR4050DLE £122.97	
Right Hand Eared	R2550DRE £89.52	R3050DRE £89.52	R4050DRE £102.45		XR2550DRE £98.47	XR3050DRE £98.47	XR4050DRE £122.97	
Plain	R2550D £86.66	R3050D £86.66	R4050D £101.05		XR2550D £94.99	XR3050D £94.99	XR4050D £121.24	

Ears can be fitted to any item on request - POA.

OFFSETS								
Description	Premier [Primed]				Premier Extra [Black]			
	65mm [2.5"]	75mm [3"]	100mm [4"]	150mm [6"]	65mm [2.5"]	75mm [3"]	100mm [4"]	150mm [6"]
75mm [3"] Projection	R2540 £63.50	R3040 £63.50	R4040 £119.78	R6040 £376.90	XR2540 £71.89	XR3040 £71.89	XR4040 £135.63	XR6040 £414.63
115mm [4.5"] Projection	R2541 £63.50	R3041 £63.50	R4041 £119.78	R6041 £376.90	XR2541 £71.89	XR3041 £71.89	XR4041 £135.63	XR6041 £414.63
150mm [6"] Projection	R2542 £63.50	R3042 £63.50	R4042 £119.78	R6042 £376.90	XR2542 £71.89	XR3042 £71.89	XR4042 £135.63	XR6042 £414.63
230mm [9"] Projection	R2543 £73.83	R3043 £73.83	R4043 £145.10	R6043 £428.28	XR2543 £83.59	XR3043 £83.59	XR4043 £164.25	XR6043 £471.10
305mm [12"] Projection	R2544 £86.58	R3044 £86.58	R4044 £145.10	R6044 £489.07	XR2544 £97.99	XR3044 £97.99	XR4044 £164.25	XR6044 £546.72
380mm [15"] Projection	R2545 £172.65	R3045 £172.65	R4045 £235.80	R6045 £675.65	XR2545 £195.45	XR3045 £195.45	XR4045 £266.95	XR6045 £743.26
457mm [18"] Projection	R2546 £202.26	R3046 £202.26	R4046 £286.52	R6046 £776.46	XR2546 £228.95	XR3046 £228.95	XR4046 £324.37	XR6046 £854.17
533mm [21"] Projection	R2547 £252.47	R3047 £252.47	R4047 £380.96	R6047 £793.03	XR2547 £285.80	XR3047 £285.80	XR4047 £419.05	XR6047 £872.36
610mm [24"] Projection	R2548 £252.47	R3048 £252.47	R4048 £380.96	R6048 £793.04	XR2548 £285.80	XR3048 £285.80	XR4048 £419.05	XR6048 £872.36

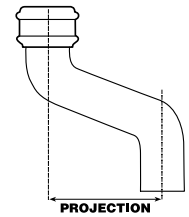

SHOES								
Description	Premier [Primed]				Premier Extra [Black]			
	65mm [2.5"]	75mm [3"]	100mm [4"]	150mm [6"]	65mm [2.5"]	75mm [3"]	100mm [4"]	150mm [6"]
Eared	R2551E £67.82	R3051E £67.82	R4051E £88.24	R6051E £306.05	XR2551E £76.80	XR3051E £76.80	XR4051E £99.89	XR6051E £336.64
Plain	R2551 £58.78	R3051 £58.78	R4051 £79.15	R6051 £297.26	XR2551 £66.56	XR3051 £66.56	XR4051 £89.63	XR6051 £326.92
Anti-Splash Eared	R2552E £125.12	R3052E £125.12	R4052E £169.45	R6052E £535.52	XR2552E £141.63	XR3052E £141.63	XR4052E £191.83	XR6052E £624.50
Anti-Splash Plain	R2552 £113.44	R3052 £113.44	R4052 £158.50	R6052 £531.08	XR2552 £128.44	XR3052 £128.44	XR4052 £179.43	XR6052 £619.23

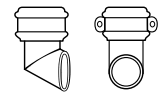

HOLDFAST								
Description	Premier [Primed]				Premier Extra [Black]			
	65mm [2.5"]	75mm [3"]	100mm [4"]	150mm [6"]	65mm [2.5"]	75mm [3"]	100mm [4"]	150mm [6"]
Steel Holdfast	R2555 £11.48	R3055 £11.48	R4055 £12.93	R6055 £21.30	XR2555 £12.65	XR3055 £12.65	XR4055 £14.13	XR6055 £23.39



PIPE BRACKET								
Description	Zinc Plated				Premier Extra [Black]			
	65mm [2.5"]	75mm [3"]	100mm [4"]	150mm [6"]	65mm [2.5"]	75mm [3"]	100mm [4"]	150mm [6"]
"Screw to Wall Supplied with Rubber Gasket"	R2561G £24.12	R3061G £24.12	R4061G £24.85	R6061G £34.14	XR2561G £27.29	XR3061G £27.29	XR4061G £28.16	XR6061G £37.33

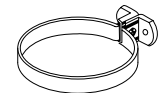

SPACER PLATE								
Description	Premier [Primed]				Premier Extra [Black]			
	65mm [2.5"]	75mm [3"]	100mm [4"]	150mm [6"]	65mm [2.5"]	75mm [3"]	100mm [4"]	150mm [6"]
30mm Projection	R2570 £15.59	R3070 £15.59	R4070 £16.15	R6070 £35.02	XR2570 £19.50	XR3070 £19.50	XR4070 £20.19	XR6070 £43.77

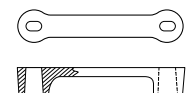

BOBBINS								
Description								
Wooden 30mm Projection					R0001 £2.63			
Metal 13mm Projection					R0002 £7.35			

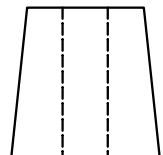

PIPE NAILS								
Description								
75mm [3"] to Suit all Pipe Sizes					R0003 £0.89			
100mm [4"] to Suit all Pipe Sizes					R0004 £0.98			

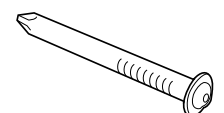

Ears can be fitted to any item on request - POA.



Products can be supplied in any RAL or BS colour.
We can also colour match from customer supplied samples.
Price on application.

We offer eight different gutter profiles as ex stock. These products are all tried and tested and are the most popular choices for traditional gutters. As ex stock items they are available 'off the shelf' on our standard 3 to 5 day delivery or less on our enhanced delivery service. Also available is a full range of brackets and sundries for installation.

RAINWATER GUTTERS EX STOCK



PLAIN HALF ROUND GUTTERS & FITTINGS 11

BEADED HALF ROUND GUTTERS & FITTINGS 12

PLAIN DEEP HALF ROUND GUTTERS & FITTINGS 13

BOX GUTTERS & FITTINGS 14

OG GUTTERS & FITTINGS 15

NOTTS OG GUTTERS & FITTINGS 16

G46 MOULDED GUTTERS & FITTINGS 17

H16 MOULDED GUTTERS & FITTINGS 18

PLAIN HALF ROUND GUTTER								
Description	Premier [Primed]				Premier Extra [Black]			
	100mm [4"]	115mm [4.5"]	125mm [5"]	150mm [6"]	100mm [4"]	115mm [4.5"]	125mm [5"]	150mm [6"]
1829mm [6FT] with external joint	HR4001 £71.47	HR4501 £74.42	HR5001 £86.99	HR6001 £148.28	XHR4001 £88.42	XHR4501 £91.99	XHR5001 £107.47	XHR6001 £163.78
ANGLES								
Description	Premier [Primed]				Premier Extra [Black]			
	100mm [4"]	115mm [4.5"]	125mm [5"]	150mm [6"]	100mm [4"]	115mm [4.5"]	125mm [5"]	150mm [6"]
Square [90°] Left Hand	HR4010 £29.72	HR4510 £31.67	HR5010 £36.96	HR6010 £62.51	XHR4010 £36.44	XHR4510 £38.82	XHR5010 £45.32	XHR6010 £73.75
Square [90°] Right Hand	HR4011 £29.72	HR4511 £31.67	HR5011 £36.96	HR6011 £62.51	XHR4011 £36.44	XHR4511 £38.82	XHR5011 £45.32	XHR6011 £73.75
Obtuse [135°] Left Hand	HR4012 £29.72	HR4512 £31.67	HR5012 £36.96	HR6012 £62.51	XHR4012 £36.44	XHR4512 £38.82	XHR5012 £45.32	XHR6012 £73.75
Obtuse [135°] Right Hand	HR4013 £29.72	HR4513 £31.67	HR5013 £36.96	HR6013 £62.51	XHR4013 £36.44	XHR4513 £38.82	XHR5013 £45.32	XHR6013 £73.75
OUTLETS								
Description	Premier [Primed]				Premier Extra [Black]			
	100mm [4"]	115mm [4.5"]	125mm [5"]	150mm [6"]	100mm [4"]	115mm [4.5"]	125mm [5"]	150mm [6"]
A=65mm [2.5"], B=75mm [3"], C= 100mm [4"]								
Nozzle [Centre Drop]	HR4020A £29.72	HR4520A £31.67	HR5020A £36.96	HR6020B £62.51	XHR4020A £36.44	XHR4520A £38.82	XHR5020A £45.32	XHR6020B £73.75
	HR4020B £29.72	HR4520B £31.67	HR5020B £36.96	HR6020C £62.51	XHR4020B £36.44	XHR4520B £38.82	XHR5020B £45.32	XHR6020C £73.75
Dropead External	HR4021A £29.72	HR4521A £31.67	HR5021A £36.96	HR6021B £62.51	XHR4021A £36.44	XHR4521A £38.82	XHR5021A £45.32	XHR6021B £73.75
	HR4021B £29.72	HR4521B £31.67	HR5021B £36.96	HR6021C £62.51	XHR4021B £36.44	XHR4521B £38.82	XHR5021B £45.32	XHR6021C £73.75
Dropead Internal	HR4022A £29.72	HR4522A £31.67	HR5022A £36.96	HR6022B £62.51	XHR4022A £36.44	XHR4522A £38.82	XHR5022A £45.32	XHR6022B £73.75
	HR4022B £29.72	HR4522B £31.67	HR5022B £36.96	HR6022C £62.51	XHR4022B £36.44	XHR4522B £38.82	XHR5022B £45.32	XHR6022C £73.75
STOPENDS								
Description	Premier [Primed]				Premier Extra [Black]			
	100mm [4"]	115mm [4.5"]	125mm [5"]	150mm [6"]	100mm [4"]	115mm [4.5"]	125mm [5"]	150mm [6"]
External [for spigot]	HR4030 £10.05	HR4530 £12.35	HR5030 £13.05	HR6030 £17.28	XHR4030 £12.33	XHR4530 £15.15	XHR5030 £15.97	XHR6030 £21.21
Internal [for socket]	HR4031 £10.05	HR4531 £12.35	HR5031 £13.05	HR6031 £17.28	XHR4031 £12.33	XHR4531 £15.15	XHR5031 £15.97	XHR6031 £21.21
UNION CLIP								
Description	Premier [Primed]				Premier Extra [Black]			
	100mm [4"]	115mm [4.5"]	125mm [5"]	150mm [6"]	100mm [4"]	115mm [4.5"]	125mm [5"]	150mm [6"]
Union Clip	HR4035 £19.70	HR4535 £23.93	HR5035 £27.66	HR6035 £31.07	XHR4035 £24.16	XHR4535 £29.34	XHR5035 £33.91	XHR6035 £38.09
FASCIA BRACKET								
Description	Premier [Primed]				Premier Extra [Black]			
	100mm [4"]	115mm [4.5"]	125mm [5"]	150mm [6"]	100mm [4"]	115mm [4.5"]	125mm [5"]	150mm [6"]
Fascia Bracket	HR4040 £8.28	HR4540 £8.28	HR5040 £8.96	HR6040 £10.24	XHR4040 £10.15	XHR4540 £10.15	XHR5040 £10.97	XHR6040 £12.55
STEEL BRACKETS								
Description	Galvanised				Premier Extra [Black]			
	100mm [4"]	115mm [4.5"]	125mm [5"]	150mm [6"]	100mm [4"]	115mm [4.5"]	125mm [5"]	150mm [6"]
Top Fixing Rafter Bracket	HR4041 £7.44	HR4541 £7.89	HR5041 £8.37	HR6041 £9.71	XHR4041 £9.13	XHR4541 £9.68	XHR5041 £10.25	XHR6041 £11.93
Side Fixing Rafter Bracket	HR4042 £7.89	HR4542 £8.37	HR5042 £8.90	HR6042 £10.10	XHR4042 £9.68	XHR4542 £10.25	XHR5042 £10.94	XHR6042 £12.39
Rise and Fall Bracket	HR4043 £17.28	HR4543 £17.28	HR5043 £17.69	HR6043 £18.24	XHR4043 £21.63	XHR4543 £21.63	XHR5043 £22.11	XHR6043 £22.80
Square Bar Drive in Bracket	HR4044S £13.28	HR4544S £13.28	HR5044S £13.28	HR6044S £17.69				

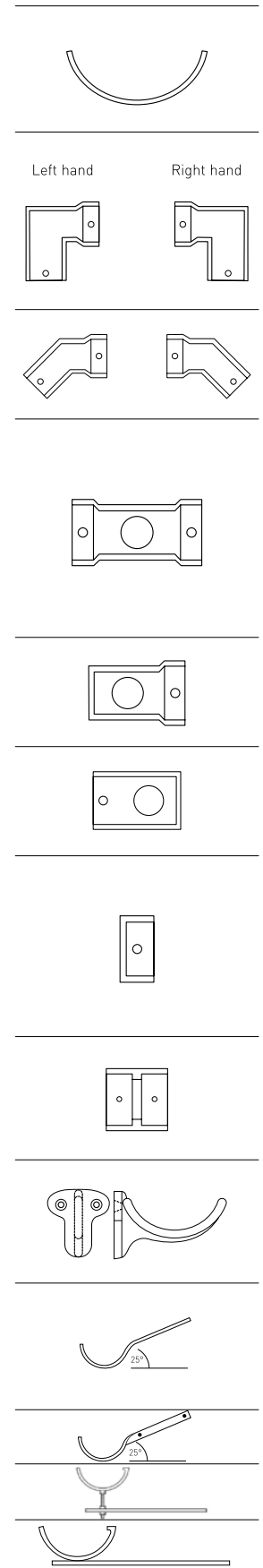

Please see page 20 for sundries.



Products can be supplied in any RAL or BS colour.
We can also colour match from customer supplied samples.
Price on application.

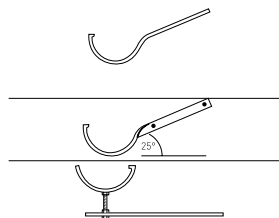
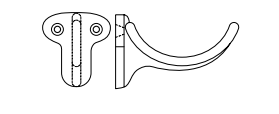
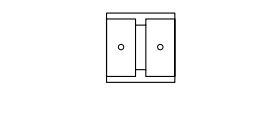
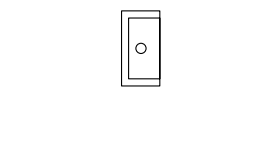
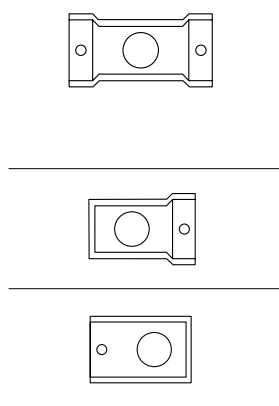
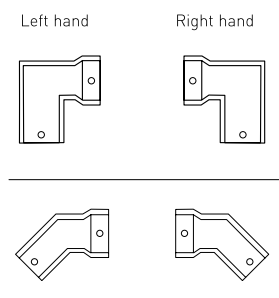
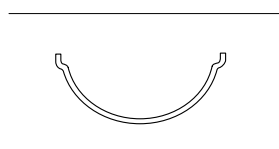

BEADED HALF ROUND GUTTER								
Description	Premier [Primed]				Premier Extra [Black]			
	100mm [4"]	115mm [4.5"]	125mm [5"]	150mm [6"]	100mm [4"]	115mm [4.5"]	125mm [5"]	150mm [6"]
1829mm [6FT] with external joint	HB4001 £71.47	HB4501 £74.42	HB5001 £86.99	HB6001 £178.81	XHB4001 £88.42	XHB4501 £91.98	XHB5001 £107.47	XHB6001 £198.04
ANGLES								
Description	Premier [Primed]				Premier Extra [Black]			
	100mm [4"]	115mm [4.5"]	125mm [5"]	150mm [6"]	100mm [4"]	115mm [4.5"]	125mm [5"]	150mm [6"]
Square [90°] Left Hand	HB4010 £29.72	HB4510 £31.67	HB5010 £36.96	HB6010 £80.22	XHB4010 £36.44	XHB4510 £38.82	XHB5010 £45.32	XHB6010 £98.39
Square [90°] Right Hand	HB4011 £29.72	HB4511 £31.67	HB5011 £36.96	HB6011 £80.22	XHB4011 £36.44	XHB4511 £38.82	XHB5011 £45.32	XHB6011 £98.39
Obtuse [135°] Left Hand	HB4012 £29.72	HB4512 £31.67	HB5012 £36.96	HB6012 £80.22	XHB4012 £36.44	XHB4512 £38.82	XHB5012 £45.32	XHB6012 £98.39
Obtuse [135°] Right Hand	HB4013 £29.72	HB4513 £31.67	HB5013 £36.96	HB6013 £80.22	XHB4013 £36.44	XHB4513 £38.82	XHB5013 £45.32	XHB6013 £98.39
OUTLETS								
Description	Premier [Primed]				Premier Extra [Black]			
	100mm [4"]	115mm [4.5"]	125mm [5"]	150mm [6"]	100mm [4"]	115mm [4.5"]	125mm [5"]	150mm [6"]
A=65mm [2.5"], B=75mm [3"], C= 100mm [4"]								
Nozzle [Centre Drop]	HB4020A £29.72	HB4520A £31.67	HB5020A £36.96	HB6020B £80.22	XHB4020A £36.44	XHB4520A £38.82	XHB5020A £45.32	XHB6020B £98.39
	HB4020B £29.72	HB4520B £31.67	HB5020B £36.96	HB6020C £80.22	XHB4020B £36.44	XHB4520B £38.82	XHB5020B £45.32	XHB6020C £98.39
Drip External	HB4021A £29.72	HB4521A £31.67	HB5021A £36.96	HB6021B £80.22	XHB4021A £36.44	XHB4521A £38.82	XHB5021A £45.32	XHB6021B £98.39
	HB4021B £29.72	HB4521B £31.67	HB5021B £36.96	HB6021C £80.22	XHB4021B £36.44	XHB4521B £38.82	XHB5021B £45.32	XHB6021C £98.39
Drip Internal	HB4022A £29.72	HB4522A £31.67	HB5022A £36.96	HB6022B £80.22	XHB4022A £36.44	XHB4522A £38.82	XHB5022A £45.32	XHB6022B £98.39
	HB4022B £29.72	HB4522B £31.67	HB5022B £36.96	HB6022C £80.22	XHB4022B £36.44	XHB4522B £38.82	XHB5022B £45.32	XHB6022C £98.38
STOP ENDS								
Description	Premier [Primed]				Premier Extra [Black]			
	100mm [4"]	115mm [4.5"]	125mm [5"]	150mm [6"]	100mm [4"]	115mm [4.5"]	125mm [5"]	150mm [6"]
External [for spigot]	HB4030 £10.05	HB4530 £12.35	HB5030 £13.05	HB6030 £22.10	XHB4030 £12.33	XHB4530 £15.15	XHB5030 £15.97	XHB6030 £27.09
Internal [for socket]	HB4031 £10.05	HB4531 £12.35	HB5031 £13.05	HB6031 £22.10	XHB4031 £12.33	XHB4531 £15.15	XHB5031 £15.97	XHB6031 £27.09
UNION CLIP								
Description	Premier [Primed]				Premier Extra [Black]			
	100mm [4"]	115mm [4.5"]	125mm [5"]	150mm [6"]	100mm [4"]	115mm [4.5"]	125mm [5"]	150mm [6"]
Union Clip	HB4035 £19.70	HB4535 £23.93	HB5035 £27.66	HB6035 £39.50	XHB4035 £24.16	XHB4535 £29.34	XHB5035 £33.91	XHB6035 £48.44
FASCIA BRACKET								
Description	Premier [Primed]				Premier Extra [Black]			
	100mm [4"]	115mm [4.5"]	125mm [5"]	150mm [6"]	100mm [4"]	115mm [4.5"]	125mm [5"]	150mm [6"]
Fascia Bracket	HB4040 £8.28	HB4540 £8.28	HB5040 £8.96	HB6040 £10.24	XHB4040 £10.15	XHB4540 £10.15	XHB5040 £10.97	XHB6040 £12.55
STEEL BRACKETS								
Description	Galvanised				Premier Extra [Black]			
	100mm [4"]	115mm [4.5"]	125mm [5"]	150mm [6"]	100mm [4"]	115mm [4.5"]	125mm [5"]	150mm [6"]
Top Fixing Rafter Bracket	HB4041 £7.44	HB4541 £7.89	HB5041 £8.37	HB6041 £9.71	XHB4041 £9.12	XHB4541 £9.68	XHB5041 £10.25	XHB6041 £11.93
Side Fixing Rafter Bracket	HB4042 £7.89	HB4542 £8.37	HB5042 £8.90	HB6042 £10.10	XHB4042 £9.68	XHB4542 £10.25	XHB5042 £10.94	XHB6042 £12.39
Rise & Fall Bracket	HB4043 £17.28	HB4543 £17.28	HB5043 £17.69	HB6043 £18.24	XHB4043 £21.63	XHB4543 £21.63	XHB5043 £22.11	XHB6043 £22.80

Please see page 20 for sundries.



Products can be supplied in any RAL or BS colour.
We can also colour match from customer supplied samples.
Price on application.

PLAIN DEEP HALF ROUND GUTTER				
	Premier [Primed]		Premier Extra [Black]	
Description	100mm x 75mm [4" x 3"]	125mm x 75mm [5" x 3"]	100mm x 75mm [4" x 3"]	125mm x 75mm [5" x 3"]
1829mm [6FT] with external joint	DH4301 £114.69	DH5301 £151.72	XDH4301 £142.59	XDH5301 £186.08

ANGLES				
	Premier [Primed]		Premier Extra [Black]	
Description	100mm x 75mm [4" x 3"]	125mm x 75mm [5" x 3"]	100mm x 75mm [4" x 3"]	125mm x 75mm [5" x 3"]
Square [90°] Left Hand	DH4310 £81.97	DH5310 £104.17	XDH4310 £106.58	XDH5310 £135.40
Square [90°] Right Hand	DH4311 £81.97	DH5311 £104.17	XDH4311 £106.58	XDH5311 £135.40
Obtuse [135°] Left Hand	DH4312 £81.97	DH5312 £104.17	XDH4312 £106.58	XDH5312 £135.40
Obtuse [135°] Right Hand	DH4313 £81.97	DH5313 £104.17	XDH4313 £106.58	XDH5313 £135.40

OUTLETS				
	Premier [Primed]		Premier Extra [Black]	
Description	100mm x 75mm [4" x 3"]	125mm x 75mm [5" x 3"]	100mm x 75mm [4" x 3"]	125mm x 75mm [5" x 3"]
A= 65mm [2.5"], B= 75mm [3"]				
Nozzle [Centre Drop]	DH4320A £81.97	DH5320A £104.17	XDH4320A £106.58	XDH5320A £135.40
	DH4320B £81.97	DH5320B £104.17	XDH4320B £106.58	XDH5320B £135.40
Dropend External	DH4321A £81.97	DH5321A £104.17	XDH4321A £106.58	XDH5321A £135.40
	DH4321B £81.97	DH5321B £104.17	XDH4321B £106.58	XDH5321B £135.40
Dropend Internal	DH4322A £81.97	DH5322A £104.17	XDH4322A £106.58	XDH5322A £135.40
	DH4322B £81.97	DH5322B £104.17	XDH4322B £106.58	XDH5322B £135.40

STOPENDS				
	Premier [Primed]		Premier Extra [Black]	
Description	100mm x 75mm [4" x 3"]	125mm x 75mm [5" x 3"]	100mm x 75mm [4" x 3"]	125mm x 75mm [5" x 3"]
External [for spigot]	DH4330 £29.72	DH5330 £34.86	XDH4330 £36.44	XDH5330 £42.75
Internal [for socket]	DH4331 £29.72	DH5331 £34.86	XDH4331 £36.44	XDH5331 £42.75

UNION CLIP				
	Premier [Primed]		Premier Extra [Black]	
Description	100mm x 75mm [4" x 3"]	125mm x 75mm [5" x 3"]	100mm x 75mm [4" x 3"]	125mm x 75mm [5" x 3"]
Union Clip	DH4335 £32.23	DH5335 £34.86	XDH4335 £39.51	XDH5335 £42.75

FASCIA BRACKET				
	Premier [Primed]		Premier Extra [Black]	
Description	100mm x 75mm [4" x 3"]	125mm x 75mm [5" x 3"]	100mm x 75mm [4" x 3"]	125mm x 75mm [5" x 3"]
Fascia Bracket	DH4340 £25.36	DH5340 £29.77	XDH4340 £31.11	XDH5340 £36.51

STEEL BRACKETS				
	Galvanised		Premier Extra [Black]	
Description	100mm x 75mm [4" x 3"]	125mm x 75mm [5" x 3"]	100mm x 75mm [4" x 3"]	125mm x 75mm [5" x 3"]
Top Fixing Rafter Bracket	DH4341 £17.93	DH5341 £18.24	XDH4341 £21.99	XDH5341 £22.34
Side Fixing Rafter Bracket	DH4342 £19.33	DH5342 £19.69	XDH4342 £23.69	XDH5342 £24.14
Rise & Fall Bracket	DH4343 £22.92	DH5343 £23.37		

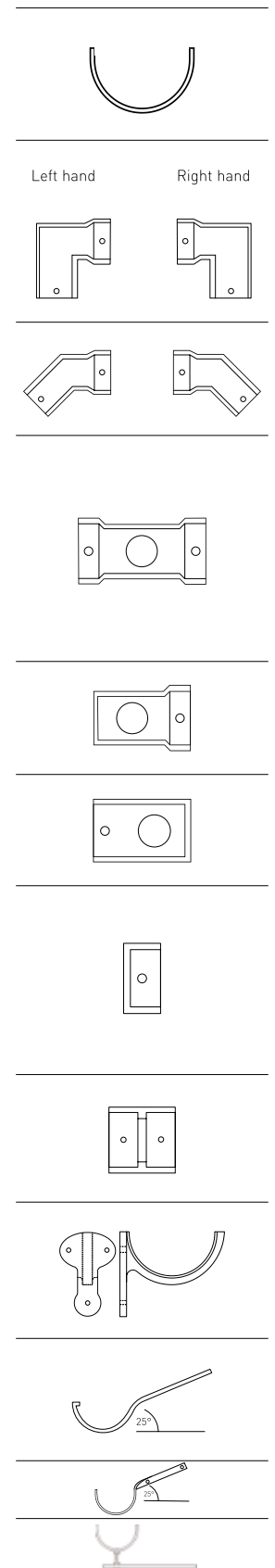

Please see page 20 for sundries.



Products can be supplied in any RAL or BS colour.
 We can also colour match from customer supplied samples.
 Price on application.

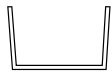

DOUBLE SPIGOT BOX GUTTER		
	Premier [Primed]	Premier Extra [Black]
Description	100mm x 75mm [4" x 3"]	100mm x 75mm [4" x 3"]
1829mm [6FT] without joint	B4301 £211.69	XB4301 £259.65



ANGLES		
	Premier [Primed]	Premier Extra [Black]
Description	100mm x 75mm [4" x 3"]	100mm x 75mm [4" x 3"]
Square [90°]	B4310 £56.99	XB4310 £74.11
Obtuse [135°]	B4311 £56.99	XB4311 £74.11



OUTLETS		
	Premier [Primed]	Premier Extra [Black]
Description	100mm x 75mm [4" x 3"]	100mm x 75mm [4" x 3"]
A= 65mm [2.5"], B= 75mm [3"]		
Nozzle [Centre Drop]	B4320A £56.99	XB4320A £74.11
	B4320B £56.99	XB4320B £74.11



STOPEND		
	Premier [Primed]	Premier Extra [Black]
Description	100mm x 75mm [4" x 3"]	100mm x 75mm [4" x 3"]
Stopend	B4330 £16.54	XB4330 £20.27



UNION CLIP		
	Premier [Primed]	Premier Extra [Black]
Description	100mm x 75mm [4" x 3"]	100mm x 75mm [4" x 3"]
Union Clip	B4335 £21.45	XB4335 £26.31



FASCIA BRACKET		
	Premier [Primed]	Premier Extra [Black]
Description	100mm x 75mm [4" x 3"]	100mm x 75mm [4" x 3"]
Fascia Bracket	B4340 £16.84	XB4340 £20.63

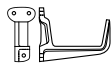

STEEL BRACKETS		
	Galvanised	Premier Extra [Black]
Description	100mm x 75mm [4" x 3"]	100mm x 75mm [4" x 3"]
Top Fixing Rafter Bracket	B4341 £25.25	XB4341 £30.97
Side Fixing Rafter Bracket	B4342 £27.81	XB4342 £34.10
Rise & Fall Bracket	B4343 £33.65	



Union Clips are required to join gutters, angles and outlets.
Please see page 20 for sundries.



Products can be supplied in any RAL or BS colour.
We can also colour match from customer supplied samples.
Price on application.

OG GUTTER						
	Premier (Primed)			Premier Extra (Black)		
Description	100mm [4"]	115mm [4.5"]	125mm [5"]	100mm [4"]	115mm [4.5"]	125mm [5"]
1829mm [6FT] with left hand external joint	OG4001 £79.59	OG4501 £87.60	OG5001 £91.84	XOG4001 £98.36	XOG4501 £108.27	XOG5001 £113.56
ANGLES						
	Premier (Primed)			Premier Extra (Black)		
Description	100mm [4"]	115mm [4.5"]	125mm [5"]	100mm [4"]	115mm [4.5"]	125mm [5"]
Square [90°] External	OG4010 £31.04	OG4510 £33.67	OG5010 £36.78	XOG4010 £38.07	XOG4510 £41.33	XOG5010 £45.11
Square [90°] Internal	OG4011 £31.04	OG4511 £33.67	OG5011 £36.78	XOG4011 £38.07	XOG4511 £41.33	XOG5011 £45.11
Obtuse [135°] External	OG4012 £31.04	OG4512 £33.67	OG5012 £36.78	XOG4012 £38.07	XOG4512 £41.33	XOG5012 £45.11
Obtuse [135°] Internal	OG4013 £31.04	OG4513 £33.67	OG5013 £36.78	XOG4013 £38.07	XOG4513 £41.33	XOG5013 £45.11
OUTLETS						
	Premier (Primed)			Premier Extra (Black)		
Description	100mm [4"]	115mm [4.5"]	125mm [5"]	100mm [4"]	115mm [4.5"]	125mm [5"]
A= 65mm [2.5"], B= 75mm [3"]						
Nozzle [Centre Drop]	OG4020A £31.04	OG4520A £33.67	OG5020A £36.78	XOG4020A £38.07	XOG4520A £41.33	XOG5020A £45.11
	OG4020B £31.04	OG4520B £33.67	OG5020B £36.78	XOG4020B £38.07	XOG4520B £41.33	XOG5020B £45.11
Dropend External	OG4021A £31.04	OG4521A £33.67	OG5021A £36.78	XOG4021A £38.07	XOG4521A £41.33	XOG5021A £45.11
	OG4021B £31.04	OG4521B £33.67	OG5021B £36.78	XOG4021B £38.07	XOG4521B £41.33	XOG5021B £45.11
Dropend Internal	OG4022A £31.04	OG4522A £33.67	OG5022A £36.78	XOG4022A £38.07	XOG4522A £41.33	XOG5022A £45.11
	OG4022B £31.04	OG4522B £33.67	OG5022B £36.78	XOG4022B £38.07	XOG4522B £41.33	XOG5022B £45.11
STOPENDS						
	Premier (Primed)			Premier Extra (Black)		
Description	100mm [4"]	115mm [4.5"]	125mm [5"]	100mm [4"]	115mm [4.5"]	125mm [5"]
External [for spigot]	OG4030 £9.04	OG4530 £11.47	OG5030 £12.10	XOG4030 £11.07	XOG4530 £14.05	XOG5030 £14.81
Internal [for socket]	OG4031 £9.04	OG4531 £11.47	OG5031 £12.10	XOG4031 £11.07	XOG4531 £14.05	XOG5031 £14.81
UNION CLIP						
	Premier (Primed)			Premier Extra (Black)		
Description	100mm [4"]	115mm [4.5"]	125mm [5"]	100mm [4"]	115mm [4.5"]	125mm [5"]
Union Clip	OG4035 £19.14	OG4535 £19.70	OG5035 £24.74	XOG4035 £23.48	XOG4535 £24.16	XOG5035 £30.34
FASCIA BRACKET						
	Premier (Primed)			Premier Extra (Black)		
Description	100mm [4"]	115mm [4.5"]	125mm [5"]	100mm [4"]	115mm [4.5"]	125mm [5"]
Fascia Bracket	OG4040 £8.48	OG4540 £8.96	OG5040 £10.10	XOG4040 £10.40	XOG4540 £10.97	XOG5040 £12.39
STEEL BRACKETS						
	Galvanised			Premier Extra (Black)		
Description	100mm [4"]	115mm [4.5"]	125mm [5"]	100mm [4"]	115mm [4.5"]	125mm [5"]
Top Fixing Rafter Bracket	OG4041 £16.31	OG4541 £16.54	OG5041 £16.81	XOG4041 £20.01	XOG4541 £20.27	XOG5041 £20.62
Side Fixing Rafter Bracket	OG4042 £17.65	OG4542 £17.93	OG5042 £18.17	XOG4042 £21.69	XOG4542 £21.99	XOG5042 £22.28
Rise & Fall Bracket	OG4043 £20.92	OG4543 £21.31	OG5043 £21.61			



External Internal

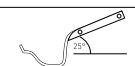
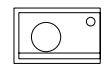
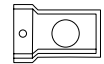
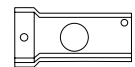

Please see page 20 for sundries.



Products can be supplied in any RAL or BS colour.
We can also colour match from customer supplied samples.
Price on application.



External

Internal

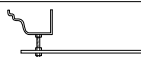
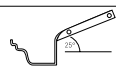
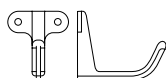
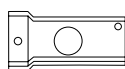
**NOTTS OG GUTTER**

Description	Premier (Primed) 115mm [4.5"]	Premier Extra (Black) 115mm [4.5"]
1829mm [6FT] with left hand external joint	N04501 £138.85	XN04501 £170.28

ANGLES

Description	Premier (Primed) 115mm [4.5"]	Premier Extra (Black) 115mm [4.5"]
Square [90°] External	N04510 £77.17	XN04510 £94.61
Square [90°] Internal	N04511 £77.17	XN04511 £94.61
Obtuse [135°] External	N04512 £77.17	XN04512 £94.61
Obtuse [135°] Internal	N04513 £77.17	XN04513 £94.61

OUTLETS

Description	Premier (Primed) 115mm [4.5"]	Premier Extra (Black) 115mm [4.5"]
A= 65mm [2.5"], B= 75mm [3"]		
Nozzle [Centre Drop]	N04520A £77.17	XN04520A £94.61
	N04520B £77.17	XN04520B £94.61
Dropend External	N04521A £77.17	XN04521A £94.61
	N04521B £77.17	XN04521B £94.61
Dropend Internal	N04522A £77.17	XN04522A £94.61
	N04522B £77.17	XN04522B £94.61

STOPENDS

Description	Premier (Primed) 115mm [4.5"]	Premier Extra (Black) 115mm [4.5"]
External [for spigot]	N04530 £27.50	XN04530 £33.73
Internal [for socket]	N04531 £27.50	XN04531 £33.73

UNION CLIP

Description	Premier (Primed) 115mm [4.5"]	Premier Extra (Black) 115mm [4.5"]
Union Clip	N04535 £32.23	XN04535 £39.51

FASCIA BRACKET

Description	Premier (Primed) 115mm [4.5"]	Premier Extra (Black) 115mm [4.5"]
Fascia Bracket	N04540 £25.70	XN04540 £32.21

STEEL BRACKETS

Description	Galvanised 115mm [4.5"]	Premier Extra (Black) 115mm [4.5"]
Top Fixing Rafter Bracket	N04541 £16.95	XN04541 £20.80
Side Fixing Rafter Bracket	N04542 £18.45	XN04542 £22.61
Rise & Fall Bracket	N04543 £22.57	

Please see page 20 for sundries.



Products can be supplied in any RAL or BS colour.
We can also colour match from customer supplied samples.
Price on application.

G46 MOULDED GUTTER				
	Premier [Primed]		Premier Extra [Black]	
Description	100mm x 75mm [4" x 3"]	125mm x 100mm [5" x 4"]	100mm x 75mm [4" x 3"]	125mm x 100mm [5" x 4"]
1829mm [6FT] with right hand internal joint	G4301 £136.74	G5401 £196.91	XG4301 £167.68	XG5401 £241.52
ANGLES				
	Premier [Primed]		Premier Extra [Black]	
Description	100mm x 75mm [4" x 3"]	125mm x 100mm [5" x 4"]	100mm x 75mm [4" x 3"]	125mm x 100mm [5" x 4"]
Square [90°] External	G4310 £75.53	G5410 £108.58	XG4310 £92.62	XG5410 £133.18
Square [90°] Internal	G4311 £75.53	G5411 £108.58	XG4311 £92.62	XG5411 £133.18
Obtuse [135°] External	G4312 £75.53	G5412 £108.58	XG4312 £92.62	XG5412 £133.18
Obtuse [135°] Internal	G4313 £75.53	G5413 £108.58	XG4313 £92.62	XG5413 £133.18
OUTLETS				
	Premier [Primed]		Premier Extra [Black]	
Description	100mm x 75mm [4" x 3"]	125mm x 100mm [5" x 4"]	100mm x 75mm [4" x 3"]	125mm x 100mm [5" x 4"]
A= 65mm [2.5"]. B= 75mm [3"]				
Nozzle [Centre Drop]	G4320A £75.53	G5420A £108.58	XG4320A £92.62	XG5420A £133.18
	G4320B £75.53	G5420B £108.58	XG4320B £92.62	XG5420B £133.18
Dropend External	G4321A £75.53	G5421A £108.58	XG4321A £92.62	XG5421A £133.18
	G4321B £75.53	G5421B £108.58	XG4321B £92.62	XG5421B £133.18
Dropend Internal	G4322A £75.53	G5422A £108.58	XG4322A £92.62	XG5422A £133.18
	G4322B £75.53	G5422B £108.58	XG4322B £92.62	XG5422B £133.18
STOPENDS				
	Premier [Primed]		Premier Extra [Black]	
Description	100mm x 75mm [4" x 3"]	125mm x 100mm [5" x 4"]	100mm x 75mm [4" x 3"]	125mm x 100mm [5" x 4"]
External [right hand]	G4330 £28.82	G5430 £35.47	XG4330 £35.34	XG5430 £43.64
Internal [left hand]	G4331 £28.82	G5431 £35.47	XG4331 £35.34	XG5431 £43.64
UNION CLIP				
	Premier [Primed]		Premier Extra [Black]	
Description	100mm x 75mm [4" x 3"]	125mm x 100mm [5" x 4"]	100mm x 75mm [4" x 3"]	125mm x 100mm [5" x 4"]
Union Clip	G4335 £31.63	G5435 £37.58	XG4335 £38.80	XG5435 £46.06
FASCIA BRACKET				
	Premier [Primed]		Premier Extra [Black]	
Description	100mm x 75mm [4" x 3"]	125mm x 100mm [5" x 4"]	100mm x 75mm [4" x 3"]	125mm x 100mm [5" x 4"]
Fascia Bracket	G4340 £12.29	G5440 £14.73	XG4340 £15.08	XG5440 £18.07
STEEL BRACKETS				
	Galvanised		Premier Extra [Black]	
Description	100mm x 75mm [4" x 3"]	125mm x 100mm [5" x 4"]	100mm x 75mm [4" x 3"]	125mm x 100mm [5" x 4"]
Top Fixing Rafter Bracket	G4341 £19.44	G5441 £19.84	XG4341 £23.83	XG5441 £24.36
Side Fixing Rafter Bracket	G4342 £20.99	G5442 £21.45	XG4342 £25.74	XG5442 £26.31
Rise & Fall Bracket	G4343 £26.32	G5443 £26.73		

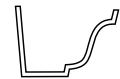

External Internal

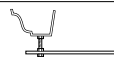
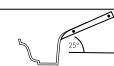
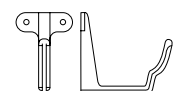
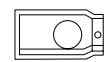
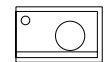
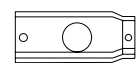
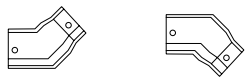

Please see page 20 for sundries.



Products can be supplied in any RAL or BS colour.
We can also colour match from customer supplied samples.
Price on application.



External

Internal

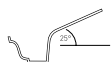
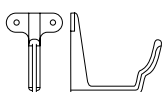
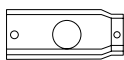

H16 MOULDED GUTTER

Description	Premier (Primed)		Premier Extra (Black)	
	125mm x 100mm [5" x 4"]	150mm x 100mm [6" x 4"]	125mm x 100mm [5" x 4"]	150mm x 100mm [6" x 4"]
1829mm [6FT] with right hand internal joint	H165401 £280.50	H166401 £296.09	XH165401 £336.59	XH166401 £355.32

ANGLES

Description	Premier (Primed)		Premier Extra (Black)	
	125mm x 100mm [5" x 4"]	150mm x 100mm [6" x 4"]	125mm x 100mm [5" x 4"]	150mm x 100mm [6" x 4"]
Square [90°] External	H165410 £140.27	H166410 £148.04	XH165410 £168.34	XH166410 £177.65
Square [90°] Internal	H165411 £140.27	H166411 £148.04	XH165411 £168.34	XH166411 £177.65
Obtuse [135°] External	H165412 £140.27	H166412 £148.04	XH165412 £168.34	XH166412 £177.65
Obtuse [135°] Internal	H165413 £140.27	H166413 £148.04	XH165413 £168.34	XH166413 £177.65

OUTLETS

Description	Premier (Primed)		Premier Extra (Black)	
	125mm x 100mm [5" x 4"]	150mm x 100mm [6" x 4"]	125mm x 100mm [5" x 4"]	150mm x 100mm [6" x 4"]
A= 65mm [2.5"], B= 75mm [3"]				
Nozzle [Centre Drop]	H165420A £140.27	H166420A £148.04	XH165420A £168.34	XH166420A £177.65
	H165420B £140.27	H166420B £148.04	XH165420B £168.34	XH166420B £177.65
Dropend External	H165421A £140.27	H166421A £148.04	XH165421A £168.34	XH166421A £177.65
	H165421B £140.27	H166421B £148.04	XH165421B £168.34	XH166421B £177.65
Dropend Internal	H165422A £140.27	H166422A £148.04	XH165422A £168.34	XH166422A £177.65
	H165422B £140.27	H166422B £148.04	XH165422B £168.34	XH166422B £177.65

STOPENDS

Description	Premier (Primed)		Premier Extra (Black)	
	125mm x 100mm [5" x 4"]	150mm x 100mm [6" x 4"]	125mm x 100mm [5" x 4"]	150mm x 100mm [6" x 4"]
External [right hand]]	H165430 £44.31	H166430 £46.77	XH165430 £53.16	XH166430 £56.12
Internal [left hand]	H165431 £44.31	H166431 £46.77	XH165431 £53.16	XH166431 £56.12

UNION CLIP

Description	Premier (Primed)		Premier Extra (Black)	
	125mm x 100mm [5" x 4"]	150mm x 100mm [6" x 4"]	125mm x 100mm [5" x 4"]	150mm x 100mm [6" x 4"]
Union Clip	H165435 £46.76	H166435 £49.32	XH165435 £56.11	XH166435 £59.21

FASCIA BRACKET

Description	Premier (Primed)		Premier Extra (Black)	
	125mm x 100mm [5" x 4"]	150mm x 100mm [6" x 4"]	125mm x 100mm [5" x 4"]	150mm x 100mm [6" x 4"]
Fascia Bracket	H165440 £16.35	H166440 £16.55	XH165440 £18.49	XH166440 £18.71

STEEL BRACKETS

Description	Galvanised		Premier Extra (Black)	
	125mm x 100mm [5" x 4"]	150mm x 100mm [6" x 4"]	125mm x 100mm [5" x 4"]	150mm x 100mm [6" x 4"]
Top Fixing Rafter Bracket	H165441 £28.98	H166441 £29.91	XH165441 £36.24	XH166441 £37.41
Side Fixing Rafter Bracket	H165442 £31.33	H166442 £32.23	XH165442 £39.19	XH166442 £40.30
Rise & Fall Bracket	H165443 £36.64	H166443 £38.93		

Please see page 20 for sundries.



Products can be supplied in any RAL or BS colour.
We can also colour match from customer supplied samples.
Price on application.



RAINWATER SUNDRIES & FIXINGS



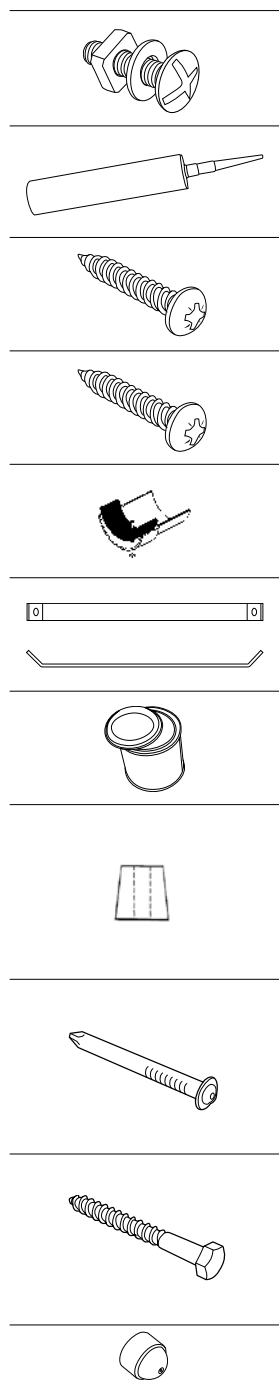

GUTTER BOLT, NUT & WASHER	
Description	
M6 x 25mm Bolt, Nut & Washer [Zinc Plated]	HR0001 £0.63
SILICONE SEALANT	
Description	
300ml Cartridge of Silicone Sealant	HR0002 £19.18
GUTTER FIXING SCREW	
Description	
16g x 30mm Mushroom Head Screw [Zinc Plated]	HR0003A* £1.12
BRACKET SCREW	
Description	
No. 10 x 1.25" Round Head Pozi Screw [Zinc Plated]	HR0004 £0.15
GUTTER JOINTING KIT	
Description	For use with Plain and Beaded Half Round only
10 Rubber Gaskets, Bolts, Nuts & Washers	HR0006 £31.74
UNDERSTAY	
Description	
Galvanised Understay for use with Rise and Fall Brackets	HR0007 £6.53
TOUCH UP PAINT	
Description	
250ml Black Gloss Finish	XP0007 £19.17
BOBBINS	
Description	
Wooden 30mm Projection	R0001 £2.63
Metal 13mm Projection	R0002 £7.35
PIPE NAILS	
Description	
75mm [3"] to Suit all Pipe Sizes	R0003 £0.89
100mm [4"] to Suit all Pipe Sizes	R0004 £0.98
COACH SCREWS	
Description	
M8 x 70mm Coach Screw [Zinc Plated]	R0005 £0.68
M8 x 100mm Coach Screw [Zinc Plated]	R0006 £0.89
M8 Black Plastic Coach Screw Caps	R0007 £0.68

Installation instructions available on request. *Possible alternative supplied.



RAINWATER HEADS EX STOCK



STANDARD RAINWATER HEADS

22

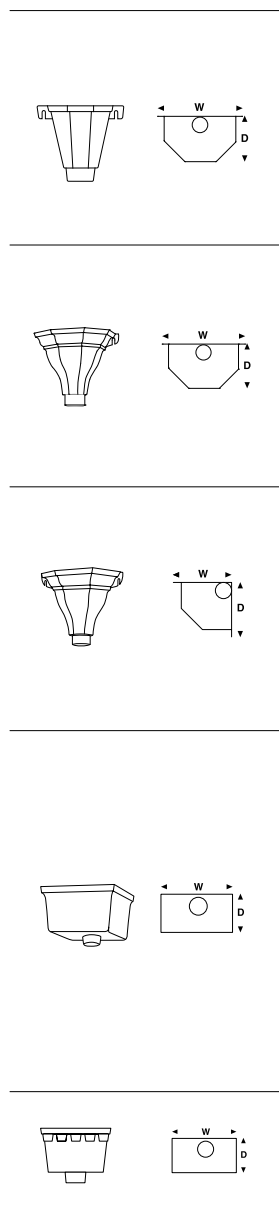

STANDARD HEADS			
Description	Width x Depth x Height	Premier [Primed]	Premier Extra [Black]
H0 Flat Back 65mm [2.5"]	210mm x 163mm x 195mm	RH025 £57.14	XRH025 £70.09
H0 Flat Back 75mm [3"]	210mm x 163mm x 195mm	RH03 £57.14	XRH03 £70.09
H0 Flat Back 100mm [4"]	253mm x 210mm x 210mm	RH04 £143.83	XRH04 £176.42
H1 65mm [2.5"] Flat Back	305mm x 197mm x 210mm	RH12.5 £168.35	XRH12.5 £182.63
H1 75mm [3"] Flat Back	305mm x 197mm x 210mm	RH13 £168.35	XRH13 £182.63
H1 100mm [4"] Flat Back	335mm x 230mm x 240mm	RH14 £236.85	XRH14 £256.96
H1 150mm [6"] Flat Back	367mm x 277mm x 220mm	RH16 £618.30	XRH16 £711.02
H1A 65mm [2.5"] Corner	210mm x 210mm x 222mm	RH1A2.5 £184.35	XRH1A2.5 £199.99
H1A 75mm [3"] Corner	210mm x 210mm x 222mm	RH1A3 £184.35	XRH1A3 £199.99
H1A 100mm [4"] Corner	240mm x 240mm x 240mm	RH1A4 £259.35	XRH1A4 £281.36
H1A 150mm [6"] Corner	277mm x 277mm x 220mm	RH1A6 £618.30	XRH1A6 £711.02
H460 Rectangular Plain 65mm [2.5"]	255mm x 178mm x 178mm	RH460102.5 £127.24	XRH460102.5 £165.39
H460 Rectangular Plain 75mm [3"]	255mm x 178mm x 178mm	RH460103 £127.24	XRH460103 £165.39
H460 Rectangular Plain 100mm [4"]	255mm x 178mm x 178mm	RH460104 £127.24	XRH460104 £165.39
H460 Rectangular Plain 65mm [2.5"]	305mm x 250mm x 200mm	RH460122.5 £248.71	XRH460122.5 £295.27
H460 Rectangular Plain 75mm [3"]	305mm x 250mm x 200mm	RH460123 £248.71	XRH460123 £295.27
H460 Rectangular Plain 100mm [4"]	305mm x 250mm x 200mm	RH460124 £248.71	XRH460124 £295.27
H460D Rectangular Castellated 65mm [2.5"]	255mm x 178mm x 178mm	RH46010D £127.24	XRH46010D £165.39
H460D Rectangular Castellated 75mm [3"]	255mm x 178mm x 178mm	RH460103D £127.24	XRH460103D £165.39

Other colours available on request – POA. Rainwater heads can be customised with dates or embellishments.



Products can be supplied in any RAL or BS colour.
We can also colour match from customer supplied samples.
Price on application.

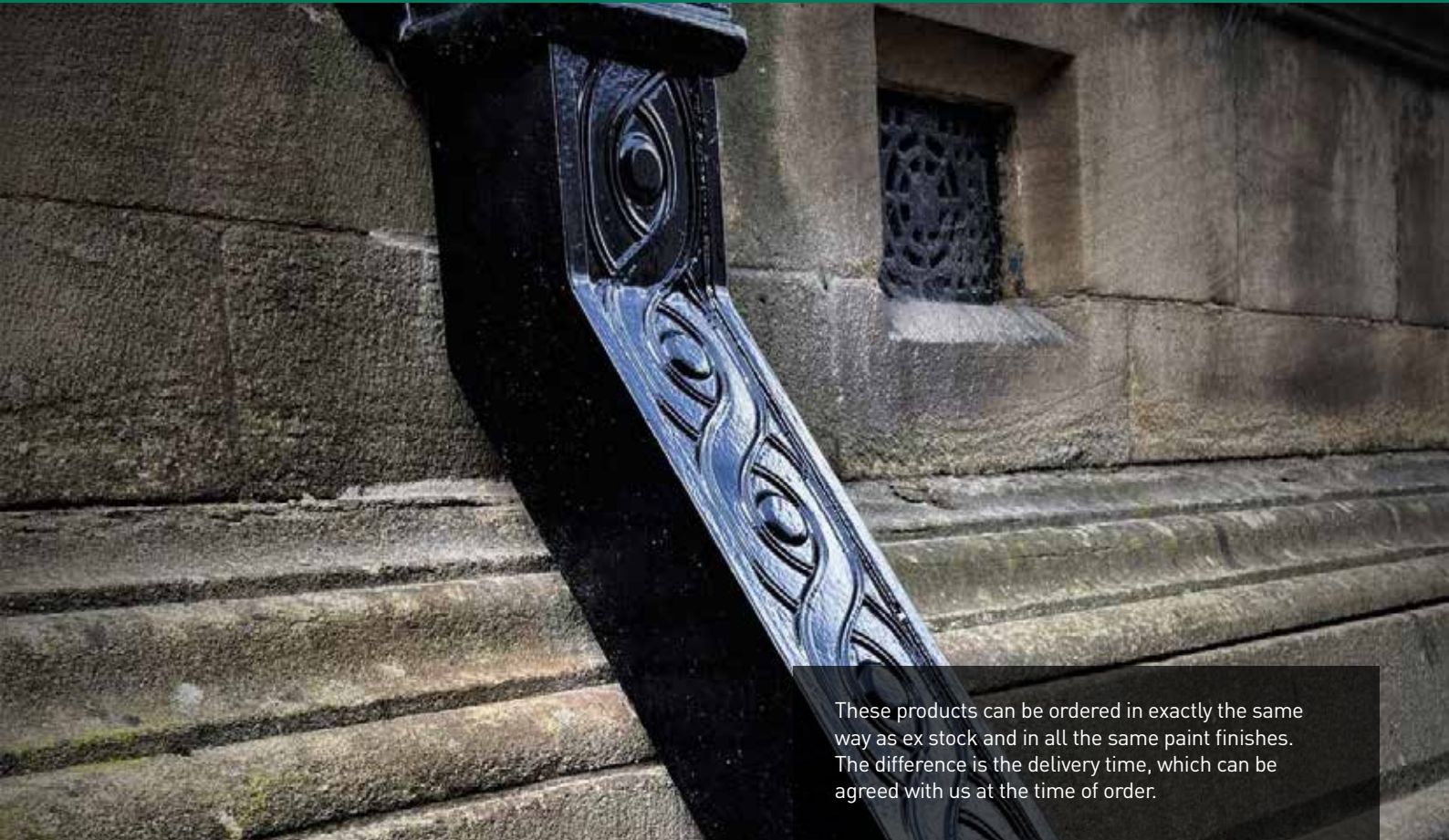

These products can be ordered in exactly the same way as ex stock and in all the same paint finishes. The difference is the delivery time, which can be agreed with us at the time of order.

RAINWATER PIPES MADE TO ORDER



SQUARE PIPES & FITTINGS	24-25
RECTANGULAR PIPES & FITTINGS	26-28
ORNAMENTAL EARBANDS	29



EARED PIPES						
Description	Premier (Primed)			Premier Extra (Black)		
	75mm x 75mm [3" x 3"]	100mm x 100mm [4" x 4"]	125mm x 125mm [5" x 5"]	75mm x 75mm [3" x 3"]	100mm x 100mm [4" x 4"]	125mm x 125mm [5" x 5"]
1829mm [6FT] Eared	SQ3301E £365.84	SQ4401E £431.74	SQ5501E £942.57	XSQ3301E £420.69	XSQ4401E £496.52	XSQ5501E £989.91
1219mm [4FT] Eared	SQ3304E £364.35	SQ4404E £411.82	SQ5504E £760.77	XSQ3304E £382.63	XSQ4404E £473.56	XSQ5504E £875.73
914mm [3FT] Eared	SQ3303E £297.95	SQ4403E £321.85	SQ5503E £677.81	XSQ3303E £312.89	XSQ4403E £370.10	XSQ5503E £779.48
610mm [2FT] Eared	SQ3302E £297.95	SQ4402E £321.85	SQ5502E £677.81	XSQ3302E £312.89	XSQ4402E £370.10	XSQ5502E £779.48



PLAIN PIPES						
Description	Premier (Primed)			Premier Extra (Black)		
	75mm x 75mm [3" x 3"]	100mm x 100mm [4" x 4"]	125mm x 125mm [5" x 5"]	75mm x 75mm [3" x 3"]	100mm x 100mm [4" x 4"]	125mm x 125mm [5" x 5"]
1829mm [6FT] Plain	SQ3301 £360.26	SQ4401 £424.45	SQ5501 £930.59	XSQ3301 £414.30	XSQ4401 £488.12	XSQ5501 £977.30
1219mm [4FT] Plain	SQ3304 £357.47	SQ4404 £403.03	SQ5504 £747.30	XSQ3304 £375.44	XSQ4404 £463.52	XSQ5504 £859.40
914mm [3FT] Plain	SQ3303 £288.47	SQ4403 £313.01	SQ5503 £663.80	XSQ3303 £302.98	XSQ4403 £359.95	XSQ5503 £763.32
610mm [2FT] Plain	SQ3302 £288.47	SQ4402 £313.01	SQ5502 £663.80	XSQ3302 £302.98	XSQ4402 £359.95	XSQ5502 £763.32



ACCESS PIPES						
Description	Premier (Primed)			Premier Extra (Black)		
	75mm x 75mm [3" x 3"]	100mm x 100mm [4" x 4"]	125mm x 125mm [5" x 5"]	75mm x 75mm [3" x 3"]	100mm x 100mm [4" x 4"]	125mm x 125mm [5" x 5"]
Eared	SQ3310E £386.69	SQ4410E £449.47	SQ5510E £831.98	XSQ3310E £419.52	XSQ4410E £487.61	XSQ5510E £873.78
Plain	SQ3310 £350.24	SQ4410 £410.80	SQ5510 £768.50	XSQ3310 £379.99	XSQ4410 £445.68	XSQ5510 £807.13



BENDS						
Description	Premier (Primed)			Premier Extra (Black)		
	75mm x 75mm [3" x 3"]	100mm x 100mm [4" x 4"]	125mm x 125mm [5" x 5"]	75mm x 75mm [3" x 3"]	100mm x 100mm [4" x 4"]	125mm x 125mm [5" x 5"]
92.5°	SQ3320 £161.35	SQ4420 £251.42	SQ5520 £376.87	XSQ3320 £169.46	XSQ4420 £289.16	XSQ5520 £433.37
112.5°	SQ3321 £161.35	SQ4421 £251.42	SQ5521 £376.87	XSQ3321 £169.46	XSQ4421 £289.16	XSQ5521 £433.37
135°	SQ3322 £161.35	SQ4422 £251.42	SQ5522 £376.87	XSQ3322 £169.46	XSQ4422 £289.16	XSQ5522 £433.37



BRANCHES						
Description	Premier (Primed)			Premier Extra (Black)		
	75mm x 75mm [3" x 3"]	100mm x 100mm [4" x 4"]	125mm x 125mm [5" x 5"]	75mm x 75mm [3" x 3"]	100mm x 100mm [4" x 4"]	125mm x 125mm [5" x 5"]
Single 92.5°	SQ3330 £358.95	SQ4430 £410.40	SQ5530 £576.02	XSQ3330 £377.00	XSQ4430 £471.95	XSQ5530 £662.46
Single 112.5°	SQ3331 £358.95	SQ4431 £410.40	SQ5531 £576.02	XSQ3331 £377.00	XSQ4431 £471.95	XSQ5531 £662.46
Single 135°	SQ3332 £358.95	SQ4432 £410.40	SQ5532 £576.02	XSQ3332 £377.00	XSQ4432 £471.95	XSQ5532 £662.46



LOOSE SOCKETS						
Description	Premier (Primed)			Premier Extra (Black)		
	75mm x 75mm [3" x 3"]	100mm x 100mm [4" x 4"]	125mm x 125mm [5" x 5"]	75mm x 75mm [3" x 3"]	100mm x 100mm [4" x 4"]	125mm x 125mm [5" x 5"]
With Spigot Eared	SQ3350E £120.49	SQ4450E £168.05	SQ5550E £235.24	XSQ3350E £126.56	XSQ4450E £193.22	XSQ5550E £270.58
With Spigot Plain	SQ3350S £99.39	SQ4450S £160.17	SQ5550S £222.23	XSQ3350S £104.39	XSQ4450S £184.17	XSQ5550S £255.54



SQUARE TO ROUND CONNECTOR						
Description	Premier (Primed)			Premier Extra (Black)		
	75mm x 75mm [3" x 3"]	100mm x 100mm [4" x 4"]	125mm x 125mm [5" x 5"]	75mm x 75mm [3" x 3"]	100mm x 100mm [4" x 4"]	125mm x 125mm [5" x 5"]
65mm Square to Round Connector	SQ3325A £230.98	SQ4425A £257.67	SQ5525A £398.35	XSQ3325A £242.58	XSQ4425A £296.31	XSQ5525A £458.13
75mm Square to Round Connector	SQ3325B £230.98	SQ4425B £257.67	SQ5525B £398.35	XSQ3325B £242.58	XSQ4425B £296.31	XSQ5525B £458.13
100mm Square to Round Connector		SQ4425C £257.67	SQ5525C £398.35		XSQ4425C £296.31	XSQ5525C £458.13

Ears can be fitted to any item on request – POA. Many items available from stock.

PLINTH OFFSETS 135°						
Description	Premier (Primed)			Premier Extra (Black)		
	75mm x 75mm [3" x 3"]	100mm x 100mm [4" x 4"]	125mm x 125mm [5" x 5"]	75mm x 75mm [3" x 3"]	100mm x 100mm [4" x 4"]	125mm x 125mm [5" x 5"]
75mm [3"] Projection	SQ3341P £222.62	SQ4441P £302.51	SQ5541P £492.43	XSQ3341P £233.80	XSQ4441P £347.91	XSQ5541P £566.28
115mm [4.5"] Projection	SQ3342P £239.46	SQ4442P £320.09	SQ5542P £539.55	XSQ3342P £251.51	XSQ4442P £368.14	XSQ5542P £620.41
150mm [6"] Projection	SQ3343P £239.46	SQ4443P £320.09	SQ5543P £539.55	XSQ3343P £251.51	XSQ4443P £368.14	XSQ5543P £620.41

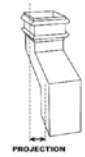

OFFSETS 112.5°						
Description	Premier (Primed)			Premier Extra (Black)		
	75mm x 75mm [3" x 3"]	100mm x 100mm [4" x 4"]	125mm x 125mm [5" x 5"]	75mm x 75mm [3" x 3"]	100mm x 100mm [4" x 4"]	125mm x 125mm [5" x 5"]
56mm [2.25"] Projection	SQ3340 £196.12	SQ4440 £254.85	SQ5540 £416.94	XSQ3340 £205.98	XSQ4440 £293.07	XSQ5540 £479.47
75mm [3"] Projection	SQ3341 £196.12	SQ4441 £254.85	SQ5541 £416.94	XSQ3341 £205.98	XSQ4441 £293.07	XSQ5541 £479.47
115mm [4.5"] Projection	SQ3342 £201.65	SQ4442 £284.38	SQ5542 £467.95	XSQ3342 £211.75	XSQ4442 £327.03	XSQ5542 £538.14
150mm [6"] Projection	SQ3343 £201.65	SQ4443 £284.38	SQ5543 £467.95	XSQ3343 £211.75	XSQ4443 £327.03	XSQ5543 £538.14
230mm [9"] Projection	SQ3344 £270.41	SQ4444 £345.82	SQ5544 £556.59	XSQ3344 £284.03	XSQ4444 £397.69	XSQ5544 £640.09
305mm [12"] Projection	SQ3345 £298.84	SQ4445 £432.78	SQ5545 £699.29	XSQ3345 £313.85	XSQ4445 £497.71	XSQ5545 £804.18
380mm [15"] Projection	SQ3346 £372.20	SQ4446 £509.30	SQ5546 £938.62	XSQ3346 £390.89	XSQ4446 £585.71	XSQ5546 £1,079.38
457mm [18"] Projection	SQ3347 £469.41	SQ4447 £687.07	SQ5547 £1,126.69	XSQ3347 £471.57	XSQ4447 £755.81	XSQ5547 £1,239.33
533mm [21"] Projection	SQ3348 £580.93	SQ4448 £875.69	SQ5548 £1,316.66	XSQ3348 £583.60	XSQ4448 £963.30	XSQ5548 £1,448.29
610mm [24"] Projection	SQ3349 £678.65	SQ4449 £1,005.77	SQ5549 £1,361.83	XSQ3349 £681.75	XSQ4449 £1,106.36	XSQ5549 £1,498.00

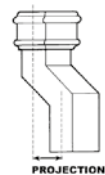

SHOES						
Description	Premier (Primed)			Premier Extra (Black)		
	75mm x 75mm [3" x 3"]	100mm x 100mm [4" x 4"]	125mm x 125mm [5" x 5"]	75mm x 75mm [3" x 3"]	100mm x 100mm [4" x 4"]	125mm x 125mm [5" x 5"]
Eared	SQ3351E £206.56	SQ4451E £253.81	SQ5551E £385.73	XSQ3351E £216.94	XSQ4451E £291.86	XSQ5551E £443.66
Plain	SQ3351 £200.64	SQ4451 £243.47	SQ5551 £378.53	XSQ3351 £210.76	XSQ4451 £279.98	XSQ5551 £435.36
Left Hand Eared	SQ3351SLE £260.20	SQ4451SLE £313.97	SQ5551SLE £431.38	XSQ3351SLE £273.24	XSQ4451SLE £361.09	XSQ5551SLE £496.11
Right Hand Eared	SQ3351SRE £260.20	SQ4451SRE £313.97	SQ5551SRE £431.38	XSQ3351SRE £273.24	XSQ4451SRE £361.09	XSQ5551SRE £496.11
Anti-Splash Eared	SQ3352E £288.21	SQ4452E £399.52	SQ5552E £602.91	XSQ3352E £302.71	XSQ4452E £459.43	XSQ5552E £693.34
Anti-Splash Plain	SQ3352 £266.57	SQ4452 £363.10	SQ5552 £570.85	XSQ3352 £279.99	XSQ4452 £417.62	XSQ5552 £656.44



HOLDERBAT						
Description	Premier (Primed)			Premier Extra (Black)		
	75mm x 75mm [3" x 3"]	100mm x 100mm [4" x 4"]	125mm x 125mm [5" x 5"]	75mm x 75mm [3" x 3"]	100mm x 100mm [4" x 4"]	125mm x 125mm [5" x 5"]
Build-in	SQ3360 £103.18	SQ4460 £205.98	SQ5560 £302.96	XSQ3360 £108.35	XSQ4460 £236.85	XSQ5560 £348.43



EARBANDS						
Description	Premier (Primed)			Premier Extra (Black)		
	75mm x 75mm [3" x 3"]	100mm x 100mm [4" x 4"]	125mm x 125mm [5" x 5"]	75mm x 75mm [3" x 3"]	100mm x 100mm [4" x 4"]	125mm x 125mm [5" x 5"]
Plain	SQ3365 £77.82	SQ4465 £95.61	SQ5565 £119.65	XSQ3365 £81.72	XSQ4465 £109.97	XSQ5565 £137.59



Ears can be fitted to any item on request – POA. Many items available from stock. For additional ornamental earbands see page 29.



Products can be supplied in any RAL or BS colour.
We can also colour match from customer supplied samples.
Price on application.



EARED PIPES								
Description	Premier [Primed]				Premier Extra [Black]			
	100 x 75mm [4" x 3"]	125 x 70mm [5" x 2.75"]	125 x 100mm [5" x 4"]	150 x 100mm [6" x 4"]	100 x 75mm [4" x 3"]	125 x 70mm [5" x 2.75"]	125 x 100mm [5" x 4"]	150 x 100mm [6" x 4"]
1829mm [6FT] Eared	RT4301E £391.10	RT5301E £538.91	RT5401E £467.54	RT6401E £656.77	XRT4301E £410.77	XRT5301E £565.96	XRT5401E £537.66	XRT6401E £659.97
1219mm [4FT] Eared	RT4304E £353.89	RT5304E £447.33	RT5404E £447.33	RT6404E £529.28	XRT4304E £371.65	XRT5304E £514.40	XRT5404E £514.40	XRT6404E £583.27
914mm [3FT] Eared	RT4303E £289.28	RT5303E £370.21	RT5403E £370.21	RT6403E £432.22	XRT4303E £303.77	XRT5303E £425.76	XRT5403E £425.76	XRT6403E £497.05
610mm [2FT] Eared	RT4302E £289.28	RT5302E £370.21	RT5402E £370.21	RT6402E £432.22	XRT4302E £303.77	XRT5302E £425.76	XRT5402E £425.76	XRT6402E £497.05



PLAIN PIPES								
Description	Premier [Primed]				Premier Extra [Black]			
	100 x 75mm [4" x 3"]	125 x 70mm [5" x 2.75"]	125 x 100mm [5" x 4"]	150 x 100mm [6" x 4"]	100 x 75mm [4" x 3"]	125 x 70mm [5" x 2.75"]	125 x 100mm [5" x 4"]	150 x 100mm [6" x 4"]
1829mm [6FT] Plain	RT4301 £384.28	RT5301 £533.05	RT5401 £462.47	RT6401 £647.36	XRT4301 £403.57	XRT5301 £559.82	XRT5401 £531.82	XRT6401 £651.56
1219mm [4FT] Plain	RT4304 £346.39	RT5304 £439.60	RT5404 £439.60	RT6404 £519.89	XRT4304 £363.80	XRT5304 £505.54	XRT5404 £505.54	XRT6404 £572.96
914mm [3FT] Plain	RT4303 £280.86	RT5303 £362.23	RT5403 £362.23	RT6403 £423.23	XRT4303 £294.99	XRT5303 £416.23	XRT5403 £416.55	XRT6403 £486.75
610mm [2FT] Plain	RT4302 £280.86	RT5302 £362.23	RT5402 £362.23	RT6402 £423.23	XRT4302 £294.99	XRT5302 £416.55	XRT5402 £416.55	XRT6402 £486.75



ACCESS PIPES								
Description	Premier [Primed]				Premier Extra [Black]			
	100 x 75mm [4" x 3"]	125 x 70mm [5" x 2.75"]	125 x 100mm [5" x 4"]	150 x 100mm [6" x 4"]	100 x 75mm [4" x 3"]	125 x 70mm [5" x 2.75"]	125 x 100mm [5" x 4"]	150 x 100mm [6" x 4"]
Eared	RT4310E £348.85	RT5310E £481.59	RT5410E £439.81	RT6410E £499.24	XRT4310E £401.13	XRT5310E £505.75	XRT5410E £505.75	XRT6410E £524.33
Plain	RT4310 £310.58	RT5310 £435.05	RT5410 £397.30	RT6410 £452.72	XRT4310 £357.17	XRT5310 £456.91	XRT5410 £456.91	XRT6410 £475.47



BENDS								
Description	Premier [Primed]				Premier Extra [Black]			
	100 x 75mm [4" x 3"]	125 x 70mm [5" x 2.75"]	125 x 100mm [5" x 4"]	150 x 100mm [6" x 4"]	100 x 75mm [4" x 3"]	125 x 70mm [5" x 2.75"]	125 x 100mm [5" x 4"]	150 x 100mm [6" x 4"]
Front 92.5°	RT4320 £159.42	RT5320 £276.55	RT5420 £276.55	RT6420 £326.60	XRT4320 £167.46	XRT5320 £318.07	XRT5420 £318.07	XRT6420 £375.59
Front 112.5°	RT4321 £159.42	RT5321 £276.55	RT5421 £276.55	RT6421 £326.60	XRT4321 £167.46	XRT5321 £318.07	XRT5421 £318.07	XRT6421 £375.59
Front 135°	RT4322 £159.42	RT5322 £276.55	RT5422 £276.55	RT6422 £326.60	XRT4322 £167.46	XRT5322 £318.07	XRT5422 £318.07	XRT6422 £375.59
Side 92.5°	RS4320 £186.61	RS5320 £298.63	RS5420 £298.63	RS6420 £346.14	XRS4320 £195.99	XRS5320 £343.41	XRS5420 £343.41	XRS6420 £398.05
Side 112.5°	RS4321 £186.61	RS5321 £298.63	RS5421 £298.63	RS6421 £346.14	XRS4321 £195.99	XRS5321 £343.41	XRS5421 £343.41	XRS6421 £398.05
Side 135°	RS4322 £186.61	RS5322 £298.63	RS5422 £298.63	RS6422 £346.14	XRS4322 £195.99	XRS5322 £343.41	XRS5422 £343.41	XRS6422 £398.05



BRANCHES								
Description	Premier [Primed]				Premier Extra [Black]			
	100 x 75mm [4" x 3"]	125 x 70mm [5" x 2.75"]	125 x 100mm [5" x 4"]	150 x 100mm [6" x 4"]	100 x 75mm [4" x 3"]	125 x 70mm [5" x 2.75"]	125 x 100mm [5" x 4"]	150 x 100mm [6" x 4"]
Single 92.5°	RT4330 £349.51	RT5330 £461.51	RT5430 £461.51	RT6430 £537.61	XRT4330 £367.06	XRT5330 £530.71	XRT5430 £530.71	XRT6430 £618.27
Single 112.5°	RT4331 £349.51	RT5331 £461.51	RT5431 £461.51	RT6431 £537.61	XRT4331 £367.06	XRT5331 £530.71	XRT5431 £530.71	XRT6431 £618.27
Single 135°	RT4332 £349.51	RT5332 £461.51	RT5432 £461.51	RT6432 £537.61	XRT4332 £367.06	XRT5332 £530.71	XRT5432 £530.71	XRT6432 £618.27



LOOSE SOCKETS								
Description	Premier [Primed]				Premier Extra [Black]			
	100 x 75mm [4" x 3"]	125 x 70mm [5" x 2.75"]	125 x 100mm [5" x 4"]	150 x 100mm [6" x 4"]	100 x 75mm [4" x 3"]	125 x 70mm [5" x 2.75"]	125 x 100mm [5" x 4"]	150 x 100mm [6" x 4"]
With Spigot Eared	RT4350SE £128.67	RT5350SE £174.09	RT5450SE £174.09	RT6450SE £196.04	XRT4350SE £135.18	XRT5350SE £200.17	XRT5450SE £200.17	XRT6450SE £225.49
With Spigot Plain	RT4350S £97.91	RT5350S £167.60	RT5450S £167.60	RT6450S £185.20	XRT4350S £102.84	XRT5350S £192.73	XRT5450S £192.73	XRT6450S £212.95

RECTANGULAR TO ROUND CONNECTOR

Description	Premier [Primed]				Premier Extra [Black]			
	100 x 75mm [4" x 3"]	125 x 70mm [5" x 2.75"]	125 x 100mm [5" x 4"]	150 x 100mm [6" x 4"]	100 x 75mm [4" x 3"]	125 x 70mm [5" x 2.75"]	125 x 100mm [5" x 4"]	150 x 100mm [6" x 4"]
65mm Rectangular to Round connector	RT4325A £209.58	RT5325A £281.77	RT5425A £281.77	RT6425A £318.70	XRT4325A £220.12	XRT5325A £324.05	XRT5425A £324.05	XRT6425A £366.49
75mm Rectangular to Round connector	RT4325B £209.58	RT5325B £281.77	RT5425B £281.77	RT6425B £318.70	XRT4325B £220.12	XRT5325B £324.05	XRT5425B £324.05	XRT6425B £366.49
100mm Rectangular to Round connector	RT4325C £209.58		RT5425C £281.77	RT6425C £318.70	XRT4325C £220.12		XRT5425C £324.05	XRT6425C £366.49



PLINTH OFFSETS 135°

Description	Premier [Primed]				Premier Extra [Black]			
	100 x 75mm [4" x 3"]	125 x 70mm [5" x 2.75"]	125 x 100mm [5" x 4"]	150 x 100mm [6" x 4"]	100 x 75mm [4" x 3"]	125 x 70mm [5" x 2.75"]	125 x 100mm [5" x 4"]	150 x 100mm [6" x 4"]
75mm [3"] Projection	RT4341P £212.81	RT5341P £345.79	RT5441P £345.79	RT6441P £456.68	XRT4341P £223.49	XRT5341P £397.66	XRT5441P £397.66	XRT6441P £525.17
115mm [4.5"] Projection	RT4342P £230.92	RT5342P £398.99	RT5442P £398.99	RT6442P £503.57	XRT4342P £242.48	XRT5342P £458.84	XRT5442P £458.84	XRT6442P £579.08
150mm [6"] Projection	RT4343P £230.92	RT5343P £398.99	RT5443P £398.99	RT6443P £503.57	XRT4343P £242.48	XRT5343P £458.84	XRT5443P £458.84	XRT6443P £579.08

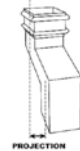

FRONT OFFSETS 112.5°

Description	Premier [Primed]				Premier Extra [Black]			
	100 x 75mm [4" x 3"]	125 x 70mm [5" x 2.75"]	125 x 100mm [5" x 4"]	150 x 100mm [6" x 4"]	100 x 75mm [4" x 3"]	125 x 70mm [5" x 2.75"]	125 x 100mm [5" x 4"]	150 x 100mm [6" x 4"]
56mm [2.25"] Projection	RT4340 £185.91	RT5340 £296.76	RT5440 £296.76	RT6440 £384.87	XRT4340 £195.24	XRT5340 £341.27	XRT5440 £341.27	XRT6440 £442.60
75mm [3"] Projection	RT4341 £185.91	RT5341 £296.76	RT5441 £296.76	RT6441 £384.87	XRT4341 £195.24	XRT5341 £341.27	XRT5441 £341.27	XRT6441 £442.60
115mm [4.5"] Projection	RT4342 £205.86	RT5342 £337.57	RT5442 £337.57	RT6442 £431.95	XRT4342 £216.19	XRT5342 £388.24	XRT5442 £388.24	XRT6442 £496.74
150mm [6"] Projection	RT4343 £205.86	RT5343 £337.57	RT5443 £337.57	RT6443 £431.95	XRT4343 £216.19	XRT5343 £388.24	XRT5443 £388.24	XRT6443 £496.74
230mm [9"] Projection	RT4344 £252.66	RT5344 £405.89	RT5444 £405.90	RT6444 £513.96	XRT4344 £265.33	XRT5344 £466.83	XRT5444 £466.83	XRT6444 £591.07
305mm [12"] Projection	RT4345 £307.76	RT5345 £525.99	RT5445 £525.99	RT6445 £647.50	XRT4345 £323.23	XRT5345 £604.85	XRT5445 £604.85	XRT6445 £744.61
380mm [15"] Projection	RT4346 £436.25	RT5346 £762.71	RT5446 £762.71	RT6446 £921.20	XRT4346 £458.15	XRT5346 £843.40	XRT5446 £843.40	XRT6446 £1,059.40
457mm [18"] Projection	RT4347 £533.85	RT5347 £870.99	RT5447 £870.99	RT6447 £1,049.84	XRT4347 £536.28	XRT5347 £958.09	XRT5447 £958.09	XRT6447 £1,154.81
533mm [21"] Projection	RT4348 £662.17	RT5348 £1,058.58	RT5448 £1,058.58	RT6448 £1,266.04	XRT4348 £665.19	XRT5348 £1,164.43	XRT5448 £1,164.43	XRT6448 £1,392.59
610mm [24"] Projection	RT4349 £662.17	RT5349 £1,058.58	RT5449 £1,058.58	RT6449 £1,266.04	XRT4349 £665.19	XRT5349 £1,164.43	XRT5449 £1,164.43	XRT6449 £1,392.59

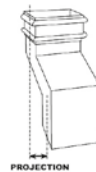

SIDE OFFSETS 112.5°

Description	Premier [Primed]				Premier Extra [Black]			
	100 x 75mm [4" x 3"]	125 x 70mm [5" x 2.75"]	125 x 100mm [5" x 4"]	150 x 100mm [6" x 4"]	100 x 75mm [4" x 3"]	125 x 70mm [5" x 2.75"]	125 x 100mm [5" x 4"]	150 x 100mm [6" x 4"]
56mm [2.25"] Projection	RS4340 £224.65	RS5340 £341.08	RS5440 £341.08	RS6440 £421.31	XRS4340 £235.92	XRS5340 £392.25	XRS5440 £392.25	XRS6440 £484.50
75mm [3"] Projection	RS4341 £224.65	RS5341 £341.08	RS5441 £341.08	RS6441 £421.31	XRS4341 £235.92	XRS5341 £392.25	XRS5441 £392.25	XRS6441 £484.50
115mm [4.5"] Projection	RS4342 £257.38	RS5342 £387.94	RS5442 £387.94	RS6442 £472.51	XRS4342 £270.31	XRS5342 £446.17	XRS5442 £446.17	XRS6442 £543.36
150mm [6"] Projection	RS4343 £257.38	RS5343 £387.94	RS5443 £387.94	RS6443 £472.51	XRS4343 £270.31	XRS5343 £446.17	XRS5443 £446.17	XRS6443 £543.36
230mm [9"] Projection	RS4344 £325.02	RS5344 £527.07	RS5444 £527.07	RS6444 £588.88	XRS4344 £341.37	XRS5344 £606.14	XRS5444 £606.14	XRS6444 £677.22
305mm [12"] Projection	RS4345 £346.00	RS5345 £606.15	RS5445 £606.15	RS6445 £732.22	XRS4345 £363.37	XRS5345 £697.11	XRS5445 £697.11	XRS6445 £842.05
380mm [15"] Projection	RS4346 £513.30	RS5346 £841.05	RS5446 £841.05	RS6446 £1,033.91	XRS4346 £515.68	XRS5346 £925.18	XRS5446 £925.18	XRS6446 £1,137.30
457mm [18"] Projection	RS4347 £642.01	RS5347 £984.60	RS5447 £984.60	RS6447 £1,259.03	XRS4347 £644.93	XRS5347 £1,083.04	XRS5447 £1,083.04	XRS6447 £1,384.96
533mm [21"] Projection	RS4348 £801.48	RS5348 £1,154.81	RS5448 £1,154.81	RS6448 £1,391.63	XRS4348 £805.15	XRS5348 £1,270.30	XRS5448 £1,270.30	XRS6448 £1,530.74
610mm [24"] Projection	RS4349 £801.48	RS5349 £1,154.81	RS5449 £1,154.81	RS6449 £1,391.63	XRS4349 £805.15	XRS5349 £1,270.30	XRS5449 £1,270.30	XRS6449 £1,530.74

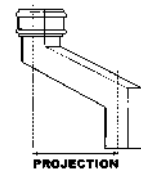



To fit socket



To fit socket



SHOES

Description	Premier [Primed]				Premier Extra [Black]			
	100 x 75mm [4" x 3"]	125 x 70mm [5" x 2.75"]	125 x 100mm [5" x 4"]	150 x 100mm [6" x 4"]	100 x 75mm [4" x 3"]	125 x 70mm [5" x 2.75"]	125 x 100mm [5" x 4"]	150 x 100mm [6" x 4"]
Front Eared	RT4351E £214.98	RT5351E £277.12	RT5451E £277.12	RT6451E £321.40	XRT4351E £225.77	XRT5351E £300.66	XRT5451E £300.66	XRT6451E £369.67
Front Plain	RT4351 £195.41	RT5351 £271.30	RT5451 £271.30	RT6451 £315.47	XRT4351 £205.28	XRT5351 £312.01	XRT5451 £312.01	XRT6451 £362.79
Left Hand Eared	RS4351LE £259.66	RS5351LE £346.46	RS5451LE £346.46	RS6451LE £402.74	XRS4351LE £272.71	XRS5351LE £375.84	XRS5451LE £375.84	XRS6451LE £463.13
Right Hand Eared	RS4351RE £259.66	RS5351RE £346.46	RS5451RE £346.46	RS6451RE £402.74	XRS4351RE £272.71	XRS5351RE £375.84	XRS5451RE £375.84	XRS6451RE £463.13
Left Hand Plain	RS4351L £238.31	RS5351L £311.21	RS5451L £311.21	RS6451L £393.35	XRS4351L £238.31	XRS5351L £311.21	XRS5451L £357.90	XRS6451L £393.35
Right Hand Plain	RS4351R £238.31	RS5351R £311.21	RS5451R £311.21	RS6451R £393.35	XRS4351R £238.31	XRS5351R £311.21	XRS5451R £357.90	XRS6451R £393.35
Anti-Splash Eared	RT4352E £240.51	RT5352E £428.59	RT5452E £428.59	RT6452E £482.31	XRT4352E £249.93	XRT5352E £492.90	XRT5452E £492.90	XRT6452E £554.68
Anti-Splash Plain	RT4352 £222.15	RT5352 £393.36	RT5452 £393.36	RT6452 £456.68	XRT4352 £233.30	XRT5352 £452.38	XRT5452 £452.38	XRT6452 £525.15

HOLDERBAT

Description	Premier [Primed]				Premier Extra [Black]			
	100 x 75mm [4" x 3"]	125 x 70mm [5" x 2.75"]	125 x 100mm [5" x 4"]	150 x 100mm [6" x 4"]	100 x 75mm [4" x 3"]	125 x 70mm [5" x 2.75"]	125 x 100mm [5" x 4"]	150 x 100mm [6" x 4"]
Build-in	RT4360 £103.18	RT5360 £214.66	RT5460 £214.66	RT6460 £282.76	XRT4360 £108.35	XRT5360 £246.84	XRT5460 £246.84	XRT6460 £325.20

EARBANDS

Description	Premier [Primed]				Premier Extra [Black]			
	100 x 75mm [4" x 3"]	125 x 70mm [5" x 2.75"]	125 x 100mm [5" x 4"]	150 x 100mm [6" x 4"]	100 x 75mm [4" x 3"]	125 x 70mm [5" x 2.75"]	125 x 100mm [5" x 4"]	150 x 100mm [6" x 4"]
Plain	RT4365 £81.88	RT5365 £124.82	RT5465 £124.82	RT6465 £138.03	XRT4365 £85.99	XRT5365 £143.57	XRT5465 £143.57	XRT6465 £158.72

Ears can be fitted to any item on request – POA. Many items available from stock.



Products can be supplied in any RAL or BS colour.
We can also colour match from customer supplied samples.
Price on application.

ROUND EARBANDS								
Description	Premier [Primed]				Premier Extra [Black]			
	65mm [2.5"]	75mm [3"]	100mm [4"]	150mm [6"]	65mm [2.5"]	75mm [3"]	100mm [4"]	150mm [6"]
Ornamental Type A	R25650A £108.84	R30650A £108.84	R40650A £128.23	R60650A £145.54	XR25650A £136.06	XR30650A £136.06	XR40650A £160.30	XR60650A £181.93
Ornamental Type B	R25650B £108.84	R30650B £108.84	R40650B £128.23	R60650B £145.54	XR25650B £136.06	XR30650B £136.06	XR40650B £160.30	XR60650B £181.93
Ornamental Type C	R25650C £108.84	R30650C £108.84	R40650C £128.23	R60650C £145.54	XR25650C £136.06	XR30650C £136.06	XR40650C £160.30	XR60650C £181.93
Ornamental Type D	R25650D £108.84	R30650D £108.84	R40650D £128.23	R60650D £145.54	XR25650D £136.06	XR30650D £136.06	XR40650D £160.30	XR60650D £181.93
Ornamental Type E	R25650E £108.84	R30650E £108.84	R40650E £128.23	R60650E £145.54	XR25650E £136.06	XR30650E £136.06	XR40650E £160.30	XR60650E £181.93
Ornamental Type F	R25650F £108.84	R30650F £108.84	R40650F £128.23	R60650F £145.54	XR25650F £136.06	XR30650F £136.06	XR40650F £160.30	XR60650F £181.93
Ornamental Type G	R25650G £108.84	R30650G £108.84	R40650G £128.23	R60650G £145.54	XR25650G £136.06	XR30650G £136.06	XR40650G £160.30	XR60650G £181.93
Ornamental Type J	R25650J £108.84	R30650J £108.84	R40650J £128.23	R60650J £145.54	XR25650J £136.06	XR30650J £136.06	XR40650J £160.30	XR60650J £181.93
Ornamental Type K	R25650K £108.84	R30650K £108.84	R40650K £128.23	R60650K £145.54	XR25650K £136.06	XR30650K £136.06	XR40650K £160.30	XR60650K £181.93

SQUARE EARBANDS						
Description	Premier [Primed]			Premier Extra [Black]		
	"75mm x 75mm [3" x 3"]"	"100mm x 100mm [4" x 4"]"	"125mm x 125mm [5" x 5"]"	"75mm x 75mm [3" x 3"]"	"100mm x 100mm [4" x 4"]"	"125mm x 125mm [5" x 5"]"
Ornamental Type A	SQ33650A £89.52	SQ44650A £125.60	SQ55650A £168.98	XSQ33650A £104.38	XSQ44650A £144.40	XSQ55650A £177.46
Ornamental Type B	SQ33650B £89.52	SQ44650B £125.60	SQ55650B £168.98	XSQ33650B £104.38	XSQ44650B £144.40	XSQ55650B £177.46
Ornamental Type C	SQ33650C £89.52	SQ44650C £125.60	SQ55650C £168.98	XSQ33650C £104.38	XSQ44650C £144.40	XSQ55650C £177.46
Ornamental Type D	SQ33650D £89.52	SQ44650D £125.60	SQ55650D £168.98	XSQ33650D £104.38	XSQ44650D £144.40	XSQ55650D £177.46
Ornamental Type E	SQ33650E £89.52	SQ44650E £125.60	SQ55650E £168.98	XSQ33650E £104.38	XSQ44650E £144.40	XSQ55650E £177.46
Ornamental Type F	SQ33650F £89.52	SQ44650F £125.60	SQ55650F £168.98	XSQ33650F £104.38	XSQ44650F £144.40	XSQ55650F £177.46
Ornamental Type G	SQ33650G £89.52	SQ44650G £125.60	SQ55650G £168.98	XSQ33650G £104.38	XSQ44650G £144.40	XSQ55650G £177.46
Ornamental Type J	SQ33650J £89.52	SQ44650J £125.60	SQ55650J £168.98	XSQ33650J £104.38	XSQ44650J £144.40	XSQ55650J £177.46
Ornamental Type K	SQ33650K £89.52	SQ44650K £125.60	SQ55650K £168.98	XSQ33650K £104.38	XSQ44650K £144.40	XSQ55650K £177.46

RECTANGULAR EARBANDS								
Description	Premier [Primed]				Premier Extra [Black]			
	"100 x 75mm [4" x 3"]"	"125 x 70mm [5" x 2.75"]"	"125 x 100mm [5" x 4"]"	"150 x 100mm [6" x 4"]"	"100 x 75mm [4" x 3"]"	"125 x 70mm [5" x 2.75"]"	"125 x 100mm [5" x 4"]"	"150 x 100mm [6" x 4"]"
Ornamental Type A	RT43650A £92.55	RT53650A £152.94	RT54650A £139.66	RT64650A £168.98	XRT43650A £97.17	XRT53650A £160.63	XRT54650A £160.63	XRT64650A £177.46
Ornamental Type B	RT43650B £92.55	RT53650B £152.94	RT54650B £139.66	RT64650B £168.98	XRT43650B £97.17	XRT53650B £160.63	XRT54650B £160.63	XRT64650B £177.46
Ornamental Type C	RT43650C £92.55	RT53650C £152.94	RT54650C £139.66	RT64650C £168.98	XRT43650C £97.17	XRT53650C £160.63	XRT54650C £160.63	XRT64650C £177.46
Ornamental Type D	RT43650D £78.43	RT53650D £129.61	RT54650D £118.36	RT64650D £143.21	XRT43650D £82.35	XRT53650D £136.13	XRT54650D £136.13	XRT64650D £150.39
Ornamental Type E	RT43650E £92.55	RT53650E £152.94	RT54650E £139.66	RT64650E £168.98	XRT43650E £97.17	XRT53650E £160.63	XRT54650E £160.63	XRT64650E £177.46
Ornamental Type F	RT43650F £92.55	RT53650F £152.94	RT54650F £139.66	RT64650F £168.98	XRT43650F £97.17	XRT53650F £160.63	XRT54650F £160.63	XRT64650F £177.46
Ornamental Type G	RT43650G £92.55	RT53650G £152.94	RT54650G £139.66	RT64650G £168.98	XRT43650G £97.17	XRT53650G £160.63	XRT54650G £160.63	XRT64650G £177.46
Ornamental Type J	RT43650J £92.55	RT53650J £152.94	RT54650J £139.66	RT64650J £168.98	XRT43650J £97.17	XRT53650J £160.63	XRT54650J £160.63	XRT64650J £177.46
Ornamental Type K	RT43650K £92.55	RT53650K £152.94	RT54650K £139.66	RT64650K £168.98	XRT43650K £97.17	XRT53650K £160.63	XRT54650K £160.63	XRT64650K £177.46

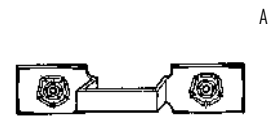

A

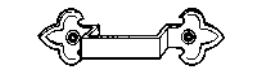

B

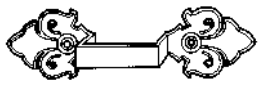

C

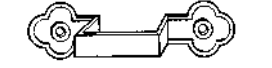

D

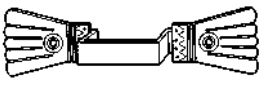

E



F

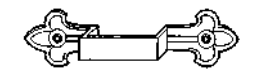

G

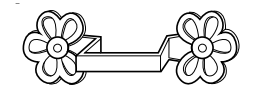

J



K

Ornamental Earbands are available for round, square or rectangular pipes.

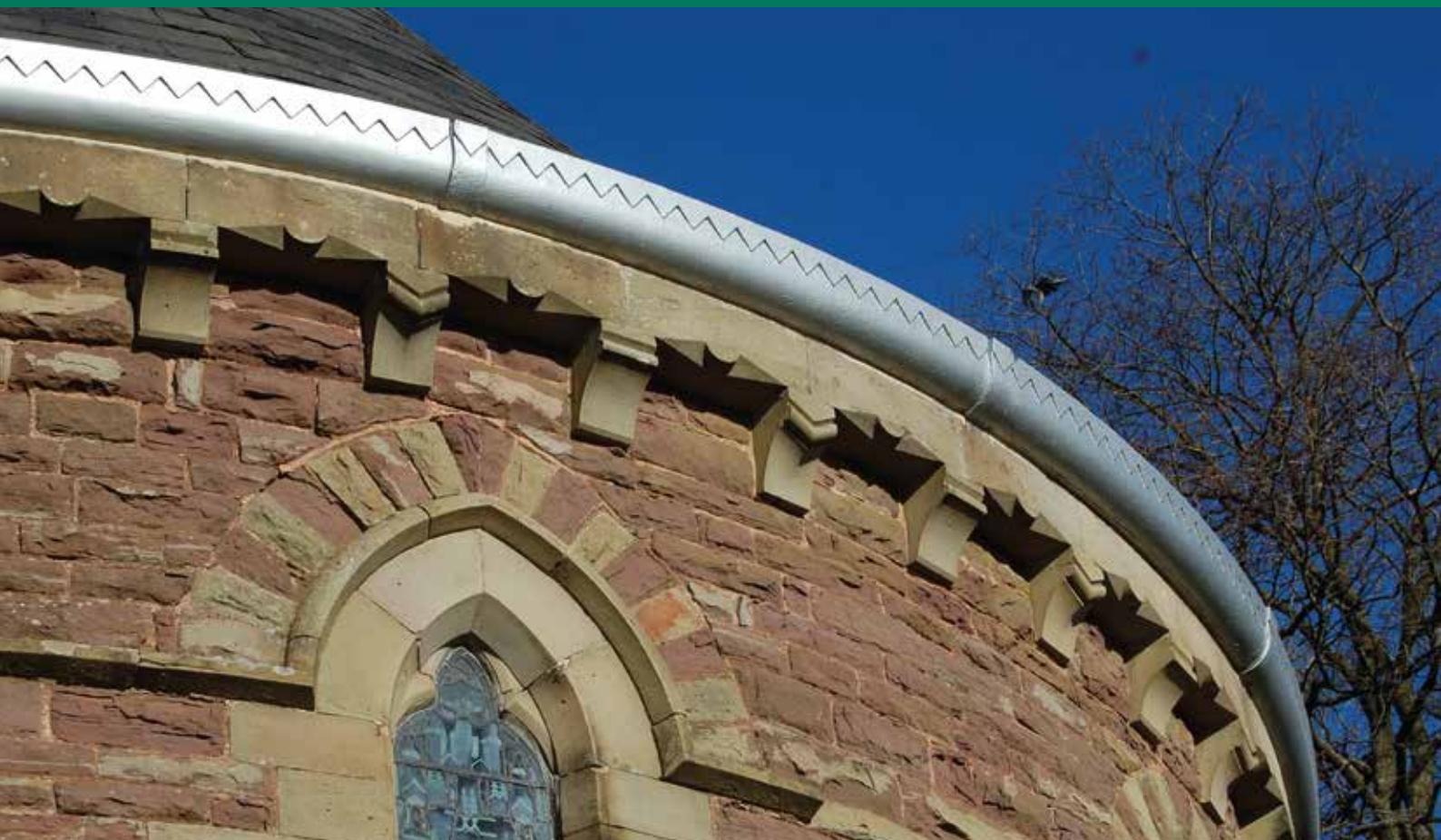

RAINWATER GUTTERS MADE TO ORDER



H3 PLAIN DEEP HALF ROUND	31	H16 MOULDED	45
H3A DOUBLE BEADED DEEP HALF ROUND	32	H38 MOULDED	46
H3B SINGLE BEADED DEEP HALF ROUND	33	H39 MOULDED	47
H25 SOCKET & SPIGOT BOX	34	H44 MOULDED	48
H25S SOCKET & SPIGOT BOX	35	H46 MOULDED	49
H23 DEEP OG	36	H47D MOULDED	50
H23D DEEP OGD	37	RADIUS GUTTERS	51
H10 MOULDED	38	H49 MOULDED	52
H12 MOULDED	39	H60 MOULDED	53
H12S MOULDED	40	H77 MOULDED	54
H13 MOULDED	41	H78 MOULDED	55
H14 MOULDED	42	H80 MOULDED	56
H14S MOULDED	43-44	H101 MOULDED	57
		H102 MOULDED	58

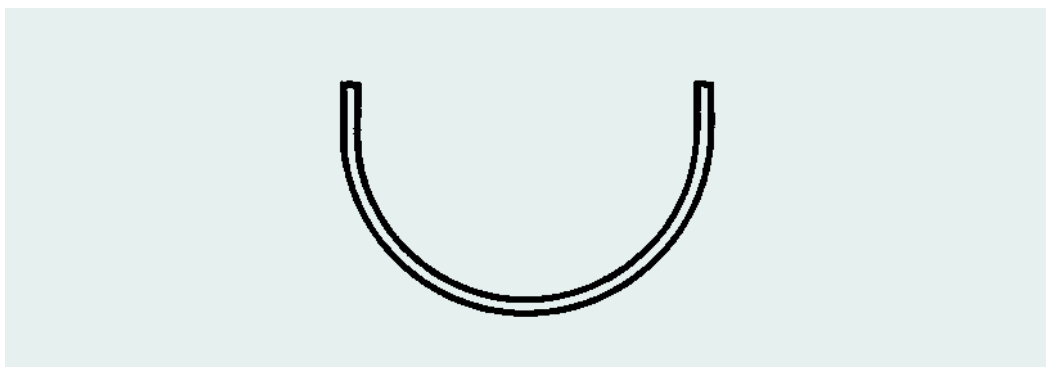

H3

PLAIN DEEP
HALF ROUND

Size [mm]	125 X 100mm	150 X 100mm	200 X 100mm
Size [inches]	5" X 4"	6" X 4"	8" X 4"
1829mm (6FT)	H35401 £524.83	H36401 £587.06	H38401 £950.27

GUTTERS

Left Hand	H35410 £262.40	H36410 £293.57	H38410 £475.13
Right Hand	H35411 £262.40	H36411 £293.57	H38411 £475.13

SQUARE 90 DEGREE ANGLES

Left Hand	H35412 £262.40	H36412 £293.57	H38412 £475.13
Right Hand	H35413 £262.40	H36413 £293.57	H38413 £475.13

OBTUSE 135 DEGREE ANGLES

A = 65mm B = 75mm C = 100mm			
Nozzle	H35420 £262.40	H36420 £293.57	H38420 £475.13
Dropepd External	H35421 £262.40	H36421 £293.57	H38421 £475.13
Dropepd Internal	H35422 £262.40	H36422 £293.57	H38422 £475.13

OUTLETS

External	H35430 £87.39	H36430 £97.85	H38430 £158.38
Internal	H35431 £87.39	H36431 £97.85	H38431 £158.38

STOPENDS

	H35435 £87.39	H36435 £97.85	H38435 £158.38
--	-------------------------	-------------------------	--------------------------

UNION CLIPS

	H35440 £43.72	H36440 £48.93	H38440 £79.18
--	-------------------------	-------------------------	-------------------------

FASCIA BRACKETS



Products can be supplied in any RAL or BS colour.
We can also colour match from customer supplied samples.
Price on application.

H3A

DOUBLE BEADED
DEEP HALF
ROUND



GUTTERS

Size [mm]	125 X 100mm	150 X 100mm	200 X 100mm
Size [inches]	5" X 4"	6" X 4"	8" X 4"
1829mm [6FT]	H3A5401 £524.83	H3A6401 £587.06	H3A8401 £950.27

SQUARE 90 DEGREE ANGLES

Left Hand	H3A5410 £262.40	H3A6410 £293.57	H3A8410 £475.13
Right Hand	H3A5411 £262.40	H3A6411 £293.57	H3A8411 £475.13

OBTUSE 135 DEGREE ANGLES

Left Hand	H3A5412 £262.40	H3A6412 £293.57	H3A8412 £475.13
Right Hand	H3A5413 £262.40	H3A6413 £293.57	H3A8413 £475.13

OUTLETS

A = 65mm B = 75mm C = 100mm			
Nozzle	H3A5420 £262.40	H3A6420 £293.57	H3A8420 £475.13
Dropeend External	H3A5421 £262.40	H3A6421 £293.57	H3A8421 £475.13
Dropeend Internal	H3A5422 £262.40	H3A6422 £293.57	H3A8422 £475.13

STOPENDS

External	H3A5430 £87.39	H3A6430 £97.85	H3A8430 £158.38
Internal	H3A5431 £87.39	H3A6431 £97.85	H3A8431 £158.38

UNION CLIPS

	H3A5435 £87.39	H3A6435 £97.85	H3A8435 £158.38
--	--------------------------	--------------------------	---------------------------

FASCIA BRACKETS

	H3A5440 £43.71	H3A6440 £48.93	H3A8440 £79.18
--	--------------------------	--------------------------	--------------------------



Products can be supplied in any RAL or BS colour.
We can also colour match from customer supplied samples.
Price on application.

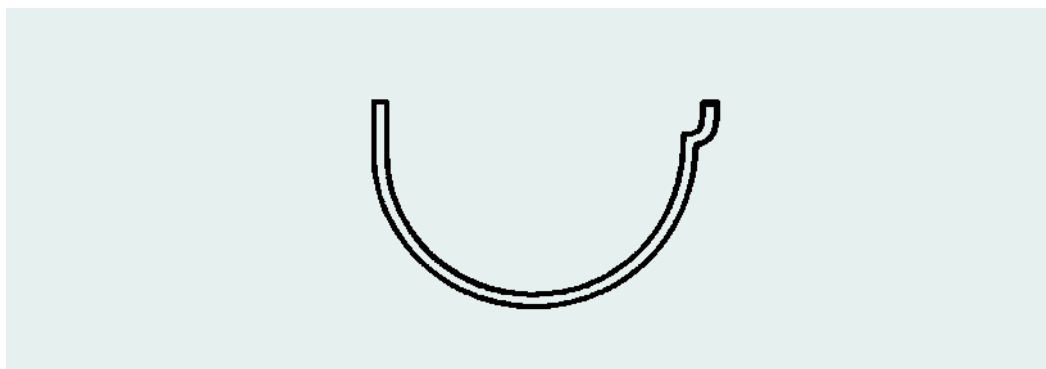

H3B

SINGLE BEADED
DEEP HALF
ROUND

Size [mm]	125 X 100mm	150 X 100mm	200 X 100mm
Size [inches]	5" X 4"	6" X 4"	8" X 4"
1829mm (6FT)	H3B5401 £524.83	H3B6401 £587.06	H3B8401 £950.27

GUTTERS

External	H3B5410 £262.40	H3B6410 £293.57	H3B8410 £475.13
Internal	H3B5411 £262.40	H3B6411 £293.57	H3B8411 £475.13

SQUARE 90 DEGREE ANGLES

External	H3B5412 £262.40	H3B6412 £293.57	H3B8412 £475.13
Internal	H3B5413 £262.40	H3B6413 £293.57	H3B8413 £475.13

OBTUSE 135 DEGREE ANGLES

A = 65mm B = 75mm C = 100mm			
Nozzle	H3B5420 £262.40	H3B6420 £293.57	H3B8420 £475.13
Dropepd External	H3B5421 £262.40	H3B6421 £293.57	H3B8421 £475.13
Dropepd Internal	H3B5422 £262.40	H3B6422 £293.57	H3B8422 £475.13

OUTLETS

External	H3B5430 £87.39	H3B6430 £97.85	H3B8430 £158.38
Internal	H3B5431 £87.39	H3B6431 £97.85	H3B8431 £158.38

STOPENDS

	H3B5435 £87.39	H3B6435 £97.85	H3B8435 £158.38
--	--------------------------	--------------------------	---------------------------

UNION CLIPS

	H3B5440 £43.71	H3B6440 £48.93	H3B8440 £79.18
--	--------------------------	--------------------------	--------------------------

FASCIA BRACKETS



Products can be supplied in any RAL or BS colour.
We can also colour match from customer supplied samples.
Price on application.

H25

SOCKET & SPIGOT BOX



GUTTERS

Size [mm]	100 X 100mm	125 X 100mm	150 X 75mm	150 X 100mm
Size [inches]	4" X 4"	5" X 4"	6" X 3"	6" X 4"
1829mm [6FT]	H254401 £627.21	H255401 £654.37	H256301 £721.71	H256401 £721.71

SQUARE 90 DEGREE ANGLES

Left Hand	H254410 £313.62	H255410 £327.19	H256310 £360.81	H256410 £360.81
Right Hand	H254411 £313.62	H255411 £327.19	H256311 £360.81	H256411 £360.81

OBTUSE 135 DEGREE ANGLES

Left Hand	H254412 £313.62	H255412 £327.19	H256312 £360.81	H256412 £360.81
Right Hand	H254413 £313.62	H255413 £327.19	H256313 £360.81	H256413 £360.81

OUTLETS

A = 65mm B = 75mm C = 100mm				
Nozzle	H254420 £313.62	H255420 £327.19	H256320 £360.81	H256420 £360.81
Dropeend External	H254421 £313.62	H255421 £327.19	H256321 £360.81	H256421 £360.81
Dropeend Internal	H254422 £313.62	H255422 £327.19	H256322 £360.81	H256422 £360.81

STOPENDS

External	H254430 £104.88	H255430 £109.12	H256330 £120.30	H256430 £120.30
Internal	H254431 £104.88	H255431 £109.12	H256331 £120.30	H256431 £120.30

UNION CLIPS

	H254435 £104.88	H255435 £109.12	H256335 £120.30	H256435 £120.30
--	---------------------------	---------------------------	---------------------------	---------------------------

FASCIA BRACKETS

	H254440 £52.30	H255440 £54.56	H256340 £60.17	H256440 £60.17
--	--------------------------	--------------------------	--------------------------	--------------------------



Products can be supplied in any RAL or BS colour.
We can also colour match from customer supplied samples.
Price on application.

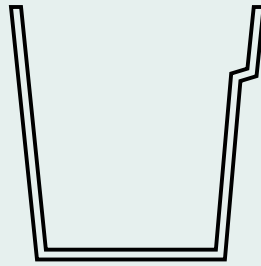

H25S

SOCKET & SPIGOT BOX

Size [mm]	150 X 150mm
Size [inches]	6" X 6"
1829mm (6FT)	H25S6601 £1,062.67
External	H25S6610 £531.36
Internal	H25S6611 £531.36
External	H25S6612 £531.36
Internal	H25S6613 £531.36
A = 65mm B = 75mm C = 100mm	
Nozzle	H25S6620 £531.36
Dropond External	H25S6621 #N/A
Dropond Internal	H25S6622 #N/A
External	H25S6630 £177.12
Internal	H25S6631 £177.12
	H25S6635 £177.12
	H25S6640 £88.56

GUTTERS

SQUARE 90 DEGREE ANGLES

OBTUSE 135 DEGREE ANGLES

OUTLETS

STOPENDS

UNION CLIPS

FASCIA BRACKETS



Products can be supplied in any RAL or BS colour.
We can also colour match from customer supplied samples.
Price on application.

H23

DEEP OG



GUTTERS

Size [mm]	125 X 75mm	125 X 100mm	150 X 100mm	157 X 133mm	178 X 125mm	255 X 153mm
Size [inches]	5" X 3"	5" X 4"	6" X 4"	6.25" X 5.25"	7" X 5"	10" X 6"
1829mm [6FT]	H235301 £623.42	H235401 £634.42	H236401 £642.16	H236501R £660.61	H237501 £872.60	H2310601R £1,179.88

SQUARE 90 DEGREE ANGLES

Left Hand or External	H235310 £311.72	H235410 £317.25	H236410 £321.11	H236510R £330.28	H237510 £436.18	H2310610R £589.94
Right Hand or Internal	H235311 £311.72	H235411 £317.25	H236411 £321.11	H236511R £330.28	H237511 £436.18	H2310611R £589.94

OBTUSE 135 DEGREE ANGLES

Left Hand or External	H235312 £311.72	H235412 £317.25	H236412 £321.11	H236512R £330.28	H237512 £436.18	H2310612R £589.94
Right Hand or Internal	H235313 £311.72	H235413 £317.25	H236413 £321.11	H236513R £330.28	H237513 £436.18	H2310613R £589.94

OUTLETS

A = 65mm B = 75mm C = 100mm						
Nozzle	H235320 £311.72	H235420 £317.25	H236420 £321.11	H236520R £330.28	H237520 £436.18	H2310620R £589.94
Dropeend External	H235321 £311.72	H235421 £317.25	H236421 £321.11	H236521R £330.28	H237521 £436.18	H2310621R £589.94
Dropeend Internal	H235322 £311.72	H235422 £317.25	H236422 £321.11	H236522R £330.28	H237522 £436.18	H2310622R £589.94

STOPENDS

External	H235330 £103.95	H235430 £105.75	H236430 £107.07	H236530R £110.03	H237530 £145.54	H2310630R £196.65
Internal	H235331 £103.95	H235431 £105.75	H236431 £107.07	H236531R £110.03	H237531 £145.54	H2310631R £196.65

UNION CLIPS

	H235335 £103.95	H235435 £105.75	H236435 £107.07	H237535 £145.54	H237535 £145.54	H2310635R £196.65
--	---------------------------	---------------------------	---------------------------	---------------------------	---------------------------	-----------------------------

FASCIA BRACKETS

	H235340 £51.98	H235440 £52.87	H236440 £53.56	H236540R £55.02	H237540 £72.76	H2310640R £98.31
--	--------------------------	--------------------------	--------------------------	---------------------------	--------------------------	----------------------------



Products can be supplied in any RAL or BS colour.
We can also colour match from customer supplied samples.
Price on application.

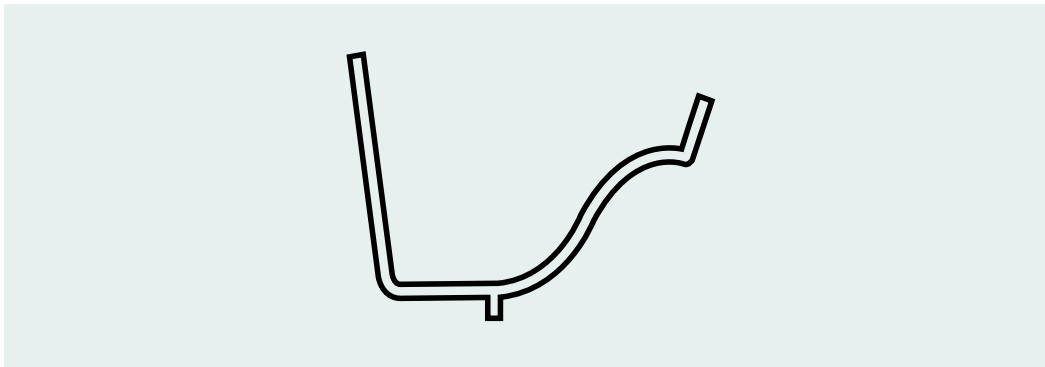

H23D

DEEP OG

Size [mm]	190 X 125mm
Size [inches]	7.5" X 5"
1829mm (6FT)	H23D0501R £975.00

GUTTERS

Left Hand or External	H23D0510R £479.91
Right Hand or Internal	H23D0511R £479.91

SQUARE 90 DEGREE ANGLES

Left Hand or External	H23D0512R £479.91
Right Hand or Internal	H23D0513R £479.91

OBTUSE 135 DEGREE ANGLES

A = 65mm B = 75mm C = 100mm	
Nozzle	H23D0520R £479.91
Dropend External	H23D0521R £479.91
Dropend Internal	H23D0522R £479.91

OUTLETS

External	H23D0530R £159.95
Internal	H23D0531R £159.95

STOPENDS

	H23D0535R £159.95
--	-----------------------------

UNION CLIPS

	H23D0540R £79.96
--	----------------------------

FASCIA BRACKETS



Products can be supplied in any RAL or BS colour.
We can also colour match from customer supplied samples.
Price on application.

H10

MOULDED

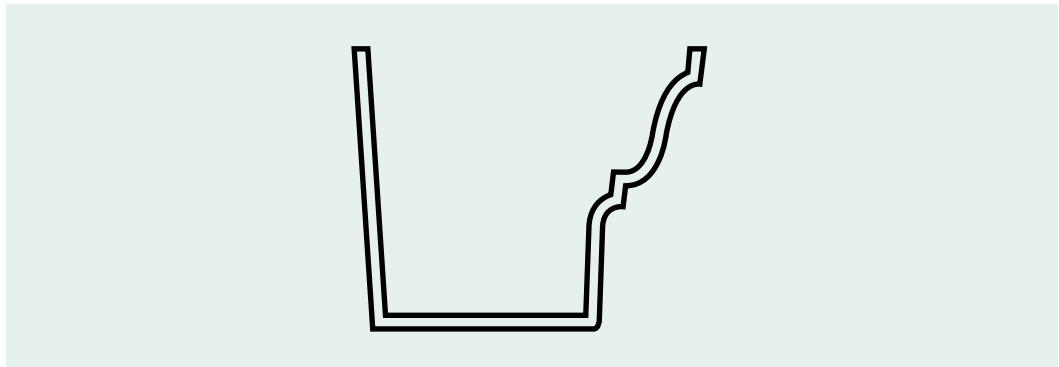

GUTTERS

Size [mm]	125 X 100mm	190 X 114mm	200 X 150mm	250 X 180mm
Size [inches]	5" X 4"	7.5" X 4.5"	8" X 6"	10" X 7"
1829mm [6FT]	H105401 £580.88	H108501R £816.28	H108601 £1,116.74	H1010701 £1,446.86

SQUARE 90 DEGREE ANGLES

External	H105410 £290.44	H108510R £408.31	H108610 £549.00	H1010710 £723.47
Internal	H105411 £290.44	H108511R £408.31	H108611 £549.00	H1010711 £723.47

OBTUSE 135 DEGREE ANGLES

External	H105412 £290.44	H108512R £408.31	H108612 £549.00	H1010712 £723.47
Internal	H105413 £290.44	H108513R £408.31	H108613 £549.00	H1010713 £723.47

OUTLETS

A = 65mm B = 75mm C = 100mm				
Nozzle	H105420 £290.44	H108520R £408.31	H108620 £549.00	H1010720 £723.47
Dropend External	H105421 £290.44	H108521R £408.31	H108621 £549.00	H1010721 £723.47
Dropend Internal	H105422 £290.44	H108522R £408.31	H108622 £549.00	H1010722 £723.47

STOPENDS

External	H105430 £96.86	H108530R £136.13	H108630 £183.00	H1010730 £241.20
Internal	H105431 £96.86	H108531R £136.13	H108631 £183.00	H1010731 £241.20

UNION CLIPS

	H105435 £96.86	H108535R £135.70	H108635 £183.00	H1010735 £241.20
--	--------------------------	----------------------------	---------------------------	----------------------------

FASCIA BRACKETS

	H105440 £48.44	H108540R £68.07	H108640 £91.48	H1010740 £120.59
--	--------------------------	---------------------------	--------------------------	----------------------------



Products can be supplied in any RAL or BS colour.
We can also colour match from customer supplied samples.
Price on application.

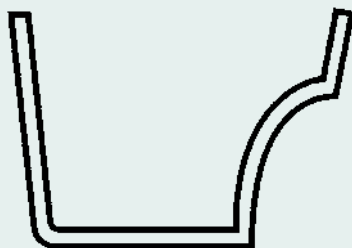

H12

MOULDED

Size [mm]	105 X 75mm	125 X 100mm	150 X 100mm
Size [inches]	4" X 3"	5" X 4"	6" X 4"
1829mm (6FT)	H124301 £524.83	H125401 £593.87	H126401 £623.42

External	H124310 £262.40	H125410 £311.06	H126410 £311.72
Internal	H124311 £262.40	H125411 £311.06	H126411 £311.72

External	H124312 £262.40	H125412 £311.06	H126412 £311.72
Internal	H124313 £262.40	H125413 £311.06	H126413 £311.72

A = 65mm B = 75mm C = 100mm			
Nozzle	H124320 £262.40	H125420 £311.06	H126420 £311.72
Dropepd External	H124321 £262.40	H125421 £311.06	H126421 £311.72
Dropepd Internal	H124322 £262.40	H125422 £311.06	H126422 £311.72

External	H124330 £87.39	H125430 £103.71	H126430 £103.95
Internal	H124331 £87.39	H125431 £103.71	H126431 £103.95

	H124335 £87.39	H125435 £103.71	H126435 £103.95
--	--------------------------	---------------------------	---------------------------

	H124340 £43.70	H125440 £51.87	H126440 £51.98
--	--------------------------	--------------------------	--------------------------

GUTTERS

SQUARE 90
DEGREE ANGLES

OBTUSE 135
DEGREE ANGLES

OUTLETS

STOPENDS

UNION CLIPS

FASCIA BRACKETS

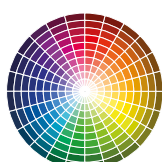

Products can be supplied in any RAL or BS colour.
We can also colour match from customer supplied samples.
Price on application.

H12S

MOULDED

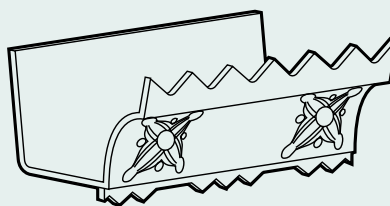

GUTTERS

Size [mm]	133 X 100mm
Size [inches]	5.25" X 4"
1829mm [6FT]	H12S5401R £1,088.18

SQUARE 90 DEGREE ANGLES

External	H12S5410R £544.03
Internal	H12S5411R £544.03

OBTUSE 135 DEGREE ANGLES

External	H12S5412R £544.03
Internal	H12S5413R £544.03

OUTLETS

A = 65mm B = 75mm C = 100mm	
Nozzle	H12S5420R £544.03
Dropead External	H12S5421R £544.03
Dropead Internal	H12S5422R £544.03

STOPENDS

External	H12S5430R £181.37
Internal	H12S5431R £181.37

UNION CLIPS

	H12S5435R £181.37
--	-----------------------------

FASCIA BRACKETS

	H12S5440R £90.68
--	----------------------------



Products can be supplied in any RAL or BS colour.
We can also colour match from customer supplied samples.
Price on application.

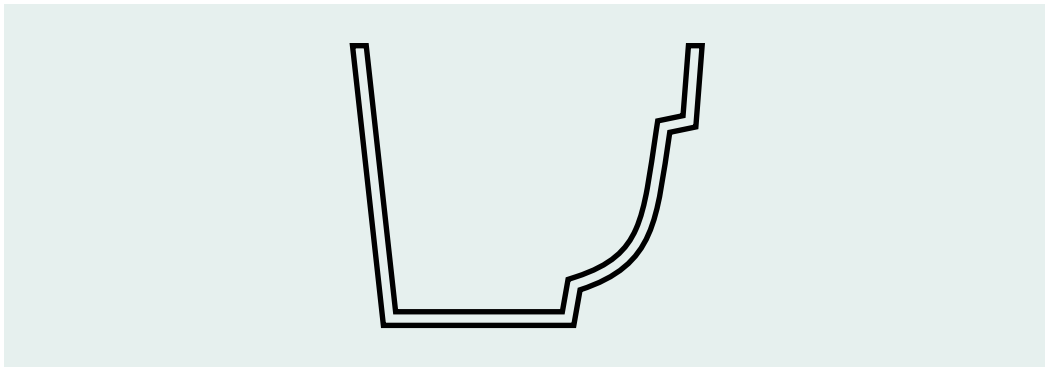

H13

MOULDED

Size [mm]	125 X 100mm
Size [inches]	5" X 4"
1829mm (6FT)	H135401 £629.12

GUTTERS

External	H135410 £314.58
Internal	H135411 £314.58

SQUARE 90 DEGREE ANGLES

External	H135412 £314.58
Internal	H135413 £314.58

OBTUSE 135 DEGREE ANGLES

A = 65mm B = 75mm C = 100mm	
Nozzle	H135420 £314.58
Dropepd External	H135421 £314.58
Dropepd Internal	H135422 £314.58

OUTLETS

External	H135430 £104.83
Internal	H135431 £104.83

STOPENDS

	H135435 £104.83
--	---------------------------

UNION CLIPS

	H135440 £52.41
--	--------------------------

FASCIA BRACKETS



Products can be supplied in any RAL or BS colour.
We can also colour match from customer supplied samples.
Price on application.

H14

MOULDED

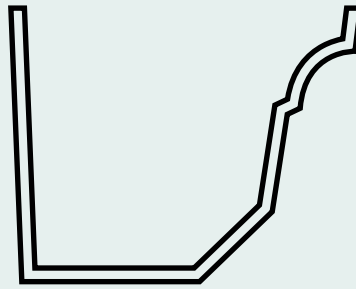

GUTTERS

Size [mm]	125 X 115mm	150 X 100mm	150 X 115mm
Size [inches]	5" X 4.5"	6" X 4"	6" X 4.5"
1829mm [6FT]	H145501R £691.96	H146401 £642.24	H146501R £733.57

SQUARE 90 DEGREE ANGLES

External	H145510R £346.02	H146410 £321.11	H146510R £366.77
Internal	H145511R £346.02	H146411 £321.11	H146511R £366.77

OBTUSE 135 DEGREE ANGLES

External	H145512R £346.02	H146412 £321.11	H146512R £366.77
Internal	H145513R £346.02	H146413 £321.11	H146513R £366.77

OUTLETS

A = 65mm B = 75mm C = 100mm			
Nozzle	H145520R £346.02	H146420 £321.11	H146520R £366.77
Dropead External	H145521R £346.02	H146421 £321.11	H146521R £366.77
Dropead Internal	H145522R £346.02	H146422 £321.11	H146522R £366.77

STOPENDS

External	H145530R £115.29	H146430 £107.03	H146530R £122.29
Internal	H145531R £115.29	H146431 £107.03	H146531R £122.29

UNION CLIPS

	H145535R £115.29	H146435 £107.03	H146535R £122.29
--	----------------------------	---------------------------	----------------------------

FASCIA BRACKETS

	H145540R £57.66	H146440 £53.54	H146540R £61.15
--	---------------------------	--------------------------	---------------------------



Products can be supplied in any RAL or BS colour.
We can also colour match from customer supplied samples.
Price on application.

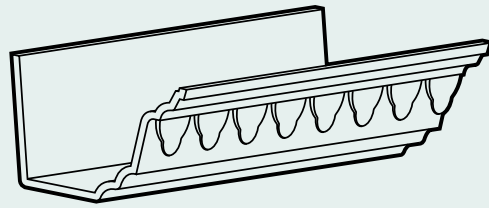

H14S

MOULDED

Size [mm]	150 X 100mm
Size [inches]	6" X 4"
1829mm (6FT)	H14S6401 £1,152.91

External	H14S6410 £576.45
Internal	H14S6411 £576.45

External	H14S6412 £576.45
Internal	H14S6413 £576.45

A = 65mm B = 75mm C = 100mm	
Nozzle	H14S6420 £576.45
Dropepd External	H14S6421 £576.45
Dropepd Internal	H14S6422 £576.45

External	H14S6430 £192.13
Internal	H14S6431 £192.13

	H14S6435 £192.13
--	----------------------------

	H14S6440 £96.08
--	---------------------------

GUTTERS

SQUARE 90
DEGREE ANGLES

OBTUSE 135
DEGREE ANGLES

OUTLETS

STOPENDS

UNION CLIPS

FASCIA BRACKETS



Products can be supplied in any RAL or BS colour.
We can also colour match from customer supplied samples.
Price on application.

H14S

MOULDED

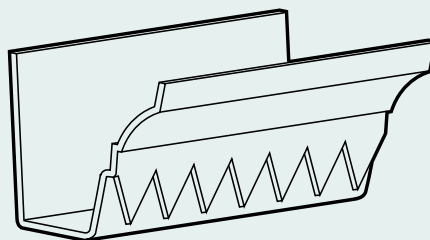

GUTTERS

Size [mm]	150 X 150mm
Size [inches]	6" X 6"
1829mm [6FT]	H14S6601 £1,268.20

SQUARE 90 DEGREE ANGLES

External	H14S6610 £634.11
Internal	H14S6611 £634.11

OBTUSE 135 DEGREE ANGLES

External	H14S6612 £634.11
Internal	H14S6613 £634.11

OUTLETS

A = 65mm B = 75mm C = 100mm	
Nozzle	H14S6620 £634.11
Dropead External	H14S6621 £634.11
Dropead Internal	H14S6622 £634.11

STOPENDS

External	H14S6630 £211.32
Internal	H14S6631 £211.32

UNION CLIPS

	H14S6635 £211.32
--	----------------------------

FASCIA BRACKETS

	H14S6640 £105.66
--	----------------------------



Products can be supplied in any RAL or BS colour.
We can also colour match from customer supplied samples.
Price on application.

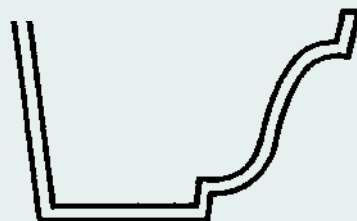

H16

MOULDED

GUTTERS

SQUARE 90 DEGREE ANGLES

OBTUSE 135 DEGREE ANGLES

OUTLETS

STOPENDS

UNION CLIPS

FASCIA BRACKETS

Size [mm]	160 X 115mm	230 X 115mm	292 X 127mm
Size [inches]	6.5" X 4.5"	9" X 4.5"	11.5" X 5"
1829mm (6FT)	H167401R £596.37	H169501R £1,152.91	H1612501R £1,252.67

External	H167410R £298.17	H169510R £576.45	H1612510R £626.39
Internal	H167411R £298.17	H169511R £576.45	H1612511R £626.39

External	H167412R £298.17	H169512R £576.45	H1612512R £626.39
Internal	H167413R £298.17	H169513R £576.45	H1612513R £626.39

A = 65mm B = 75mm C = 100mm			
Nozzle	H167420R £298.17	H169520R £576.45	H1612520R £626.39
Dropepd External	H167421R £298.17	H169521R £576.45	H1612521R £626.39
Dropepd Internal	H167422R £298.17	H169522R £576.45	H1612522R £626.39

External	H167430R £99.39	H169530R £192.13	H1612530R £208.84
Internal	H167431R £99.39	H169531R £192.13	H1612531R £208.84

	H167435R £99.39	H169535R £192.13	H1612535R £208.84
--	---------------------------	----------------------------	-----------------------------

	H167440R £49.70	H169540R £96.08	H1612540R £104.43
--	---------------------------	---------------------------	-----------------------------



Products can be supplied in any RAL or BS colour.
We can also colour match from customer supplied samples.
Price on application.

H38

MOULDED

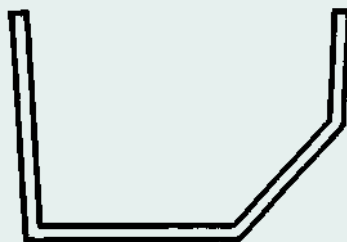

GUTTERS

Size [mm]	150 X 125mm
Size [inches]	6" X 5"
1829mm [6FT]	H386501 £685.25

SQUARE 90 DEGREE ANGLES

External	H386510 £342.64
Internal	H386511 £342.64

OBTUSE 135 DEGREE ANGLES

External	H386512 £342.64
Internal	H386513 £342.64

OUTLETS

A = 65mm B = 75mm C = 100mm	
Nozzle	H386520 £342.64
Dropead External	H386521 £342.64
Dropead Internal	H386522 £342.64

STOPENDS

External	H386530 £114.22
Internal	H386531 £114.22

UNION CLIPS

	H386535 £114.22
--	---------------------------

FASCIA BRACKETS

	H386540 £57.13
--	--------------------------



Products can be supplied in any RAL or BS colour.
We can also colour match from customer supplied samples.
Price on application.

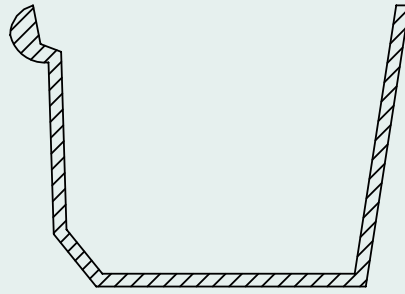

H39

MOULDED

Size [mm]	140 X 110mm	140 X 95mm
Size [inches]	5.5" X 4.5"	5.5" X 3.75"
1829mm (6FT)	H396401R £659.10	H396301R £657.08

External	H396410R £329.54	H396310R £328.54
Internal	H396411R £329.54	H396311R £328.54

External	H396412R £329.54	H396312R £328.54
Internal	H396413R £329.54	H396313R £328.54

A = 65mm B = 75mm C = 100mm		
Nozzle	H396420R £329.54	H396320R £328.54
Dropond External	H396421R £329.54	H396321R £328.54
Dropond Internal	H396422R £329.54	H396322R £328.54

External	H396430R £109.85	H396330R £109.53
Internal	H396431R £109.85	H396331R £109.53

	H396435R £109.85	H396335R £109.53
--	----------------------------	----------------------------

	H396440R £54.92	H396340R £54.76
--	---------------------------	---------------------------

GUTTERS

SQUARE 90
DEGREE ANGLES

OBTUSE 135
DEGREE ANGLES

OUTLETS

STOPENDS

UNION CLIPS

FASCIA BRACKETS



Products can be supplied in any RAL or BS colour.
We can also colour match from customer supplied samples.
Price on application.

H44

MOULDED

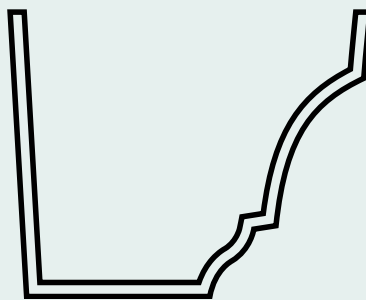

GUTTERS

Size [mm]	180 X 125mm	215 X 150mm
Size [inches]	7" X 5"	8.5" X 6"
1829mm [6FT]	H447501 £959.78	H448601R £1,098.08

SQUARE 90 DEGREE ANGLES

External	H447510 £479.91	H448610R £549.03
Internal	H447511 £479.91	H448611R £549.03

OBTUSE 135 DEGREE ANGLES

External	H447512 £479.91	H448612R £549.03
Internal	H447513 £479.91	H448613R £549.03

OUTLETS

A = 65mm B = 75mm C = 100mm		
Nozzle	H447520 £479.91	H448620R £549.03
Dropead External	H447521 £479.91	H448621R £549.03
Dropead Internal	H447522 £479.91	H448622R £549.03

STOPENDS

External	H447530 £159.95	H448630R £183.03
Internal	H447531 £159.95	H448631R £183.03

UNION CLIPS

	H447535 £159.95	H448635R £183.03
--	---------------------------	----------------------------

FASCIA BRACKETS

	H447540 £79.96	H448640R £91.54
--	--------------------------	---------------------------



Products can be supplied in any RAL or BS colour.
We can also colour match from customer supplied samples.
Price on application.

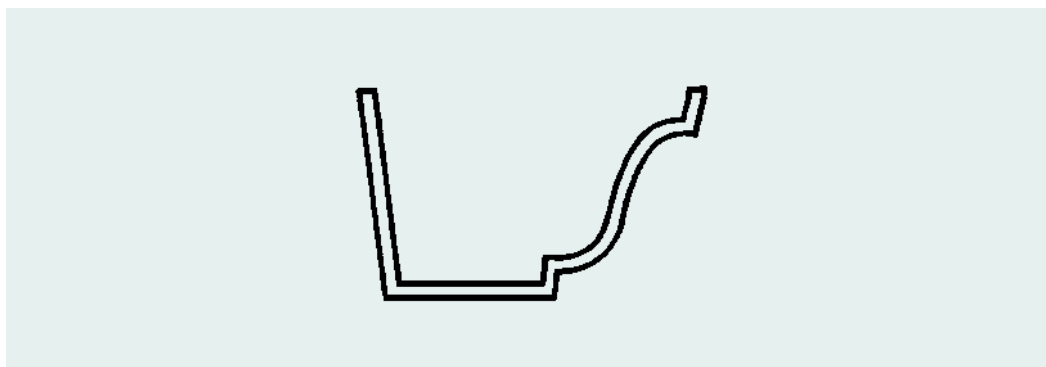

H46

MOULDED

Size [mm]	150 X 115mm	150 X 125mm	180 X 125mm	210 X 150mm	305 X 150mm
Size [inches]	6" X 4.5"	6" X 5"	7" X 5"	9.5" X 6"	12.2" X 6"
1829mm (6FT)	H466501R £646.65	H466501 £653.00	H467501 £979.35	H469601R £1,069.73	H4612601 £1,308.67

GUTTERS

External	H466510R £323.32	H466510 £326.45	H467510 £489.73	H469610R £534.89	H4612610 £654.33
Internal	H466511R £323.32	H466511 £326.45	H467511 £489.73	H469611R £534.89	H4612611 £654.33

SQUARE 90 DEGREE ANGLES

External	H466512R £323.32	H466512 £330.28	H467512 £489.73	H469612R £534.89	H4612612 £654.33
Internal	H466513R £323.32	H466513 £330.28	H467513 £489.73	H469613R £534.89	H4612613 £654.33

OBTUSE 135 DEGREE ANGLES

A = 65mm B = 75mm C = 100mm					
Nozzle	H466520R £323.32	H466520 £326.45	H467520 £489.73	H469620R £534.89	H4612620 £654.33
Dropepd External	H466521R £323.32	H466521 £326.45	H467521 £489.73	H469621R £534.89	H4612621 £654.33
Dropepd Internal	H466522 £323.32	H466522 £326.45	H467522 £489.73	H469622R £534.89	H4612622 £654.33

OUTLETS

External	H466530R £107.76	H466530 £108.85	H467530 £163.25	H469630R £178.25	H4612630 £218.12
Internal	H466531R £107.76	H466531 £108.85	H467531 £163.25	H469631R £178.25	H4612631 £218.12

STOPENDS

	H466535R £107.76	H466535 £108.85	H467535 £163.25	H469635R £178.25	H4612635 £218.12
--	----------------------------	---------------------------	---------------------------	----------------------------	----------------------------

UNION CLIPS

	H466540R £53.87	H466540 £54.44	H467540 £81.63	H469640R £89.13	H4612640 £109.04
--	---------------------------	--------------------------	--------------------------	---------------------------	----------------------------

FASCIA BRACKETS



Products can be supplied in any RAL or BS colour.
 We can also colour match from customer supplied samples.
Price on application.

H47D

MOULDED

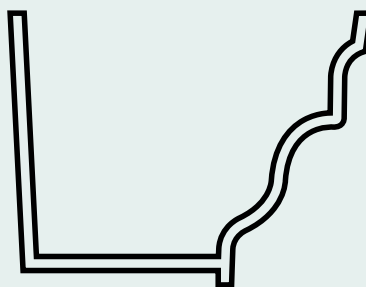

GUTTERS

Size [mm]	180 X 155mm
Size [inches]	7" X 6"
1829mm [6FT]	H47D7601 £1,078.31

SQUARE 90 DEGREE ANGLES

Left Hand or External	H47D7610 £539.17
Right Hand or Internal	H47D7611 £539.17

OBTUSE 135 DEGREE ANGLES

Left Hand or External	H47D7612 £539.17
Right Hand or Internal	H47D7613 £539.17

OUTLETS

A = 65mm B = 75mm C = 100mm	
Nozzle	H47D7620 £539.17
Dropead External	H47D7621 £539.17
Dropead Internal	H47D7622 £539.17

STOPENDS

External	H47D7630 £179.72
Internal	H47D7631 £179.72

UNION CLIPS

	H47D7635 £179.72
--	----------------------------

FASCIA BRACKETS

	H47D7640 £90.18
--	---------------------------



Products can be supplied in any RAL or BS colour.
We can also colour match from customer supplied samples.
Price on application.

RADIUS GUTTERS...



**HARGREAVES FOUNDRY DRAINAGE
CAN MANUFACTURE RADIUS
GUTTERS, IN ANY PROFILE, TO
SUIT YOUR REQUIREMENTS.**

For more information, prices, or to arrange a site visit,
contact Our Sales Office today.

H49

MOULDED

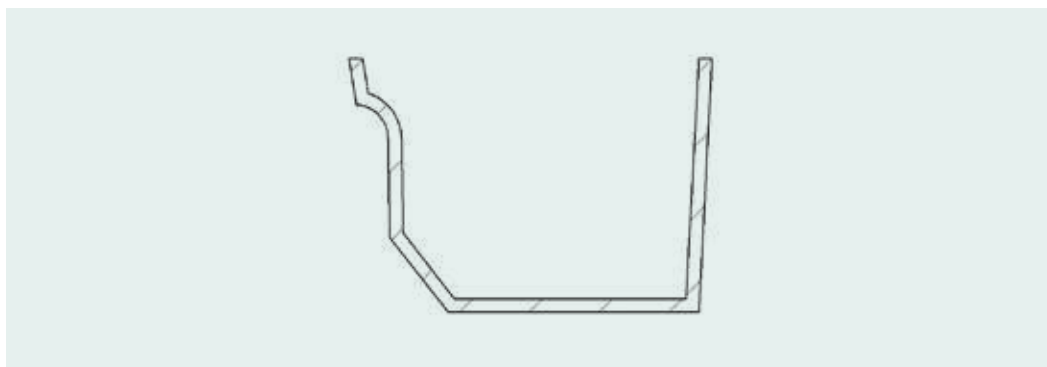

GUTTERS

Size [mm]	150 X 115mm
Size [inches]	6" X 4.5"
1829mm [6FT]	H496501R £639.42

SQUARE 90 DEGREE ANGLES

External	H496510R £319.71
Internal	H496511R £319.71

OBTUSE 135 DEGREE ANGLES

External	H496512R £319.71
Internal	H496513R £319.71

OUTLETS

A = 65mm B = 75mm C = 100mm	
Nozzle	H496520R £367.66
Dropead External	H496521R £367.66
Dropead Internal	H496522R £367.66

STOPENDS

External	H496530R £122.56
Internal	H496531R £122.56

UNION CLIPS

	H496535R £122.56
--	----------------------------

FASCIA BRACKETS

	H496540R £61.27
--	---------------------------



Products can be supplied in any RAL or BS colour.
We can also colour match from customer supplied samples.
Price on application.

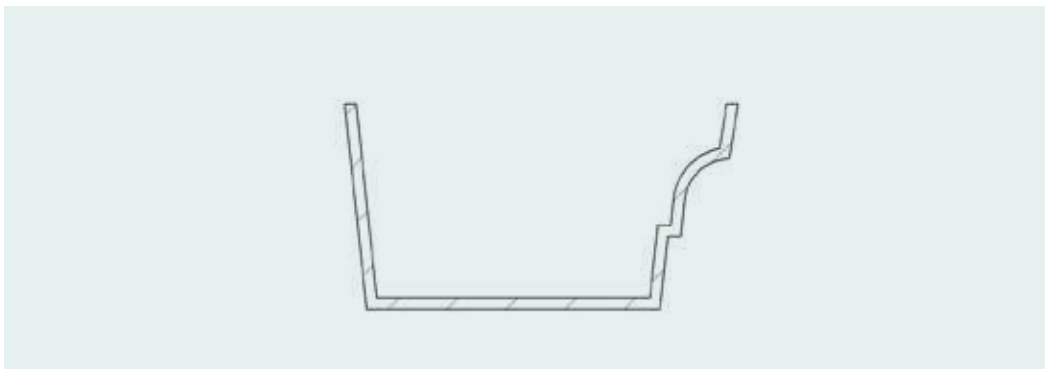

H60

MOULDED

Size [mm]	199 X 110mm
Size [inches]	7.8" X 4.3"
1829mm (6FT)	H608501R £923.54

GUTTERS

External	H608510R £461.78
Internal	H608511R £461.78

SQUARE 90 DEGREE ANGLES

External	H608512R £461.78
Internal	H608513R £461.78

OBTUSE 135 DEGREE ANGLES

A = 65mm B = 75mm C = 100mm	
Nozzle	H608520R £461.78
Dropepd External	H608521R £461.78
Dropepd Internal	H608522R £461.78

OUTLETS

External	H608530R £153.92
Internal	H608531R £153.92

STOPENDS

	H608535R £153.92
--	----------------------------

UNION CLIPS

	H608540R £76.96
--	---------------------------

FASCIA BRACKETS



Products can be supplied in any RAL or BS colour.
We can also colour match from customer supplied samples.
Price on application.

H77

MOULDED

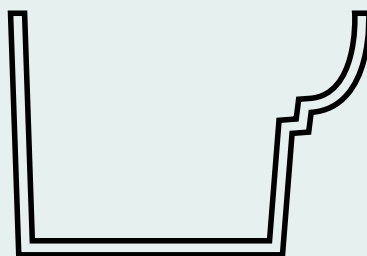

GUTTERS

Size [mm]	185 X 125mm
Size [inches]	7.25" X 5"
1829mm [6FT]	H777501R £1,089.32

SQUARE 90 DEGREE ANGLES

External	H777510R £544.66
Internal	H777511R £544.66

OBTUSE 135 DEGREE ANGLES

External	H777512R £544.66
Internal	H777513R £544.66

OUTLETS

A = 65mm B = 75mm C = 100mm	
Nozzle	H777520R £544.66
Dropend External	H777521R £544.66
Dropend Internal	H777522R £544.66

STOPENDS

External	H777530R £181.57
Internal	H777531R £181.57

UNION CLIPS

	H777535R £181.57
--	----------------------------

FASCIA BRACKETS

	H777540R £90.80
--	---------------------------



Products can be supplied in any RAL or BS colour.
We can also colour match from customer supplied samples.
Price on application.

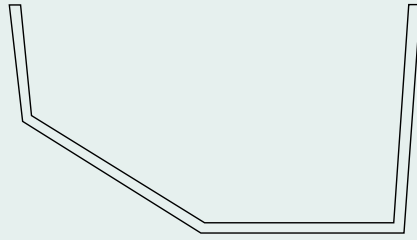

H78

MOULDED

Size [mm]	230 X 130mm
Size [inches]	9.5" X 5.5"
1829mm (6FT)	H789501R £887.28
External	H789510R £443.63
Internal	H789511R £443.63
External	H789512R £443.63
Internal	H789513R £443.63
A = 65mm B = 75mm C = 100mm	
Nozzle	H789520R £443.63
Dropepd External	H789521R £443.63
Dropepd Internal	H789522R £443.63
External	H789530R £147.87
Internal	H789531R £147.87
	H789535R £147.87
	H789540R £73.94

GUTTERS

SQUARE 90
DEGREE ANGLES

OBTUSE 135
DEGREE ANGLES

OUTLETS

STOPENDS

UNION CLIPS

FASCIA BRACKETS



Products can be supplied in any RAL or BS colour.
We can also colour match from customer supplied samples.
Price on application.

H80

MOULDED

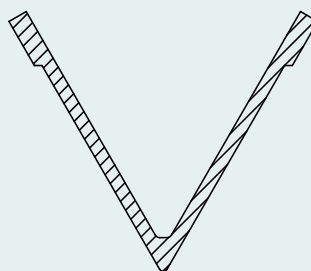

GUTTERS

Size [mm]	124 X 117.5mm
Size [inches]	5" X 4.5"
1829mm [6FT]	H805401R £694.94

SQUARE 90 DEGREE ANGLES

External	H805410R £347.48
Internal	H805411R £347.48

OBTUSE 135 DEGREE ANGLES

External	H805412R £347.48
Internal	H805413R £347.48

OUTLETS

A = 65mm B = 75mm C = 100mm	
Nozzle	H805420R £347.48
Dropend External	H805421R £347.48
Dropend Internal	H805422R £347.48

STOPENDS

External	H805430R £115.83
Internal	H805431R £115.83

UNION CLIPS

	H805435R £115.83
--	----------------------------

FASCIA BRACKETS

	H805440R £57.91
--	---------------------------



Products can be supplied in any RAL or BS colour.
We can also colour match from customer supplied samples.
Price on application.

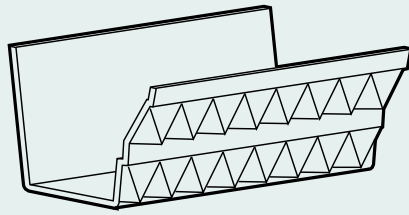

H101

MOULDED

Size [mm]	140 X 120mm
Size [inches]	5.5" X 4.75"
1829mm (6FT)	H1016501R £815.69

External	H1016510R £407.85
Internal	H1016511R £407.85

External	H1016512R £407.85
Internal	H1016513R £407.85

A = 65mm B = 75mm C = 100mm	
Nozzle	H1016520R £407.85
Dropepd External	H1016521R £407.85
Dropepd Internal	H1016522R £407.85

External	H1016530R £135.98
Internal	H1016531R £135.98

	H1016535R £135.98
--	-----------------------------

	H1016540R £68.00
--	----------------------------

GUTTERS

SQUARE 90
DEGREE ANGLES

OBTUSE 135
DEGREE ANGLES

OUTLETS

STOPENDS

UNION CLIPS

FASCIA BRACKETS



Products can be supplied in any RAL or BS colour.
We can also colour match from customer supplied samples.
Price on application.

H102

MOULDED

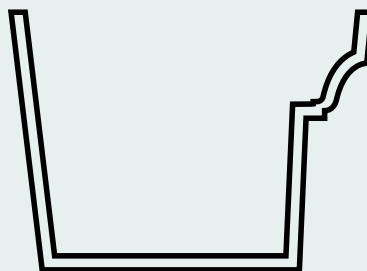

GUTTERS

Size [mm]	180 X 125mm
Size [inches]	7" X 5"
1829mm [6FT]	H1027501 £1,071.70

SQUARE 90 DEGREE ANGLES

External	H1027510 £535.83
Internal	H1027511 £535.83

OBTUSE 135 DEGREE ANGLES

External	H1027512 £535.83
Internal	H1027513 £535.83

OUTLETS

A = 65mm B = 75mm C = 100mm	
Nozzle	H1027520 £535.83
Dropead External	H1027521 £535.83
Dropead Internal	H1027522 £535.83

STOPENDS

External	H1027530 £178.61
Internal	H1027531 £178.61

UNION CLIPS

	H1027535 £178.61
--	----------------------------

FASCIA BRACKETS

	H1027540 £89.32
--	---------------------------



Products can be supplied in any RAL or BS colour.
We can also colour match from customer supplied samples.
Price on application.



RAINWATER HEADS MADE TO ORDER



ORNAMENTAL HEADS

60-64

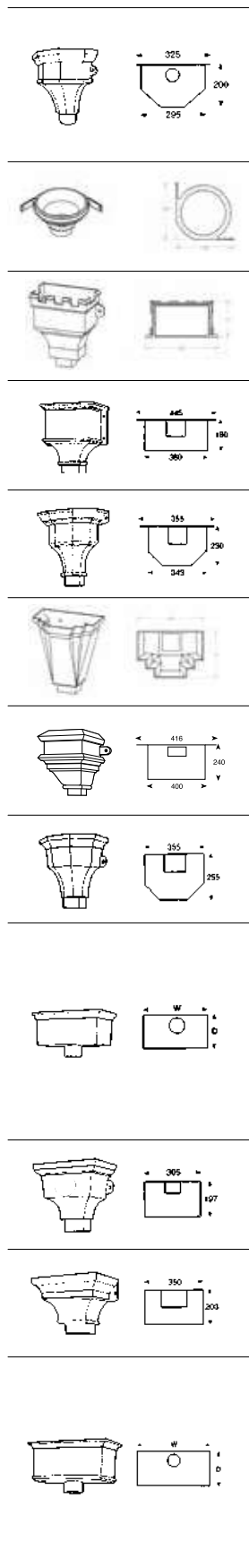

ORNAMENTAL HEADS			
Description	Width x Depth x Height	Premier [Primed]	Premier Extra [Black]
H2	325mm x 200mm x 290mm	RH2 £706.95	XRH2 £813.00
H3A	263mm x 263mm x 116mm	RH3A £674.58	XRH3A £742.04
H7	341mm x 171mm x 330mm	RH7 £780.59	XRH7 £897.67
H11	445mm x 180mm x 370mm	RH11 £754.95	XRH11 £868.20
H12	355mm x 230mm x 305mm	RH12 £856.23	XRH12 £984.70
H17	380mm x 265mm x 395mm	RH17 £892.51	XRH17 £869.83
H37	416mm x 240mm x 460mm	RH37 £990.34	XRH37 £1,138.91
H40	355mm x 255mm x 305mm	RH40 £856.23	XRH40 £984.70
H42 305mm [12"]	305mm x 184mm x 150mm	RH4212 £291.69	XRH4212 £335.08
H42 355mm [14"]	355mm x 184mm x 150mm	RH4214 £329.05	XRH4214 £411.32
H42 457mm [18"]	457mm x 184mm x 150mm	RH4218 £387.82	XRH4218 £484.77
H42 610mm [24"]	610mm x 184mm x 150mm	RH4224 £606.83	XRH4224 £697.90
H55	305mm x 197mm x 255mm	RH55 £739.74	XRH55 £850.74
H58	350mm x 203mm x 203mm	RH58 £624.31	XRH58 £717.96
H82 355mm [14"]	355mm x 235mm x 200mm	RH8214 £483.86	XRH8214 £556.43
H82 482mm [19"]	482mm x 235mm x 200mm	RH8219 £829.90	XRH8219 £954.36
H82 610mm [24"]	610mm x 235mm x 200mm	RH8224 £1,008.87	XRH8224 £1,160.23
H82 762mm [30"]	762mm x 235mm x 200mm	RH8230 £1,224.96	XRH8230 £1,408.71

Heads are supplied with embellishments as shown and can be customised on request. Please check suitability of required outlet. Other colours available on request – POA.



Products can be supplied in any RAL or BS colour.
We can also colour match from customer supplied samples.
Price on application.

ORNAMENTAL HEADS			
Description	Width x Depth x Height	Premier [Primed]	Premier Extra [Black]
H86	420mm x 215mm x 305mm	RH86 £1,227.44	XRH86 £1,409.81
H91	355mm x 160mm x 343mm	RH91 £1,088.52	XRH91 £1,251.80
H97 Flat Back	320mm x 197mm x 232mm	RH97 £639.91	XRH97 £735.94
H97A Corner	210mm x 210mm x 292mm	RH97A £639.91	XRH97A £735.94
H100	490mm x 240mm x 210mm	RH100 £953.12	XRH100 £1,096.04
H107 Flat Back	295mm x 1970mm x 292mm	RH107 £612.27	XRH107 £734.72
H107A	205mm x 205mm x 292mm	RH107A £612.27	XRH107A £734.72
H108	430mm x 220mm x 335mm	RH108 £814.49	XRH108 £936.67
H132	380mm x 265mm x 435mm	RH132 £1,103.75	XRH132 £1,269.31
H169	300mm x 197mm x 222mm	RH169 £595.60	XRH169 £684.98
H178	495mm x 210mm x 375mm	RH178 £1,187.48	XRH178 £1,365.61
H499	820mm x 210mm x 370mm	RH499 £1,630.35	XRH499 £1,874.85
H500	470mm x 230mm x 640mm	RH500 £1,225.54	XRH500 £1,409.38
H133A Left Hand or Right Hand	240mm x 165mm x 425mm	RH133A54 £619.77	XRH133A54 £729.15

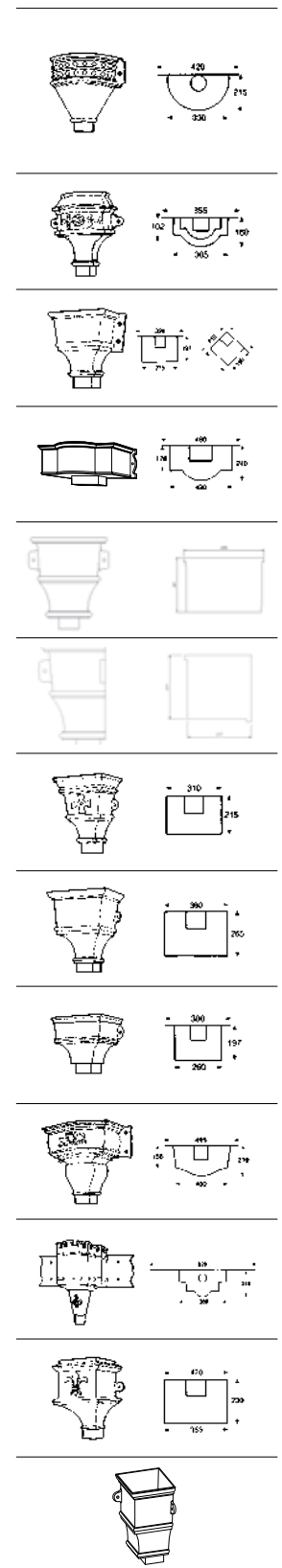

Heads are supplied with embellishments as shown and can be customised on request. Please check suitability of required outlet. Other colours available on request – POA.



Products can be supplied in any RAL or BS colour.
We can also colour match from customer supplied samples.
Price on application.

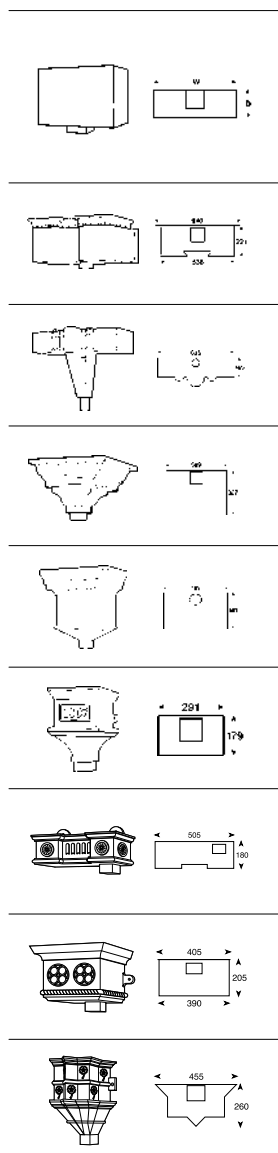

ORNAMENTAL HEADS			
Description	Width x Depth x Height	Premier [Primed]	Premier Extra [Black]
H501	200mm x 150mm x 370mm	RH501 £456.48	XRH501 £524.89
H501L Long	450mm x 150mm x 370mm	RH501L £782.94	XRH501L £900.39
H510	640mm x 221mm x 243mm	RH510 £1,270.50	XRH510 £1,461.06
H511	635mm x 160mm x 510mm	RH511 £1,396.45	XRH511 £1,605.91
H513	508mm x 367mm x 340mm	RH513 £1,340.41	XRH513 £1,541.47
H514	785mm x 505mm x 582mm	RH514 £1,408.23	XRH514 £1,619.46
H515	291mm x 179mm x 429mm	RH515 £1,149.42	XRH515 £1,321.83
H516	505mm x 180mm x 167mm	RH516 £1,086.67	XRH516 £1,249.62
H517	405mm x 205mm x 280mm	RH517 £987.94	XRH517 £1,136.12
H518	455mm x 260mm x 530mm	RH518 £1,147.55	XRH518 £1,319.66

Heads are supplied with embellishments as shown and can be customised on request. Please check suitability of required outlet. Other colours available on request – POA.



Products can be supplied in any RAL or BS colour.
We can also colour match from customer supplied samples.
Price on application.

ORNAMENTAL HEADS			
Description	Width x Depth x Height	Premier [Primed]	Premier Extra [Black]
H519	340mm x 190mm x 325mm	RH519 £899.27	XRH519 £1,034.16
H521 Flat Back	430mm x 185mm x 370mm	RH521 £952.28	XRH521 £1,095.16
H522	445mm x 235mm x 168mm	RH522 £811.56	XRH522 £933.31
H523	760mm x 225mm x 210mm	RH523 £1,301.66	XRH523 £1,496.92
H524	305mm x 210mm x 445mm	RH524 £1,462.29	XRH524 £1,681.65
H525	270mm x 208mm x 285mm	RH525 £931.55	XRH525 £1,071.33
H526	440mm x 240mm x 460mm	RH526 £1,210.32	XRH526 £1,391.87
H527	430mm x 195mm x 540mm	RH527 £1,546.52	XRH527 £1,778.49
H528	760mm x 370mm x 565mm	RH528 £1,255.98	XRH528 £1,444.39

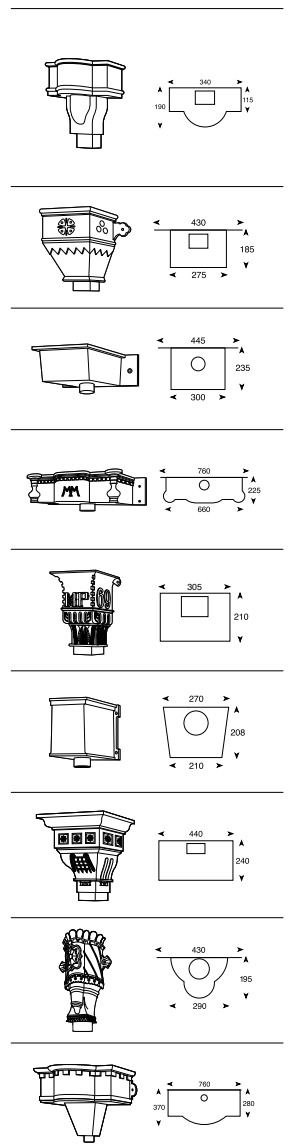

Heads are supplied with embellishments as shown and can be customised on request. Please check suitability of required outlet. Other colours available on request – POA.



Products can be supplied in any RAL or BS colour.
We can also colour match from customer supplied samples.
Price on application.

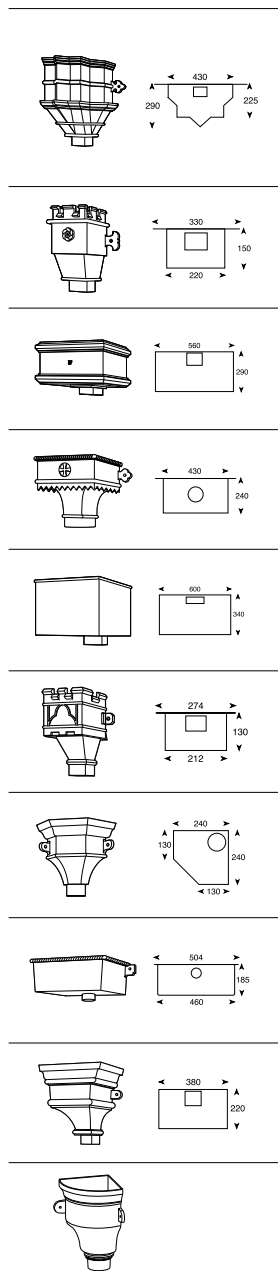

ORNAMENTAL HEADS			
Description	Width x Depth x Height	Premier [Primed]	Premier Extra [Black]
H529	430mm x 290mm x 540mm	RH529 £1,514.65	XRH529 £1,741.87
H530	330mm x 150mm x 350mm	RH530 £1,041.27	XRH530 £1,197.45
H532	560mm x 290mm x 305mm	RH532 £1,300.05	XRH532 £1,495.08
H534	430mm x 240mm x 366mm	RH534 £1,464.82	XRH534 £1,684.53
H540	600mm x 340mm x 475mm	RH540 £1,210.32	XRH540 £1,391.87
H541	274mm x 130mm x 330mm	RH541 £718.28	XRH541 £817.29
H542A Corner	240mm x 240mm x 290mm	RH542A £677.81	XRH542A £779.47
H543	504mm x 185mm x 200mm	RH543 £796.43	XRH543 £915.92
H544	380mm x 220mm x 418mm	RH544 £1,301.19	XRH544 £1,496.40
H546	235mm x 235mm x 409mm	RH546 £705.09	XRH546 £810.84

Heads are supplied with embellishments as shown and can be customised on request. Please check suitability of required outlet. Other colours available on request – POA.



Products can be supplied in any RAL or BS colour.
We can also colour match from customer supplied samples.
Price on application.



Hargreaves Premier LCC Soil is a traditional socket and spigot pipe system with fittings for above ground soil and waste. Most products are ex stock but other items are available as bespoke.

Traditional LCC Soil (BS 416) is coated in a Bitumen paint and is not available in other colours/finishes.

BS 416 PREMIER LCC SOIL



SOIL PIPES & FITTINGS

66-69

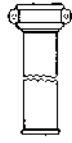

EARED PIPES						
Premier [BS416]						
Description	50mm [2"]	65mm [2.5"]	75mm [3"]	90mm [3.5"]	100mm [4"]	150mm [6"]
1829mm [6FT] Eared	S2001E £137.00	S2501E £147.45	S3001E £147.45	S3501E £184.76	S4001E £184.76	S6001E £373.97
1219mm [4FT] Eared	S2004E £128.56	S2504E £140.35	S3004E £140.35	S3504E £172.59	S4004E £172.59	S6004E £332.79
914mm [3FT] Eared	S2003E £111.01	S2503E £119.41	S3003E £119.41	S3503E £149.36	S4003E £149.36	S6003E £310.57
610mm [2FT] Eared	S2002E £111.01	S2502E £119.41	S3002E £119.41	S3502E £149.36	S4002E £149.36	S6002E £310.57
1829mm [6FT] Double Socket Eared	S2001DE £181.62	S2501DE £189.40	S3001DE £189.40	S3501DE £247.29	S4001DE £247.29	S6001DE £509.12
PLAIN PIPES						
Premier [BS416]						
Description	50mm [2"]	65mm [2.5"]	75mm [3"]	90mm [3.5"]	100mm [4"]	150mm [6"]
1829mm [6FT] Plain	S2001 £129.70	S2501 £139.49	S3001 £139.49	S3501 £176.79	S4001 £176.79	S6001 £339.69
1219mm [4FT] Plain	S2004 £107.12	S2504 £114.35	S3004 £114.35	S3504 £141.53	S4004 £141.53	S6004 £296.27
914mm [3FT] Plain	S2003 £86.01	S2503 £91.69	S3003 £91.69	S3503 £113.29	S4003 £113.29	S6003 £267.94
610mm [2FT] Plain	S2002 £86.01	S2502 £91.69	S3002 £91.69	S3502 £113.29	S4002 £113.29	S6002 £267.94
1829mm [6FT] Double Socket Plain	S2001D £179.88	S2501D £185.35	S3001D £185.35	S3501D £220.72	S4001D £220.72	S6001D £441.01
ACCESS PIPE						
Premier [BS416]						
Description	50mm [2"]	65mm [2.5"]	75mm [3"]	90mm [3.5"]	100mm [4"]	150mm [6"]
Oval Door	S2010 £136.47	S2510 £136.47	S3010 £136.47	S3510 £148.93	S4010 £148.93	S6010 £241.66
BENDS						
Premier [BS416]						
Description	50mm [2"]	65mm [2.5"]	75mm [3"]	90mm [3.5"]	100mm [4"]	150mm [6"]
92.5°	S2020 £64.82	S2520 £78.45	S3020 £78.45	S3520 £96.34	S4020 £96.34	S6020 £161.03
112.5°	S2021 £64.82	S2521 £78.45	S3021 £78.45	S3521 £96.34	S4021 £96.34	S6021 £161.03
135°	S2022 £64.82	S2522 £78.45	S3022 £78.45	S3522 £96.34	S4022 £96.34	S6022 £161.03
with Door 92.5°	S2020D £160.52	S2520D £174.03	S3020D £174.03	S3520D £197.79	S4020D £197.79	S6020D £263.50
with Door 112.5°	S2021D £160.52	S2521D £174.03	S3021D £174.03	S3521D £197.79	S4021D £197.79	S6021D £263.50
with Door 135°	S2022D £160.52	S2522D £174.03	S3022D £174.03	S3522D £197.79	S4022D £197.79	S6022D £263.50
EXPANDING PIECES						
Premier [BS416]						
Description	50mm [2"]	65mm [2.5"]	75mm [3"]	90mm [3.5"]	100mm [4"]	150mm [6"]
75mm x 50mm [3" x 2"] Spigot Large End			S3052 £82.20			
100mm x 50mm [4" x 2"] Spigot Large End					S4052 £114.74	
100mm x 75mm [4" x 3"] Spigot Large End					S4053 £114.74	
150mm x 100mm [6" x 4"] Spigot Large End						S6052 £234.67
DIMINISHING PIECES						
Premier [BS416]						
Description	50mm [2"]	65mm [2.5"]	75mm [3"]	90mm [3.5"]	100mm [4"]	150mm [6"]
75mm x 65mm [3" x 2.5"] Spigot Small End			S3054 £114.74			
90mm x 65mm [3.5" x 2.5"] Spigot Small End				S3554 £141.46		
100mm x 90mm [4" x 3.5"] Spigot Small End					S4054 £141.46	

Ears can be fitted to any item on request – POA.

LOOSE SOCKETS

Premier [BS416]						
Description	50mm [2"]	65mm [2.5"]	75mm [3"]	90mm [3.5"]	100mm [4"]	150mm [6"]
Eared	S2050E £40.78	S2550E £43.03	S3050E £43.03	S3550E £48.45	S4050E £48.45	S6050E £91.30
Plain	S2050 £36.35	S2550 £38.36	S3050 £38.36	S3550 £40.57	S4050 £40.57	S6050 £55.29



OFFSETS

Premier [BS416]						
Description	50mm [2"]	65mm [2.5"]	75mm [3"]	90mm [3.5"]	100mm [4"]	150mm [6"]
75mm [3"] Projection	S2040 £86.26	S2540 £91.00	S3040 £91.00	S3540 £133.06	S4040 £133.06	S6040 £234.22
115mm [4.5"] Projection	S2041 £86.26	S2541 £91.00	S3041 £91.00	S3541 £133.06	S4041 £133.06	S6041 £234.22
150mm [6"] Projection	S2042 £86.26	S2542 £91.00	S3042 £91.00	S3542 £133.06	S4042 £133.06	S6042 £234.22
230mm [9"] Projection	S2043 £99.13	S2543 £104.58	S3043 £104.58	S3543 £147.64	S4043 £147.64	S6043 £267.60
305mm [12"] Projection	S2044 £111.00	S2544 £117.11	S3044 £117.11	S3544 £165.38	S4044 £165.38	S6044 £301.18
380mm [15"] Projection	S2045 £149.98	S2545 £158.23	S3045 £158.23	S3545 £240.79	S4045 £240.79	S6045 £381.93
457mm [18"] Projection	S2046 £179.74	S2546 £189.64	S3046 £189.64	S3546 £278.73	S4046 £278.73	S6046 £394.38
533mm [21"] Projection	S2047 £209.55	S2547 £221.07	S3047 £221.07	S3547 £334.49	S4047 £334.49	S6047 £407.43
610mm [24"] Projection	S2048 £231.29	S2548 £244.01	S3048 £244.01	S3548 £369.16	S4048 £369.16	S6048 £476.46

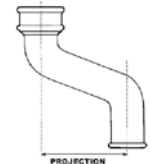

EQUAL BRANCHES

Premier [BS416]						
Description	50mm [2"]	65mm [2.5"]	75mm [3"]	90mm [3.5"]	100mm [4"]	150mm [6"]
92.5°	S2030 £96.96	S2530 £105.09	S3030 £105.09	S3530 £154.70	S4030 £163.20	S6030 £267.31
112.5°	S2031 £96.96	S2531 £105.09	S3031 £105.09	S3531 £154.70	S4031 £163.20	S6031 £267.31
135°	S2032 £96.96	S2532 £105.09	S3032 £105.09	S3532 £154.70	S4032 £163.20	S6032 £267.31
92.5° with Door	S2030D £189.20	S2530D £197.35	S3030D £197.35	S3530D £233.71	S4030D £246.56	S6030D £362.93
112.5° with Door	S2031D £189.20	S2531D £197.35	S3031D £197.35	S3531D £233.71	S4031D £246.56	S6031D £362.93
135° with Door	S2032D £189.20	S2532D £197.35	S3032D £197.35	S3532D £233.71	S4032D £246.56	S6032D £362.93
92.5° Double	S2056 £198.67	S2556 £209.59	S3056 £209.59	S3556 £259.92	S4056 £274.23	S6056 £462.36
112.5° Double	S2056B £198.67	S2556B £209.59	S3056B £209.59	S3556B £259.92	S4056B £274.23	S6056B £462.36
135° Double	S2056C £198.67	S2556C £209.59	S3056C £209.59	S3556C £259.92	S4056C £274.23	S6056C £462.36



UNEQUAL BRANCHES

Premier [BS416]						
Description	50mm [2"]	65mm [2.5"]	75mm [3"]	90mm [3.5"]	100mm [4"]	150mm [6"]
Unequal Available in 92.5°, 112.5°, or 135°		£89.07	£89.07	£126.76	£126.76	£126.76
Unequal with Door Available in 92.5°, 112.5°, or 135°		£167.24	£167.24	£208.96	£208.96	£307.57
Double Unequal Available in 92.5°, 112.5°, or 135°		£177.62	£177.62	£220.27	£232.40	£391.83



Due to the many possibilities in the Unequal Branches, please contact HF sales office for ordering codes. Ears can be fitted to any item on request – POA. Please check code for specific unequal branch.



P TRAP						
Premier [BS416]						
Description	50mm [2"]	65mm [2.5"]	75mm [3"]	90mm [3.5"]	100mm [4"]	150mm [6"]
P Trap			S3096 £124.66	S3596 £151.36	S4096 £151.36	S6096 £355.90



SHOES						
Premier [BS416]						
Description	50mm [2"]	65mm [2.5"]	75mm [3"]	90mm [3.5"]	100mm [4"]	150mm [6"]
Eared	S2051E £81.24	S2551E £85.71	S3051E £85.71	S3551E £112.20	S4051E £112.20	S6051E £229.35
Plain	S2051 £73.58	S2551 £77.61	S3051 £77.61	S3551 £104.62	S4051 £104.62	S6051 £193.25

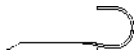

HOLDFAST						
Premier [BS416]						
Description	50mm [2"]	65mm [2.5"]	75mm [3"]	90mm [3.5"]	100mm [4"]	150mm [6"]
Holdfast	S2058 £8.50	S2558 £9.06	S3058 £9.06	S3558 £11.61	S4058 £11.61	S6058 £23.82



HOLDERBATS						
Premier [BS416]						
Description	50mm [2"]	65mm [2.5"]	75mm [3"]	90mm [3.5"]	100mm [4"]	150mm [6"]
Screw to Wall (Hinged)	S2060 £53.04	S2560 £55.96	S3060 £55.96	S3560 £62.52	S4060 £62.52	S6060 £145.78
Steel Screw to Wall (Bolted)	S2064 £50.85	S2564 £55.96	S3064 £55.96	S3564 £62.52	S4064 £58.42	S6064 £145.78
Build-In	S2061 £45.34	S2561 £47.85	S3061 £47.85	S3561 £52.79	S4061 £52.79	



BOSSED PIPES						
Premier [BS416]						
Description	50mm [2"]	65mm [2.5"]	75mm [3"]	90mm [3.5"]	100mm [4"]	150mm [6"]
610mm [24"] Overall: 1.25"	S2081 £185.08				S4081 £203.15	
610mm [24"] Overall: 1.5"			S3082 £189.65		S4082 £203.15	
610mm [24"] Overall: 2"	S2083 £185.08		S3083 £189.65		S4083 £203.15	
Extra Boss					S4084 £53.44	



STRAP ON BOSS						
Premier [BS416]						
Description	50mm [2"]	65mm [2.5"]	75mm [3"]	90mm [3.5"]	100mm [4"]	150mm [6"]
2" Bspt					S4092 £98.04	



BLANK END						
Premier [BS416]						
Description	50mm [2"]	65mm [2.5"]	75mm [3"]	90mm [3.5"]	100mm [4"]	150mm [6"]
Blank End	S2070 £30.00	S2570 £31.67	S3070 £31.67	S3570 £39.73	S4070 £39.73	S6070 £79.46



SOCKET REDUCERS						
Premier [BS416]						
Description	50mm [2"]	65mm [2.5"]	75mm [3"]	90mm [3.5"]	100mm [4"]	150mm [6"]
75mm x 50mm [3" x 2"]			S3086 £30.37			
100mm x 50mm [4" x 2"]					S4086 £39.73	
100mm x 75mm [4" x 3"]					S4087 £39.73	



EARS						
Premier [BS416]						
Description	50mm [2"]	65mm [2.5"]	75mm [3"]	90mm [3.5"]	100mm [4"]	150mm [6"]
Loose Ears	S2065 £31.52	S2565 £33.24	S3065 £33.26	S3565 £38.05	S4065 £38.05	S6065 £49.03

Ears can be fitted to any item on request - POA.

ORNAMENTAL EARBANDS						
Premier [BS416]						
Description	50mm [2"]	65mm [2.5"]	75mm [3"]	90mm [3.5"]	100mm [4"]	150mm [6"]
Ornamental Type A	S20620A £123.17	S25620A £129.95	S30620A £129.95	S35620A £135.20	S40620A £135.20	S60620A
Ornamental Type B	S20620B £123.17	S25620B £129.95	S30620B £129.95	S35620B £135.20	S40620B £135.20	S60620B £168.55
Ornamental Type C	S20620C £123.17	S25620C £129.95	S30620C £129.95	S35620C £135.20	S40620C £135.20	S60620C £168.55
Ornamental Type D	S20620D £123.17	S25620D £129.95	S30620D £129.95	S35620D £135.20	S40620D £135.20	S60620D £168.55
Ornamental Type E	S20620E £123.17	S25620E £129.95	S30620E £129.95	S35620E £135.20	S40620E £135.20	S60620E £168.55
Ornamental Type F	S20620F £123.17	S25620F £129.95	S30620F £129.95	S35620F £135.20	S40620F £135.20	S60620F £168.55
Ornamental Type G	S20620G £123.17	S25620G £129.95	S30620G £129.95	S35620G £135.20	S40620G £135.20	S60620G £168.55
Ornamental Type J	S20620J £123.17	S25620J £129.95	S30620J £129.95	S35620J £135.20	S40620J £135.20	S60620J £168.55
Ornamental Type K	S20620K £123.17	S25620K £129.95	S30620K £129.95	S35620K £135.20	S40620K £135.20	S60620K £168.55

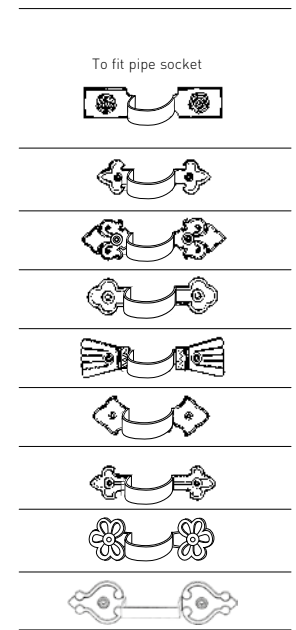



LCC SOIL SUNDRIES



LOOSE DOOR & GASKET						
Premier [BS416]						
Description	50mm [2"]	65mm [2.5"]	75mm [3"]	90mm [3.5"]	100mm [4"]	150mm [6"]
Loose Door	S2069 £22.44	S2569 £24.00	S3069 £24.00	S3569 £26.14	S4069 £26.14	S6069 £40.94
Rubber Gasket	S2069G £6.98	S2569G £9.81	S3069G £9.81	S3569G £13.69	S4069G £13.69	S6069G £24.75
COWL						
Premier [BS416]						
Description	50mm [2"]	65mm [2.5"]	75mm [3"]	90mm [3.5"]	100mm [4"]	150mm [6"]
100mm [4"] To Fit Pipe Barrel					S4055 £77.00	
WIRE BALLOON						
Premier [BS416]						
Description	50mm [2"]	65mm [2.5"]	75mm [3"]	90mm [3.5"]	100mm [4"]	150mm [6"]
Wire Balloon	S2080 £14.80	S2580 £15.63	S3080 £15.63	S3580 £16.65	S4080 £16.65	S6080 £34.99
WOODEN BOBBIN						
Description						
30mm Projection	R0001 £2.63					
PIPE NAILS						
Description						
75mm [3"] to Suit all Pipe Sizes	R0003 £0.89					
100mm [4"] to Suit all Pipe Sizes	R0004 £0.98					
SET SCREWS						
Description						
Per Pair [To Fit Loose Door]	S0002 £3.69					
CAULKING CORD						
Description						
Per Metre - [Approximately 4m required for 4" Joint]	S0006 £0.46					
JOINT SEALANT						
Description						
290ml Cartridge [Black] [1 required for approximately 4 Joints]	S0007 £25.93					

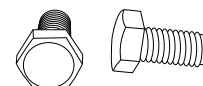
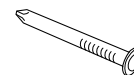

Installation instructions available on request.

Traditional Express (TX) is a push fit soil system designed for a lifetime performance. This contemporary Cast Iron system has the appearance of traditional Cast Iron soil drainage but requires no caulking or sealing. It is quicker to fit saving significant time on every joint. The sockets are manufactured to fit 50mm and 100mm pipes and fittings.

All push fit sockets are supplied with EPDM rubber sealing rings which are suitable for most applications. Where especially aggressive substances need to be discharged please check with our technical department as to their suitability.

TRADITIONAL EXPRESS SOIL



COATINGS

All pipes and fittings are factory coated with a two pack black gloss paint finish as standard, suitable for internal and external installations. All the pipes have an epoxy yellow internal coating. Traditional Express pipes and fittings can also be supplied in colours from the RAL range and also with our Coastal paint finish for marine environments.

Installation guidance is provided on instructions included with delivery and at www.hargreavesfoundry.co.uk

PIPES & SOCKETS, BENDS

73

BRANCHES

74

FITTINGS

75

BRACKETS & SUNDRIES

76

DOUBLE SPIGOT PIPES

Product Code	Diameter [mm]	Length[m]	Price
TX2001	50	3	£149.37
TX2001A	50	1.5	£84.18
TX4001	100	3	£206.00
TX4001A	100	1.8	£123.64

PUSH FIT SOCKETS

Product Code	Diameter [mm]	Type	Price
TX2016	50	Plain	£40.77
TX2016E	50	Eared	£42.68
TX4016	100	Plain	£48.86
TX4016E	100	Eared	£52.52

PUSH FIT SLIP SOCKET

Product Code	Diameter [mm]	Type	Price
TX4016SE	100	Eared	£63.05

DUCTILE IRON COUPLING

Product Code	Diameter [mm]	Price
TX2012	50	£31.12
TX4012	100	£37.28

SHORT RADIUS BENDS

Product Code	Diameter [mm]	Angle	Price
TX2003	50	87.5°	£44.46
TX2005	50	45°	£44.46
TX4003M	100	87.5°	£64.69
TX4004M	100	67.5°	£64.69
TX4005M	100	45°	£64.69

LONG RADIUS BENDS

Product Code	Diameter [mm]	Angle	Price
TX4008	100	87.5°	£104.72
TX4009	100	22°	£104.72

SHORT RADIUS BENDS WITH DOOR

Product Code	Diameter [mm]	Angle	Price
TX4010M	100	87.5°	£133.87

LONG RADIUS BENDS WITH DOOR

Product Code	Diameter [mm]	Angle	Price
TX4011	100	87.5°	£177.01

LONG TAIL BEND

Product Code	Diameter [mm]	Angle	Price
TX4013	100	87.5°	£82.79

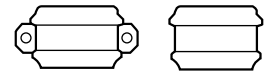
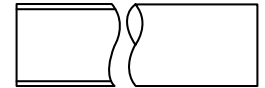

Supplied with gaskets

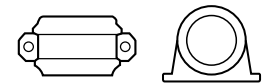

Supplied with gaskets

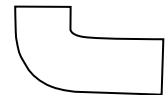
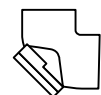
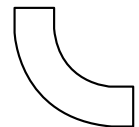
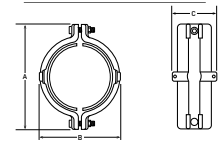

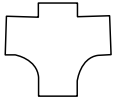
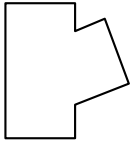
**SINGLE BRANCHES**

Product Code	Diameter [mm]	Angle	Price
TX2020	50	87.5°	£67.14
TX2026	50	45°	£67.14
TX4020	100 x 50	87.5°	£99.28
TX4025	100 x 100	67.5°	£99.28
TX4026	100 x 50	45°	£99.28
TX4028	100 x 100	45°	£99.28

SINGLE RADIUS CURVE BRANCH

Product Code	Diameter [mm]	Angle	Price
TX4030	100 x 100	87.5°	£99.28

SINGLE RADIUS CURVE BRANCH WITH DOOR

Product Code	Diameter [mm]	Angle	Price
TX4032	100 x 100	1.2	£169.77

DOUBLE RADIUS CURVE BRANCH

Product Code	Diameter [mm]	Angle	Price
TX4038	100 x 100	87.5°	£124.61

SINGLE RADIUS CURVE BRANCH WITH 2" BSPT BOSS ON BACK

Product Code	Diameter [mm]	Angle	Price
TX4039B	100 x 100	87.5°	£136.40

SINGLE RADIUS CURVE BRANCH WITH 2" BSPT BOSS ON LEFT

Product Code	Diameter [mm]	Angle	Price
TX4039L	100	87.5°	£136.40

SINGLE RADIUS CURVE BRANCH WITH 2" BSPT BOSS ON RIGHT

Product Code	Diameter [mm]	Angle	Price
TX4039R	100	87.5°	£136.40



TECHNICAL
SUPPORT

If you need any assistance of a technical nature,
please feel free to give us a call.



SITE
SURVEYS

If you need us to visit a site, we're happy to oblige.
We can assist with working out quantities required
or any unusual requirements.

ACCESS PIPE WITH ROUND DOOR			
Product Code	Diameter [mm]	Price	
TX2043	50	£105.21	
TX4043	100	£117.83	
ACCESS PIPE WITH RECTANGULAR DOOR			
Product Code	Diameter [mm]	Price	
TX4049	100	£181.99	
OFFSETS			
Product Code	Diameter [mm]	Projection [mm]	Price
TX4044	100	75	£68.43
TX4045	100	130	£91.21
TX4085	100	300	£104.90
BOSS PIPE SINGLE 2" BSPT			
Product Code	Diameter [mm]	Price	
TX4053	100	£116.02	
BOSS PIPE DOUBLE 2" BSPT OPPOSED			
Product Code	Diameter [mm]	Price	
TX4054	100	£149.93	
BOSS PIPE DOUBLE 2" BSPT AT 90°			
Product Code	Diameter [mm]	Price	
TX4055	100	£149.93	
STRAP ON BOSS 2" BSPT			
Product Code	Diameter [mm]	Price	
TX4092	100 x 100	£95.52	
BLANK END			
Product Code	Diameter [mm]	Price	
TX2051	50	£16.05	
TX4051	100	£19.73	
BLANK END DRILLED & TAPPED 2" BSPT			
Product Code	Diameter [mm]	Price	
TX4052	100	£42.86	
COWL			
Product Code	Diameter [mm]	Price	
TX4056	100	£79.52	
PIPE TAPER			
Product Code	Diameter [mm]	Price	
TX4046	100 x 50	£79.05	

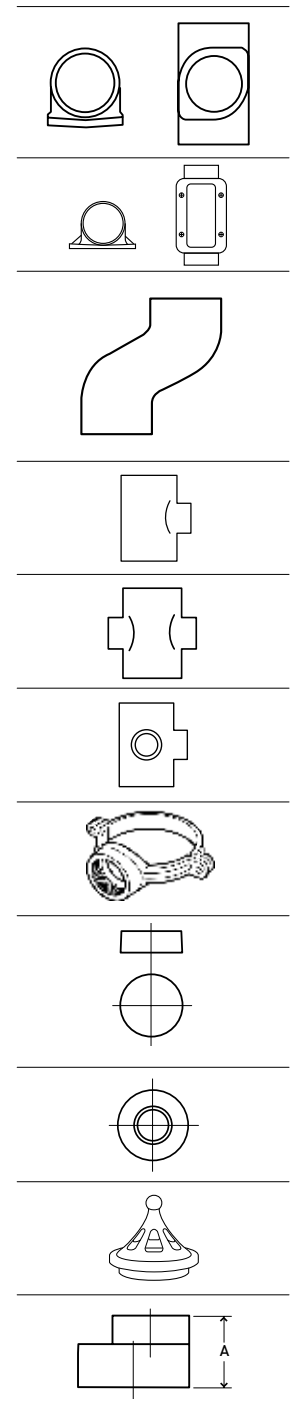

If you don't see a product within this brochure, we have the knowledge, experience and capability to manufacture bespoke castings and fabricated products to support our comprehensive standard ranges.

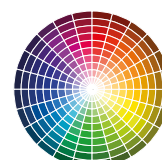

Products can be supplied in any RAL or BS colour. We can also colour match from customer supplied samples. Price on application.

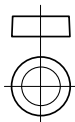
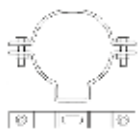
**COATED ADJUSTABLE BRACKETS**

Product Code	Diameter [mm]	Price
TX2067	50	£18.01
TX4067	100	£19.38

GASKET LUBRICANT

Product Code	Size	Price
TX0001	250ml Tube	£16.00

GASKET RELAXING TOOL

Product Code	Diameter [mm]	Price
TX0002	100	£26.67
TX0003	50	£26.67



TECHNICAL
SUPPORT

If you need any assistance of a technical nature,
please feel free to give us a call.



SITE
SURVEYS

If you need us to visit a site, we're happy to oblige.
We can assist with working out quantities required
or any unusual requirements.



Mech 416 Soil is a mechanically jointed range of pipes and fittings in 50mm to 150mm diameter. They are suitable for above ground soil and waste systems.

Mech 416 ductile Cast Iron couplings are manufactured in accordance with BS EN 1563, ISO 1083 with minimum strength of 420N/mm².

All couplings are supplied with EPDM rubber sealing rings which are suitable for most applications. Where especially aggressive waste liquids are to be discharged please check with our technical department.

Installation guidance is available at www.hargreavesfoundry.co.uk

MECH 416 SOIL



COATINGS

Pipes

External: One part epoxy coating in matt black.

Internal: Two part epoxy coating yellow.

Fittings

Internal and external one part epoxy matt black.

PIPES & COUPLINGS

78

BENDS

79-80

BRANCHES

81-82

OTHER FITTINGS

83-84

BRACKETS & SUNDRIES

85

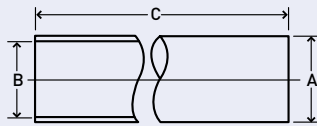
**DOUBLE SPIGOT PIPES**

Product Code	Diameter [mm]	Max. Overall Dia. A [mm]	Max. Overall Dia. B [mm]	Max. Overall Dia. C [mm]	Nominal Weight [kg]	Price
MS2001	50	60	47.5	3000	15.7	£128.50
MS3001	70	80	68.25	3000	19.4	£141.30
MS4001	100	112	97.5	3000	29.7	£174.79
MS6001	150	162	146.25	3000	45.2	£344.08

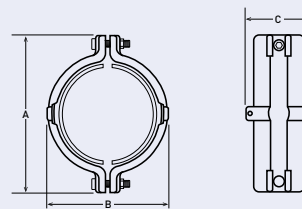
**DUCTILE IRON COUPLINGS**

Product Code	Diameter [mm]	A [mm]	B [mm]	C [mm]	Nominal Weight [kg]	Price
MS2012	50	117	79	69	0.7	£22.00
MS3012	70	137	100	73	0.8	£24.24
MS4012	100	172	132	73	1.1	£31.34
MS6012	150	223	180	95	2	£63.11

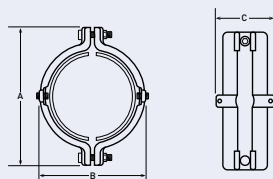

Supplied with grub screws for continuity.

DUCTILE IRON COUPLINGS WITH CONTINUITY

Product Code	Diameter [mm]	"A [mm]" [mm]	"B [mm]" [mm]	"C [mm]" [mm]	Nominal Weight [kg]	Price
MS2012C	50	117	79	69	0.7	£24.25
MS3012C	70	137	100	73	0.8	£26.47
MS4012C	100	172	132	73	1.1	£33.59
MS6012C	150	223	180	95	2	£65.35

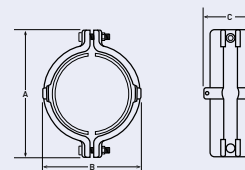
**CONVERSION - MECH 416 TO LCC SOIL**

Product Code	Mech 416 Diameter [mm]	LCC Diameter [mm]	A [mm]	B [mm]	C [mm]	Nominal Weight [kg]	Price
MS3018	70	65	137	100	73	0.9	£31.76
MS4017	100	90	172	132	73	1.2	£40.72

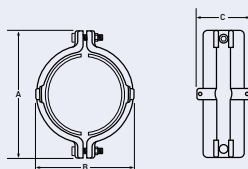
**"CONVERSION COUPLING - MECH 416 TO ALTERNATIVELY SIZED EQUIVALENT SYSTEMS"**

Product Code	Mech 416 Diameter [mm]	Alternative Diameter [mm]	A [mm]	B [mm]	C [mm]	Nominal Weight [kg]	Price
MS3019	70	75	142	105	73	1	£27.62



If you need any assistance of a technical nature, please feel free to give us a call.



SITE SURVEYS

If you need us to visit a site, we're happy to oblige. We can assist with working out quantities required or any unusual requirements.

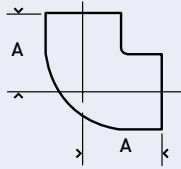

87.5° SHORT RADIUS BENDS

Product Code	Diameter [mm]	A [mm]	Nominal Weight [kg]	Price
MS2003	50	75	0.8	£35.58
MS3003	70	90	1.3	£37.30
MS4003M	100	145	2.5	£54.87
MS6003	150	145	5.1	£96.50

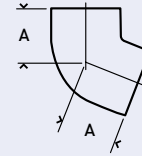

67.5° SHORT RADIUS BENDS

Product Code	Diameter [mm]	A [mm]	Nominal Weight [kg]	Price
MS4004M	100	135	3	£54.87

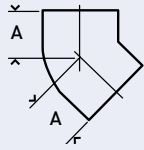

45° SHORT RADIUS BENDS

Product Code	Diameter [mm]	A [mm]	Nominal Weight [kg]	Price
MS2005	50	50	0.6	£35.58
MS3005	70	60	0.9	£37.30
MS4005M	100	135	2.7	£54.87
MS6005	150	90	3.6	£96.50

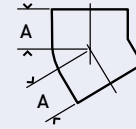

30° SHORT RADIUS BENDS

Product Code	Diameter [mm]	A [mm]	Nominal Weight [kg]	Price
MS4006	100	60	1.4	£46.31

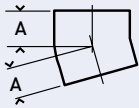

15° SHORT RADIUS BENDS

Product Code	Diameter [mm]	A [mm]	Nominal Weight [kg]	Price
MS4007	100	50	0.6	£46.31

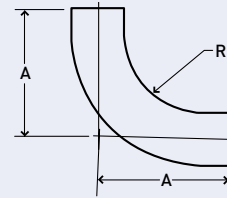

87.5° LONG RADIUS BENDS

Product Code	Diameter [mm]	A [mm]	R [mm]	Nominal Weight [kg]	Price
MS4008	100	269	180	5.3	£92.91
MS6008	150	274	150	10.7	£222.93

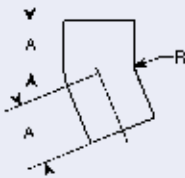

22.5° LONG RADIUS BENDS

Product Code	Diameter [mm]	A [mm]	R [mm]	Nominal Weight [kg]	Price
MS4009	100	90	180	2.2	£86.48



SPECIAL BESPOKE CASTINGS

If you don't see a product within this brochure, we have the knowledge, experience and capability to manufacture bespoke castings and fabricated products to support our comprehensive standard ranges.

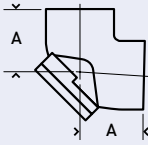
**87.5° SHORT RADIUS BENDS WITH DOOR**

Product Code	Diameter [mm]	A [mm]	Nominal Weight [kg]	Price
MS3010	70	90	2.1	£81.09
MS4010M	100	145	4.1	£114.63

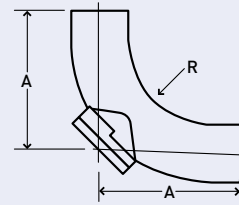
**87.5° LONG RADIUS BENDS WITH DOOR**

Product Code	Diameter [mm]	A [mm]	R [mm]	Nominal Weight [kg]	Price
MS4011	100	269	125	7.3	£148.10
MS6011	150	274	150	12.7	£280.45

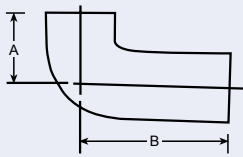
**87.5° LONG TAIL END**

Product Code	Diameter [mm]	A [mm]	R [mm]	Nominal Weight [kg]	Price
MS4013	100	110	250	4	£72.59



TECHNICAL
SUPPORT

If you need any assistance of a technical nature,
please feel free to give us a call.



SITE
SURVEYS

If you need us to visit a site, we're happy to oblige.
We can assist with working out quantities required
or any unusual requirements.

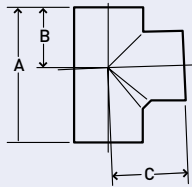

87.5° SINGLE EQUAL BRANCHES

Product Code	Diameter [mm]	A [mm]	B [mm]	C [mm]	Nominal Weight [kg]	Price
MS2020	50 x 50	117	66	80	1.1	£56.19
MS3021	70 x 70	137	83	95	1.8	£59.63

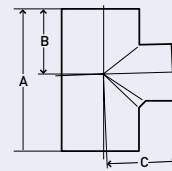

87.5° SINGLE UNEQUAL BRANCHES

Product Code	Diameter [mm]	A [mm]	B [mm]	C [mm]	Nominal Weight [kg]	Price
MS3020	70 x 50	155	72	90	1.5	£59.63
MS4020	100 x 50	170	76	105	2.2	£83.08
MS4021	100 x 70	190	88	110	2.5	£83.08

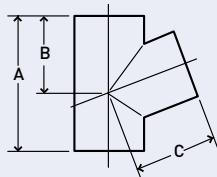

67.5° SINGLE EQUAL BRANCHES

Product Code	Diameter [mm]	A [mm]	B [mm]	C [mm]	Nominal Weight [kg]	Price
MS4025	100 x 100	215	130	130	3.4	£83.08

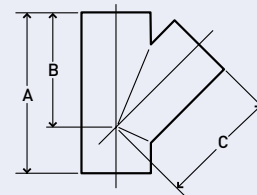

45.5° SINGLE EQUAL BRANCHES

Product Code	Diameter [mm]	A [mm]	B [mm]	C [mm]	Nominal Weight [kg]	Price
MS2026	50 x 50	160	115	120	1.3	£56.19
MS3027	70 x 70	200	145	150	2.2	£59.63
MS4028	100 x 100	260	190	190	4.3	£83.08
MS6027	150 x 150	355	265	265	10.5	£211.53

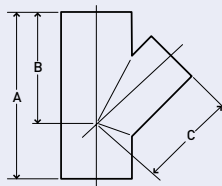

45.5° SINGLE UNEQUAL BRANCHES

Product Code	Diameter [mm]	A [mm]	B [mm]	C [mm]	Nominal Weight [kg]	Price
MS3026	70 x 50	170	130	130	1.8	£59.63
MS4026	100 x 50	180	150	150	2.4	£83.08
MS4027	100 x 70	215	170	170	3.1	£83.08
MS6026	150 x 100	280	225	225	5.8	£165.06

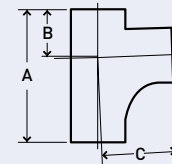

87.5° SINGLE RADIUS CURVE BRANCHES

Product Code	Diameter [mm]	A [mm]	B [mm]	C [mm]	Nominal Weight [kg]	Price
MS4030	100 x 100	260	102	150	4.1	£83.08
MS6030	150 x 100	375	115	202	6.5	£165.06
MS6031	150 x 150	400	135	260	11.7	£211.53

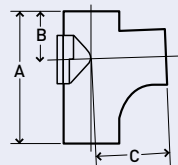

87.5° SINGLE RADIUS CURVE BRANCHES WITH DOOR

Product Code	Diameter [mm]	A [mm]	B [mm]	C [mm]	Nominal Weight [kg]	Price
MS4032	100 x 100	270	102	150	5.4	£142.07
MS6032	150 x 100	300	115	202	9.5	£261.03
MS6033	150 x 150	400	140	260	14.2	£291.46

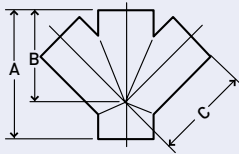
**45° DOUBLE BRANCHES**

Product Code	Diameter [mm]	A [mm]	B [mm]	C [mm]	Nominal Weight [kg]	Price
MS4036	100 x 100	260	190	190	5.7	£104.71
MS6036	150 x 100	280	225	225	6.5	£279.43

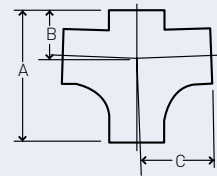
**87.5° DOUBLE RADIUS CURVE BRANCHES**

Product Code	Diameter [mm]	A [mm]	B [mm]	C [mm]	Nominal Weight [kg]	Price
MS4038	100 x 100	270	102	150	5.3	£104.71
MS6038	150 x 100	300	115	200	8.2	£279.43

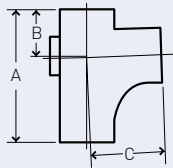
**"87.5° SINGLE RADIUS CURVE BRANCH WITH 2" BSPT BOSS ON BACK"**

Product Code	Diameter [mm]	A [mm]	B [mm]	C [mm]	Nominal Weight [kg]	Price
MS4039B	100 x 100	260	102	150	4.1	£114.14

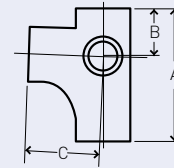
**"87.5° SINGLE RADIUS CURVE BRANCH WITH 2" BSPT BOSS ON LEFT"**

Product Code	Diameter [mm]	A [mm]	B [mm]	C [mm]	Nominal Weight [kg]	Price
MS4039L	100 x 100	270	102	150	5.3	£114.14

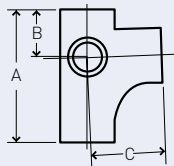
**"87.5° SINGLE RADIUS CURVE BRANCH WITH 2" BSPT BOSS ON RIGHT"**

Product Code	Diameter [mm]	A [mm]	B [mm]	C [mm]	Nominal Weight [kg]	Price
MS4039R	100 x 100	260	190	190	5.7	£114.14

TECHNICAL
SUPPORT

If you need any assistance of a technical nature, please feel free to give us a call.

SITE
SURVEYS

If you need us to visit a site, we're happy to oblige. We can assist with working out quantities required or any unusual requirements.

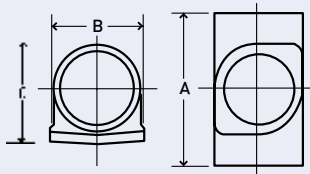

ACCESS PIPES WITH ROUND DOOR

Product Code	Diameter [mm]	A [mm]	B [mm]	C [mm]	Nominal Weight [kg]	Price
MS2043	50	170	80	76	15.7	£88.05
MS3043	70	205	98	92	2.5	£93.67
MS4043	100	250	118	130	4.3	£98.62
MS6043	150	280	172	180	7.9	£163.87

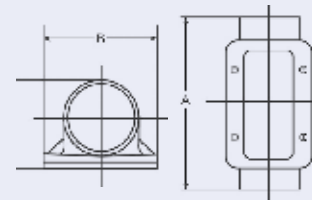

ACCESS PIPES WITH RECTANGULAR DOOR

Product Code	Diameter [mm]	A [mm]	B [mm]	C [mm]	Nominal Weight [kg]	Price
MS4049	100	320	160	129	8	£152.33
MS6049	150	395	215	184	13.5	£283.36

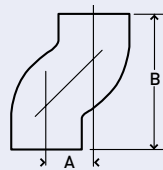

OFFSET 75MM PROJECTION

Product Code	Diameter [mm]	A [mm]	B [mm]	Nominal Weight [kg]	Price
MS4044	100	75	215	2.6	£57.25

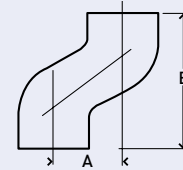

OFFSET 130MM PROJECTION

Product Code	Diameter [mm]	A [mm]	B [mm]	Nominal Weight [kg]	Price
MS2045	50	130	230	1.4	£56.97
MS3045	70	130	250	2.3	£73.54
MS4045	100	130	270	3.8	£79.96

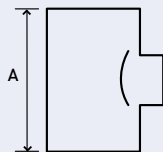

BOSS PIPES SINGLE 2" BSPT

Product Code	Diameter [mm]	A [mm]	Nominal Weight [kg]	Price
MS3053	70	148	1.6	£79.52
MS4053	100	155	2.1	£97.09
MS6053	150	175	3.6	£155.44

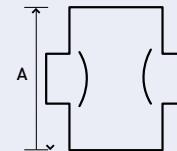

BOSS PIPES DOUBLE 2X2" BSPT OPPOSED

Product Code	Diameter [mm]	A [mm]	R [mm]	Nominal Weight [kg]	Price
MS4054	100	90	180	2.2	£125.50

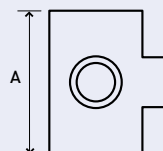

BOSS PIPES DOUBLE 2X2" BSPT AT 90°

Product Code	Diameter [mm]	A [mm]	Nominal Weight [kg]	Price
MS4055	100	155	2.2	£125.50

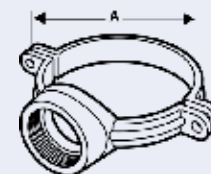

STRAP ON BOSS 2" BSPT

Product Code	Diameter [mm]	Nominal Weight [kg]	Price
MS4092	100	2	£92.11



If you don't see a product within this brochure, we have the knowledge, experience and capability to manufacture bespoke castings and fabricated products to support our comprehensive standard ranges.

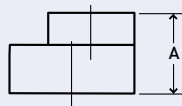

PIPE TAPERS

Product Code	Diameter [mm]	A [mm]	Nominal Weight [kg]	Price
MS3046	70 x 50	78	0.6	£50.99
MS4046	100 x 50	80	0.9	£63.26
MS4047	100 x 70	88	1.1	£63.26
MS6048	150 x 100	102	2.4	£123.58

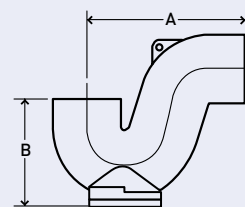

P TRAPS WITH BOTTOM DOOR

Product Code	Diameter [mm]	A [mm]	B [mm]	Nominal Weight [kg]	Price
MS2050	50	160	115	2.3	£130.84
MS3050	70	200	140	3.6	£130.84
MS4050	100	255	175	6.8	£145.07
MS6050	150	350	245	15.8	£253.58

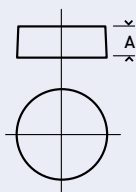

BLANK ENDS

Product Code	Diameter [mm]	A [mm]	Nominal Weight [kg]	Price
MS2051	50	30	0.2	£13.44
MS3051	70	35	0.4	£14.79
MS4051	100	40	0.8	£16.52
MS6051	150	50	1.6	£23.82

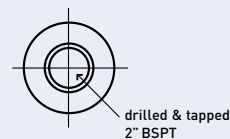

BLANK ENDS DRILLED & TAPPED 2"

Product Code	Diameter [mm]	A [mm]	Nominal Weight [kg]	Price
MS4052	100	40	0.7	£35.85
MS6052	150	50	1.5	£43.88



BELLMOUTH GULLY INLET

Product Code	Diameter [mm]	A [mm]	B [mm]	C [mm]	Nominal Weight [kg]	Price
MS4070	100	215	25	85	2.9	£85.04



SOLID COVER WITH RUBBER SEAL & SCREWS

Product Code	Diameter [mm]	Nominal Weight [kg]	Price
MS8076	200	2.2	£36.50



PLAIN GRATING TO SUIT MS4070

Product Code	Diameter [mm]	Nominal Weight [kg]	Price
MS8077	200	1.8	£18.16

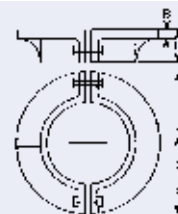

BOLT ON PUDDLE FLANGE

Product Code	Diameter [mm]	A [mm]	B [mm]	C [mm]	Nominal Weight [kg]	Price
MS4078	100	220	12	50	4	£99.52



If you need any assistance of a technical nature, please feel free to give us a call.



SITE SURVEYS

If you need us to visit a site, we're happy to oblige. We can assist with working out quantities required or any unusual requirements.

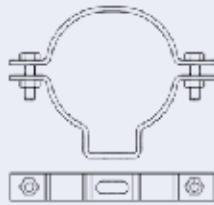

COATED ADJUSTABLE BRACKETS

Product Code	Diameter (mm)	Nominal Weight (kg)	Price
MS2067	50	0.3	£15.80
MS3067	70	0.3	£15.80
MS4067	100	0.6	£17.85
MS6067	150	0.8	£32.59

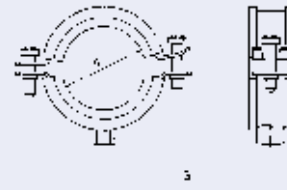

ZINC PLATED RUBBER LINED BISMAT BRACKETS

Product Code	Diameter (mm)	G	Price
HS2061	50	M8/M10	£5.82
HS3061	70	M8/M10	£7.91
HS4061	100	M8/M10	£11.26
HS6061	150	M10	£21.99
HS8061	200	M10	£32.78



ZINC PLATED HEAVY DUTY BOSSED BRACKETS

Product Code	Diameter (mm)	G	Price
HS2063	50	M8/M10	£10.48
HS3063	70	M10/M12	£11.24
HS4063	100	M10/M12	£14.97
HS6063	150	M10/M12	£26.21



ZINC PLATED RUBBER LINED HEAVY DUTY BOSSED BRACKETS

Product Code	Diameter (mm)	G	Price
HS2064	50	M8/M10	£11.24
HS3064	70	M10/M12	£13.75
HS4064	100	M10/M12	£19.96
HS6064	150	M10/M12	£36.65

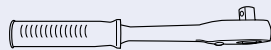

RATCHET SPANNER

Product Code	Price
HSD001	£108.50

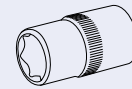

SOCKET (FOR ACCESS DOOR BOLTS)

Product Code	Diameter (mm)	Price
HSD002	13	£19.41



ALLEN SOCKET ADAPTERS (FOR COUPLINGS)

Product Code	Diameter (mm)	Price
HSD003	6	£26.68



If you don't see a product within this brochure, we have the knowledge, experience and capability to manufacture bespoke castings and fabricated products to support our comprehensive standard ranges.

Halifax Soil is a mechanically jointed, socketless system fully compliant with BS EN 877:1999 + A1:2006 Incorporating Corrigendum 2008 and certificated by BSI Kitemark (Cert No. KM 684754) and BBA (Cert No. 06/4401). These products have passed all the initial testing and rigorous on going testing to ensure the BS EN 877 is met. Independent testing is carried out on an annual basis. Our digital catalogue containing all technical, product and installation information is available at www.soilandrain.co.uk

Benefits

- Halifax Soil pipes are durable and will last the life of the building
- Cast Iron is classified as A1 and non combustible, Halifax Soil has a fire rating of A2-s1-d0 which is the best possible rating for systems complying with BS EN 877
- Low noise levels both airborne and structure borne
- Cast Iron is 100% recyclable and a sustainable material

**PUSH FIT
COUPLINGS NOW
AVAILABLE**



EN877 HALIFAX SOIL



Paint Finish

The Halifax Soil system pipes are coated with a two part epoxy finish, red exterior and yellow interior, which provides improved performance when exposed to aggressive substances. The fittings are also epoxy coated in red. The pipes in this system are coated with an average of 40 microns externally and 130 microns internally.

Halifax Soil coatings have been tested successfully for resistance to attack by salt spray, waste water, hot water cycling and solution of acid at PH2 and alkalis at PH12.

SOIL PIPES & COUPLINGS	87
SOIL BENDS	88-89
SOIL BRANCHES	90-91
SOIL FITTINGS	92-93
SOIL BRACKETS & CLAMPS	94-95
SOIL CONNECTORS & TOOLS	96

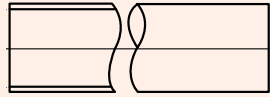

DOUBLE SPIGOT 3M PIPES

Product Code	Diameter (mm)	Nominal Weight (kg)	Price
HS2001	50	15.7	£92.85
HS3001	70	19.4	£106.39
HS4001	100	29.7	£126.28
HS6001	150	45.2	£248.61
HS8001	200	71.2	£416.14

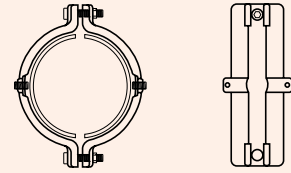

Supplied with grub screws for continuity.

DUCTILE IRON COUPLINGS WITH CONTINUITY

Product Code	Diameter (mm)	Nominal Weight (kg)	Price
HS2012	50	0.7	£14.64
HS3012	70	0.8	£15.97
HS4012	100	1.1	£21.57
HS6012	150	2	£43.29
HS8012	200	3.5	£97.43

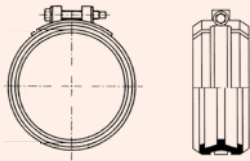

RAPID CONNECT STEEL COUPLING

Product Code	Diameter (mm)	Nominal Weight (kg)	Price
HS2002	50	0.1	£13.54
HS3002	70	0.2	£15.00
HS4002	100	0.2	£18.66
HS6002	150	0.3	£37.49
HS8002	200	0.5	£88.54

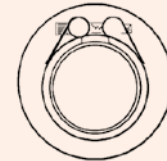

STAINLESS STEEL HIGH PERFORMANCE COUPLINGS

Product Code	Diameter (mm)	Bolt Size	Price
HS2069	50	M8	£253.47
HS3069	70	M10	£264.79
HS4069	100	M10	£277.86
HS6069	150	M12	£466.33
HS8069	200	M16	£662.33

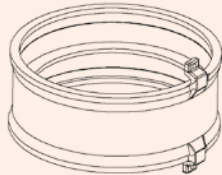

HALIFAX PUSH FIT COUPLINGS

Product Code	Diameter (mm)	Nominal Weight (kg)	Price
HS4095	100	1.5	£20.49
HS6095	150	2	£41.13

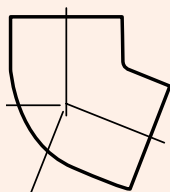
**88° SHORT RADIUS BENDS**

Product Code	Diameter [mm]	Nominal Weight [kg]	Price
HS2003	50	0.8	£24.54
HS3003	70	1.3	£27.76
HS4003	100	2.5	£32.78
HS6003	150	5.1	£59.52
HS8003	200	9	£169.72

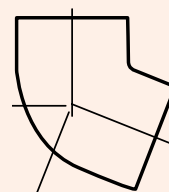
**69° SHORT RADIUS BENDS**

Product Code	Diameter [mm]	Nominal Weight [kg]	Price
HS2004	50	0.8	£24.54
HS3004	70	1.1	£27.76
HS4004	100	2	£32.78
HS6004	150	4.4	£59.52

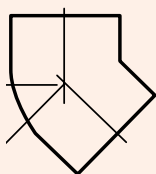
**45° SHORT RADIUS BENDS**

Product Code	Diameter [mm]	Nominal Weight [kg]	Price
HS2005	50	0.6	£24.54
HS3005	70	0.9	£27.76
HS4005	100	1.6	£32.78
HS6005	150	3.6	£59.52
HS8005	200	6.4	£169.72

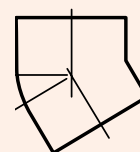
**30° SHORT RADIUS BENDS**

Product Code	Diameter [mm]	Nominal Weight [kg]	Price
HS2006	50	0.5	£24.54
HS3006	70	0.8	£27.76
HS4006	100	1.4	£32.78
HS6006	150	3.2	£59.52

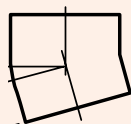
**15° SHORT RADIUS BENDS**

Product Code	Diameter [mm]	Nominal Weight [kg]	Price
HS2007	50	0.4	£24.54
HS3007	70	0.6	£27.76
HS4007	100	1.2	£32.78
HS6007	150	2.5	£59.52



TECHNICAL
SUPPORT

If you need any assistance of a technical nature,
please feel free to give us a call.



SITE
SURVEYS

If you need us to visit a site, we're happy to oblige.
We can assist with working out quantities required
or any unusual requirements.

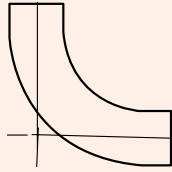

88° LONG RADIUS BENDS

Product Code	Diameter (mm)	Nominal Weight (kg)	Price
HS4008	100	5.3	£79.37
HS6008	150	10.7	£221.09



22° LONG RADIUS BENDS

Product Code	Diameter (mm)	Nominal Weight (kg)	Price
HS4009	100	2.2	£61.18

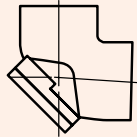

88° SHORT RADIUS BENDS WITH DOOR

Product Code	Diameter (mm)	Nominal Weight (kg)	Price
HS3010	70	2.5	£53.38
HS4010	100	3.8	£78.26

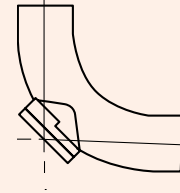

88° LONG RADIUS BENDS WITH DOOR

Product Code	Diameter (mm)	Nominal Weight (kg)	Price
HS4011	100	7.3	£101.12
HS6011	150	12.7	£254.47

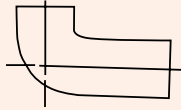

88° LONG TAIL BEND

Product Code	Diameter (mm)	Nominal Weight (kg)	Price
HS4013	100	4	£57.83



LONG TAIL BOSS BRANCH

Product Code	Diameter (mm)	Nominal Weight (kg)	Price
HS4059	100	TBA	£323.30



If you don't see a product within this brochure, we have the knowledge, experience and capability to manufacture bespoke castings and fabricated products to support our comprehensive standard ranges.

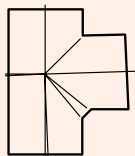

Please refer to our certificates for specific products covered.

**88° SINGLE EQUAL BRANCHES**

Product Code	Diameter (mm)	Nominal Weight (kg)	Price
HS2020	50 x 50	1.1	£39.75
HS3021	70 x 70	1.8	£42.19
HS4022	100 x 100	3.4	£53.26
HS6021	150 x 150	7.4	£128.06
HS8020	200 x 200	14	£341.33

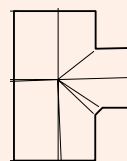
**88° SINGLE UNEQUAL BRANCHES**

Product Code	Diameter (mm)	Nominal Weight (kg)	Price
HS3020	70 x 50	1.5	£42.19
HS4020	100 x 50	2.2	£56.67
HS4021	100 x 70	2.5	£56.67
HS6020	150 x 100	5.1	£125.14

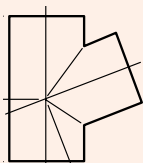
**69° SINGLE EQUAL BRANCHES**

Product Code	Diameter (mm)	Nominal Weight (kg)	Price
HS2023	50 x 50	1.1	£39.75
HS3024	70 x 70	1.8	£42.19
HS4025	100 x 100	3.4	£53.26

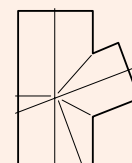
**69° SINGLE UNEQUAL BRANCHES**

Product Code	Diameter (mm)	Nominal Weight (kg)	Price
HS3023	70 x 50	1.4	£42.19
HS4023	100 x 50	2.1	£56.67
HS4024	100 x 70	2.6	£56.67
HS6023	150 x 100	4.9	£125.14

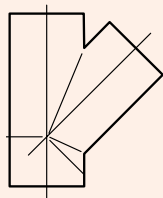
**45° SINGLE EQUAL BRANCHES**

Product Code	Diameter (mm)	Nominal Weight (kg)	Price
HS2026	50 x 50	1.3	£39.75
HS3027	70 x 70	2.2	£42.19
HS4028	100 x 100	4.3	£53.26
HS6027	150 x 150	10.2	£128.06
HS8028	200 x 200	16.8	£341.33

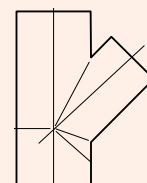
**45° SINGLE UNEQUAL BRANCHES**

Product Code	Diameter (mm)	Nominal Weight (kg)	Price
HS3026	70 x 50	1.8	£42.19
HS4026	100 x 50	2.4	£56.67
HS4027	100 x 70	3.1	£56.67
HS6028	150 x 70	4.9	£125.14
HS6026	150 x 100	5.8	£125.14
HS8026	200 x 100	9.1	£317.85
HS8027	200 x 150	13.2	£317.85



TECHNICAL
SUPPORT

If you need any assistance of a technical nature,
please feel free to give us a call.



SITE
SURVEYS

If you need us to visit a site, we're happy to oblige.
We can assist with working out quantities required
or any unusual requirements.

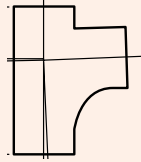

88° SINGLE RADIUS CURVE BRANCHES

Product Code	Diameter (mm)	Nominal Weight [kg]	Price
HS4030	100 x 100	4.1	£60.46
HS6030	150 x 100	6.5	£143.37
HS6033	150 x 150	11.7	£222.82

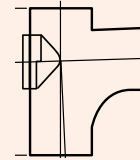

88° SINGLE RADIUS CURVE BRANCHES WITH DOOR

Product Code	Diameter (mm)	Nominal Weight [kg]	Price
HS4032	100 x 100	5.4	£100.59
HS6032	150 x 100	9.5	£216.89
HS6033	150 x 150	14.2	£222.82

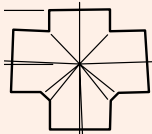

88° DOUBLE BRANCH

Product Code	Diameter (mm)	Nominal Weight [kg]	Price
HS4034	100 x 100	3.8	£76.97

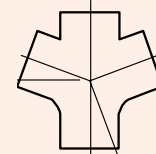

69° DOUBLE BRANCH

Product Code	Diameter (mm)	Nominal Weight [kg]	Price
HS4035	100 x 100	4.1	£76.97

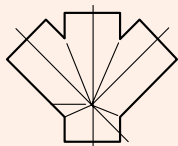

45° DOUBLE BRANCHES

Product Code	Diameter (mm)	Nominal Weight [kg]	Price
HS4036	100 x 100	5.7	£76.97
HS6036	150 x 100	6.5	£233.73
HS6037	150 x 150	11.7	£259.31
HS8036	200 x 200	21	£410.27

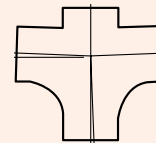

88° DOUBLE RADIUS CURVE BRANCHES

Product Code	Diameter (mm)	Nominal Weight [kg]	Price
HS4038	100 x 100	5.3	£75.57
HS6038	150 x 100	8.2	£241.71

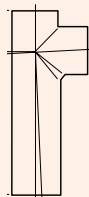

88° SINGLE LONG TAIL BRANCH

Product Code	Diameter (mm)	Nominal Weight [kg]	Price
HS4040	100 x 100	5.2	£185.88

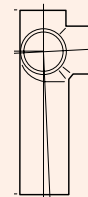

88° LONG TAIL CORNER BRANCH

Product Code	Diameter (mm)	Nominal Weight [kg]	Price
HS4041	100 x 100	7	£218.09

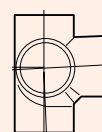

88° SHORT TAIL CORNER BRANCH

Product Code	Diameter (mm)	Nominal Weight [kg]	Price
HS4042	100 x 100	3.5	£138.69
Please refer to our certificates for specific products covered.			

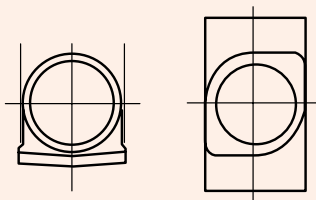
**ACCESS PIPES WITH ROUND DOOR**

Product Code	Diameter [mm]	Nominal Weight [kg]	Price
HS2043	50	1.7	£65.45
HS3043	70	2.5	£69.62
HS4043	100	4.3	£73.32
HS6043	150	7.9	£137.05

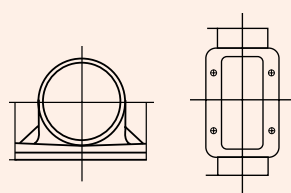
**ACCESS PIPES WITH RECTANGULAR DOOR**

Product Code	Diameter [mm]	Nominal Weight [kg]	Price
HS4049	100	7.2	£94.41
HS6049	150	13.5	£216.63
HS8049	200	22	£456.91

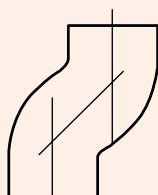
**OFFSETS 75MM PROJECTION**

Product Code	Diameter [mm]	Nominal Weight [kg]	Price
HS4044	100	2.6	£52.23

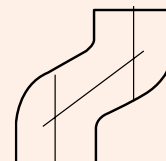
**OFFSETS 130MM PROJECTION**

Product Code	Diameter [mm]	Nominal Weight [kg]	Price
HS2045	50	1.4	£41.91
HS3045	70	2.3	£63.85
HS4045	100	3.8	£83.48

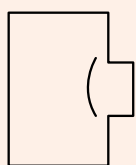
**BOSS PIPES SINGLE 2" BSPT**

Product Code	Diameter [mm]	Nominal Weight [kg]	Price
HS3053	70	1.6	£56.29
HS4053	100	2.1	£68.73
HS6053	150	3.6	£110.01

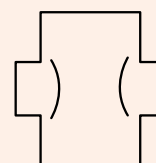
**BOSS PIPE 2 X 2" BSPT OPPOSED**

Product Code	Diameter [mm]	Nominal Weight [kg]	Price
HS4054	100	2.2	£80.82

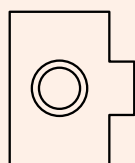
**BOSS PIPE 2 X 2" BSPT AT 90°**

Product Code	Diameter [mm]	Nominal Weight [kg]	Price
HS4055	100	2.2	£80.82

**PIPE TAPERS**

Product Code	Diameter [mm]	Nominal Weight [kg]	Price
HS3046	70 x 50	0.6	£36.10
HS4046	100 x 50	0.9	£44.78
HS4047	100 x 70	1.1	£44.78
HS6046	150 x 50	2.5	£85.17
HS6047	150 x 70	2.7	£85.17
HS6048	150 x 100	2.4	£85.17
HS8046	200 x 100	4	£139.24
HS8047	200 x 150	4	£139.24

TECHNICAL
SUPPORT

If you need any assistance of a technical nature,
please feel free to give us a call.

SITE
SURVEYS

If you need us to visit a site, we're happy to oblige.
We can assist with working out quantities required
or any unusual requirements.

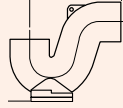

P TRAPS WITH BOTTOM DOOR

Product Code	Diameter (mm)	Nominal Weight (kg)	Price
HS2050	50	2.3	£92.60
HS3050	70	3.6	£92.60
HS4050	100	6.8	£99.93
HS6050	150	15.8	£179.46

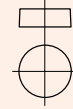

BLANK ENDS

Product Code	Diameter (mm)	Nominal Weight (kg)	Price
HS2051	50	0.2	£9.89
HS3051	70	0.4	£10.47
HS4051	100	0.8	£12.25
HS6051	150	1.6	£17.69
HS8051	200	2.9	£76.42

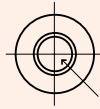

drilled & tapped
2" BSPT

BLANK ENDS DRILLED & TAPPED 2" BSPT

Product Code	Diameter (mm)	Nominal Weight (kg)	Price
HS4052	100	0.7	£27.43
HS6052	150	1.5	£33.54

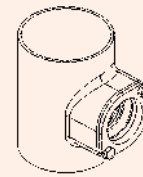

COMPRESSION FIT BOSS PIPES

Product Code	Diameter (mm)	Nominal Weight (kg)	Price
HS3090	75x50	2	£56.29
HS4090	100x50	2.5	£68.73
HS6090	150x50	4.2	£115.51

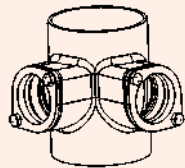

90° COMPRESSION FIT BOSS PIPE

Product Code	Diameter (mm)	Nominal Weight (kg)	Price
HS4091	100x50	3.2	£88.90

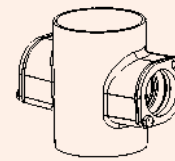

OPPOSED COMPRESSION FIT BOSS PIPES

Product Code	Diameter (mm)	Nominal Weight (kg)	Price
HS4092	100x50	3.2	£88.90

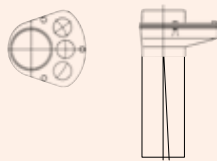

MANIFOLD CONNECTOR

Product Code	Diameter (mm)	Nominal Weight (kg)	Price
HS4058	100	3.5	£145.30

Manifold Connector fitted with 3 rubber plugs suitable for pushfit connection to 32mm/40mm diameter plastic/copper waste. Please check availability of 250mm and 300mm products.



P TRAPS (NO ACCESS)

Product Code	Diameter (mm)	Nominal Weight (kg)	Price
HS4080	100	4.6	£62.40



If you don't see a product within this brochure, we have the knowledge, experience and capability to manufacture bespoke castings and fabricated products to support our comprehensive standard ranges.

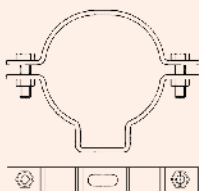

Please refer to our certificates for specific products covered.

**COATED ADJUSTABLE BRACKETS**

Product Code	Diameter [mm]	Nominal Weight [kg]	Price
HS2067	50	0.3	£13.90
HS3067	70	0.3	£13.90
HS4067	100	0.6	£15.90
HS6067	150	0.8	£29.58
HS8067	200	1.8	£109.63

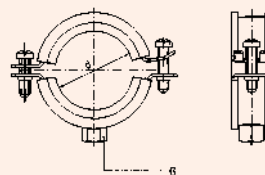
**ZINC PLATED RUBBER LINED BISMAT BRACKETS**

Product Code	Diameter [mm]	G	Price
HS2061	50	M8/M10	£5.82
HS3061	70	M10/M12	£7.91
HS4061	100	M10/M12	£11.26
HS6061	150	M10/M12	£21.99
HS8061	200	M10/M12	£32.78

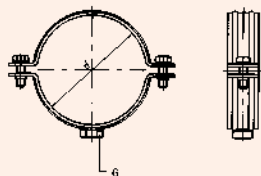
**ZINC PLATED HEAVY DUTY BOSSED BRACKETS**

Product Code	Diameter [mm]	G	Price
HS2063	50	M8/M10	£10.48
HS3063	70	M10/M12	£11.24
HS4063	100	M10/M12	£14.97
HS6063	150	M10/M12	£26.21
HS8063	200	M10/M12	£33.95

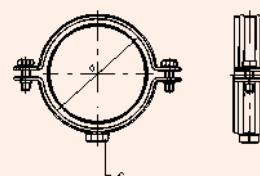
**ZINC PLATED RUBBER LINED HEAVY DUTY BOSSED BRACKETS**

Product Code	Diameter [mm]	G	Price
HS2064	50	M8/M10	£11.24
HS3064	70	M10/M12	£13.75
HS4064	100	M10/M12	£19.96
HS6064	150	M10/M12	£36.65
HS8064	200	M10/M12	£42.48

Please check availability of 250mm and 300mm products.

The Coated Adjustable Bracket may require a Wall Plate see 71. Threaded Bar not supplied.



TECHNICAL
SUPPORT

If you need any assistance of a technical nature,
please feel free to give us a call.



SITE
SURVEYS

If you need us to visit a site, we're happy to oblige.
We can assist with working out quantities required
or any unusual requirements.

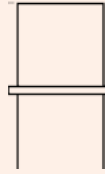

STACK SUPPORT PIPES

Product Code	Diameter (mm)	Nominal Weight (kg)	Price
HS3056	70	1.8	£53.82
HS4056	100	2.8	£59.45
HS6056	150	4.3	£94.13
HS8056	200	7.2	£138.58

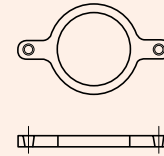

STACK SUPPORT BRACKETS WITH GASKET

Product Code	Diameter (mm)	Nominal Weight (kg)	Price
HS3057	70	1	£33.19
HS4057	100	1.4	£41.03
HS6057	150	1.8	£62.78
HS8057	200	2.2	£125.46

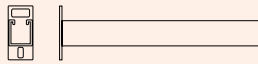

GALVANISED CANTILEVER ARMS

Product Code	Length (mm)	Strut (mm)	Price
HSD1830	300	41 x 41	£23.84
HSD1845	450	41 x 41	£31.17

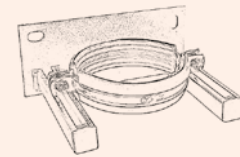

STACK SUPPORT CONSOLE WITH GUIDANCE CLAMP

Product Code	Diameter (mm)	Max Load (N)	Price
HS3070	70	3000	£100.71
HS4070	100	3000	£102.90
HS6070	150	3000	£111.63
HS8070	200	3000	£131.34

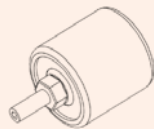

STAINLESS STEEL BRACKET DAMPNER 10MM

Product Code	Size (mm)	Nominal Weight (kg)	Price
HSD6703	M10	0.2	£68.24

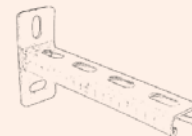

RAPID STRUT CANTILEVER ARM

Product Code	Length (mm)	Max Load (N)	Price
HSD1846	450	1881	£62.40

Please check availability of 250mm and 300mm products.



If you don't see a product within this brochure, we have the knowledge, experience and capability to manufacture bespoke castings and fabricated products to support our comprehensive standard ranges.



Please refer to our certificates for specific products covered.

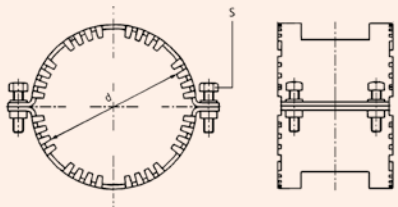

ZINC PLATED HALIFAX GRIPS

Product Code	Diameter (mm)	S	Price
HS2060	50	M8 x 30	£72.22
HS3060	70	M8 x 30	£73.88
HS4060	100	M8 x 30	£79.24
HS6060	150	M10 x 30	£118.59
HS8060	200	M10 x 30	£155.71

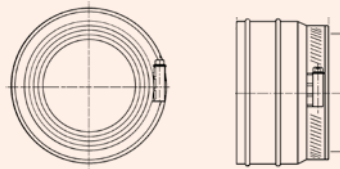

RUBBER HALIFAX FIX CONNECTORS

Product Code	Diameter (mm)	To Fit (mm)	Price
HS2068	50	40 - 56	£13.96
HS3068	70	56 - 75	£19.23
HS4068	100	104 - 110	£20.99

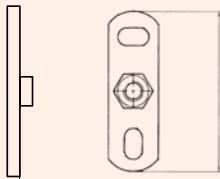

ZINC PLATED WALL PLATE

Product Code	Length (mm)	Bolt Size	Price
HSD6702	80	M10	£4.17



ZINC PLATED THREAD ADAPTER

Product Code	Male Thread	Female Thread	Price
HSD10/12	M10	M12	£4.22

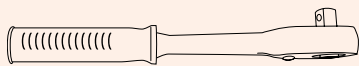

RATCHET SPANNER

Product Code	Drive (mm)	Price
HSD001	13	£108.50

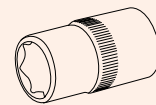

SOCKET (FOR ACCESS DOOR BOLTS)

Product Code	Diameter (mm)	Price
HSD002	13	£19.41

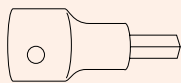

ALLEN SOCKET ADAPTERS (FOR COUPLINGS)

Product Code	Diameter (mm)	Price
HSD003	6	£26.68
HSD004	8	£27.45

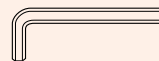

HEX ALLEN KEY (FOR COUPLING GRUB SCREW)

Product Code	Diameter (mm)	Price
HSD005	3	£0.99



If you need any assistance of a technical nature, please feel free to give us a call.



SITE SURVEYS

If you need us to visit a site, we're happy to oblige. We can assist with working out quantities required or any unusual requirements.

**PUSH FIT
COUPLINGS NOW
AVAILABLE**

Halifax Drain is a below ground socketless system and like Halifax Soil fully complies with BS EN 877:1999 + A1:2006 Incorporating Corrigendum 2008 and certified by BSI Kitemark (Cert No. KM 684754) and BBA (Cert No. 06/4401). These products have passed all the initial testing and rigorous on going testing to ensure the BS EN 877 is met. Independent testing is carried out on an annual basis. Our digital catalogue containing all technical, product and installation information is available at www.soilandrain.co.uk

Benefits

- Halifax Drain pipes are strong and highly resistant to shear loads
- Low risk of settlement damage
- Require less embedment and extra protection saving time and money
- High resistance to distortion and less likely to be damaged by vigorous rodding
- Long life expectancy (in excess of 100 years)
- Cast Iron is 100% recyclable and a sustainable material



EN877 HALIFAX DRAIN



Paint Finish

The Halifax Drain system pipes are lined internally with a two part grey epoxy finish which provides improved performance when exposed to aggressive substances. The pipes in this system are coated with an average dry film thickness of 170 microns. Pipes with an exterior coating in grey and interior coating in yellow have average dry film thicknesses of 130 microns and 170 microns respectively. Fittings are also epoxy coated in grey.

Halifax Drain coatings have been tested successfully for resistance to attack by salt spray, waste water, hot water cycling and solution of acid at PH2 and alkalis at PH12.

DRAIN PIPES & COUPLINGS, DRAIN CONNECTORS & TOOLS	98
DRAIN BENDS	99
DRAIN BRANCHES	100
DRAIN FITTINGS	101-102
DRAIN BRACKETS & CLAMPS	103

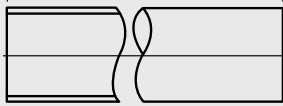

DOUBLE SPIGOT 3M PIPES

Product Code	Diameter (mm)	Nominal Weight (kg)	Price
HD4001	100	29.7	£157.91
HD6001	150	45.2	£310.78
HD8001	200	71.2	£520.16

Please check availability of 250mm and 300mm products.

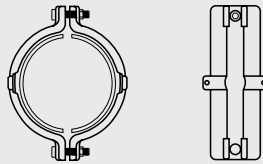

DUCTILE IRON COUPLINGS

Product Code	Diameter (mm)	Nominal Weight (kg)	Price
HD4012	100	1.1	£29.18
HD6012	150	2	£58.71
HD8012	200	3.5	£131.59

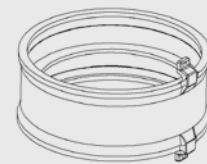

HALIFAX PUSH FIT COUPLINGS

Product Code	Diameter (mm)	Nominal Weight (kg)	Price
HD4095	100	1.5	£27.72
HD6095	150	2	£55.77

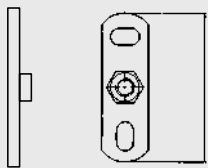

ZINC PLATED WALL PLATE

Product Code	Diameter (mm)	Nominal Weight (kg)	Price
HSD6702	80	M10	£4.17



ZINC PLATED THREAD ADAPTER

Product Code	Male Thread	Female Thread	Price
HSD10/12	M10	M12	£4.22



RATCHET SPANNER

Product Code	Drive (mm)	Price
HSD001	13	£108.50

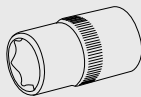

SOCKET (FOR ACCESS DOOR BOLTS)

Product Code	Diameter (mm)	Price
HSD002	13	£19.41



ALLEN SOCKET ADAPTERS (FOR COUPLINGS)

Product Code	Diameter (mm)	Price
HSD003	6	£26.68
HSD004	8	£27.45



If you need any assistance of a technical nature, please feel free to give us a call.



SITE SURVEYS

If you need us to visit a site, we're happy to oblige. We can assist with working out quantities required or any unusual requirements.

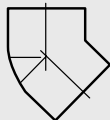

45° SHORT RADIUS BENDS

Product Code	Diameter (mm)	Nominal Weight (kg)	Price
HD4005	100	1.6	£39.34
HD6005	150	3.6	£68.45
HD8005	200	6.4	£203.72



30° SHORT RADIUS BENDS

Product Code	Diameter (mm)	Nominal Weight (kg)	Price
HD4006	100	0.8	£39.34
HD6006	150	1.1	£68.45



15° SHORT RADIUS BENDS

Product Code	Diameter (mm)	Nominal Weight (kg)	Price
HD4007	100	1.2	£39.34
HD6007	150	2.5	£68.45

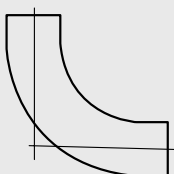

88° LONG RADIUS BENDS

Product Code	Diameter (mm)	Nominal Weight (kg)	Price
HD4008	100	5.3	£91.28
HD6008	150	10.7	£254.28



22° LONG RADIUS BENDS

Product Code	Diameter (mm)	Nominal Weight (kg)	Price
HD4009	100	2.2	£67.37

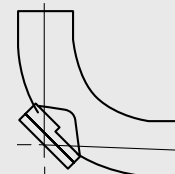

88° LONG RADIUS BENDS WITH DOOR

Product Code	Diameter (mm)	Nominal Weight (kg)	Price
HD4011	100	7.3	£116.26
HD6011	150	12.7	£279.92

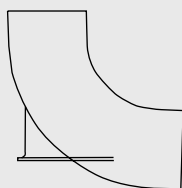

88° LONG RADIUS BENDS WITH HEEL REST

Product Code	Diameter (mm)	Nominal Weight (kg)	Price
HD4014	100	5.5	£111.20
HD6014	150	11.4	£273.37

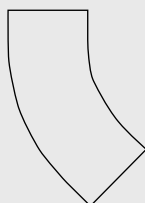

45° MEDIUM RADIUS BENDS

Product Code	Diameter (mm)	Nominal Weight (kg)	Price
HD4015	100	3.5	£64.41
HD6015	150	6.2	£141.17

Please check availability of 250mm and 300mm products.



If you don't see a product within this brochure, we have the knowledge, experience and capability to manufacture bespoke castings and fabricated products to support our comprehensive standard ranges.



Please refer to our certificates for specific products covered.

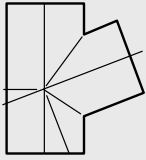

69° SINGLE EQUAL BRANCHES

Product Code	Diameter [mm]	Nominal Weight [kg]	Price
HD4025	100 x 100	3.4	£61.25

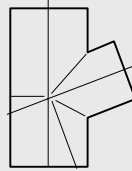

69° SINGLE UNEQUAL BRANCHES

Product Code	Diameter [mm]	Nominal Weight [kg]	Price
HD6023	150 x 100	4.9	£143.88

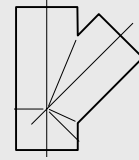

45° SINGLE EQUAL BRANCHES

Product Code	Diameter [mm]	Nominal Weight [kg]	Price
HD4028	100 x 100	4.3	£61.25
HD6027	150 x 150	10.2	£147.23
HD8028	200 x 200	16.8	£392.54

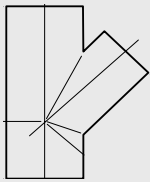

45° SINGLE UNEQUAL BRANCHES

Product Code	Diameter [mm]	Nominal Weight [kg]	Price
HD6026	150 x 100	5.8	£143.88
HD8026	200 x 100	9.1	£365.57
HD8027	200 x 150	13.2	£365.57

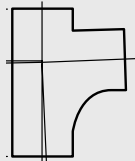

88° SINGLE RADIUS CURVE BRANCHES

Product Code	Diameter [mm]	Nominal Weight [kg]	Price
HD4030	100 x 100	4.1	£69.52
HD6030	150 x 100	6.5	£186.39
HD6031	150 x 150	11.7	£229.76

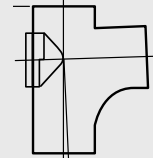

88° SINGLE RADIUS CURVE BRANCHES WITH DOOR

Product Code	Diameter [mm]	Nominal Weight [kg]	Price
HD4032	100 x 100	5.4	£120.73
HD6032	150 x 100	9.5	£238.59
HD6031	150 x 150	14.2	£229.76

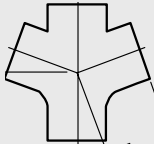

69° DOUBLE BRANCH

Product Code	Diameter [mm]	Nominal Weight [kg]	Price
HD4035	100 x 100	4.1	£88.51

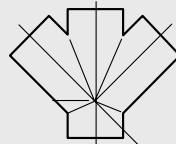

45° DOUBLE BRANCHES

Product Code	Diameter [mm]	Nominal Weight [kg]	Price
HD4036	100 x 100	5.7	£88.51
HD6036	150 x 100	6.5	£257.14
HD6037	150 x 150	11.7	£324.00
HD8036	200 x 200	21	£451.27

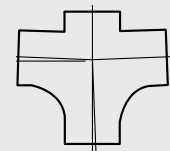

88° DOUBLE RADIUS CURVE BRANCHES

Product Code	Diameter [mm]	Nominal Weight [kg]	Price
HD4038	100 x 100	5.3	£86.90
HD6038	150 x 100	8.2	£293.14



If you need any assistance of a technical nature, please feel free to give us a call.



If you need us to visit a site, we're happy to oblige. We can assist with working out quantities required or any unusual requirements.

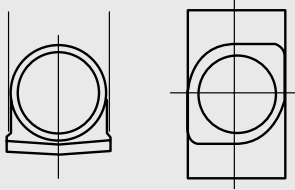

ACCESS PIPES WITH ROUND DOOR

Product Code	Diameter [mm]	Nominal Weight [kg]	Price
HD4043	100	3.4	£84.26
HD6043	150	7.9	£150.74

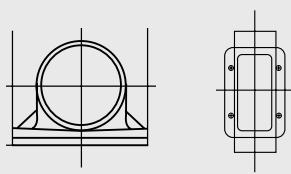

ACCESS PIPES WITH RECTANGULAR DOOR

Product Code	Diameter [mm]	Nominal Weight [kg]	Price
HD4049	100	7.2	£118.08
HD6049	150	13.5	£259.93
HD8049	200	22	£532.84

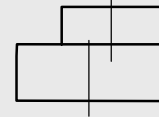

PIPE TAPERS

Product Code	Diameter [mm]	Nominal Weight [kg]	Price
HD6048	150 x 100	2.4	£93.67
HD8046	200 x 100	4	£160.10
HD8047	200 x 150	4	£160.10

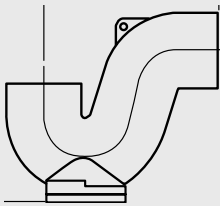

P TRAPS WITH BOTTOM DOOR

Product Code	Diameter [mm]	Nominal Weight [kg]	Price
HD4050	100	6.8	£114.96
HD6050	150	15.8	£206.37



P TRAPS (NO ACCESS)

Product Code	Diameter [mm]	Nominal Weight [kg]	Price
HD4080	100	4.6	£74.30

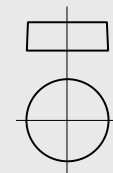

BLANK ENDS

Product Code	Diameter [mm]	Nominal Weight [kg]	Price
HD4051	100	0.8	£14.13
HD6051	150	1.6	£20.34
HD8051	200	2.9	£87.91

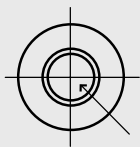

drilled & tapped
2" BSPT

BLANK ENDS DRILLED & TAPPED 2" BSPT

Product Code	Diameter [mm]	Nominal Weight [kg]	Price
HD4052	100	0.7	£30.17
HD6052	150	1.5	£36.84

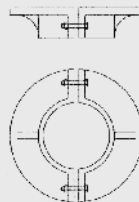

PUDDLE FLANGES

Product Code	Diameter [mm]	Nominal Weight [kg]	Price
HD4078	100	4	£98.68
HD6078	150	6	£117.54
HD8078	200	7	£153.69



If you don't see a product within this brochure, we have the knowledge, experience and capability to manufacture bespoke castings and fabricated products to support our comprehensive standard ranges.



Please refer to our certificates for specific products covered.

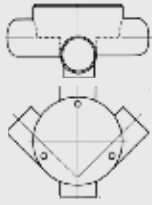

ROUND 2 BRANCH INSPECTION CHAMBER

Product Code	Diameter (mm)	Nominal Weight (kg)	Price
HD4480	100 x 100	15.9	£397.18
HD6480	150 x 100	18.9	£476.60
HD6680	150 x 150	19.4	£593.06

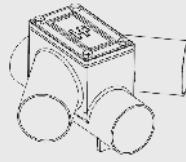

RECTANGULAR 2 BRANCH INSPECTION CHAMBER

Product Code	Diameter (mm)	Nominal Weight (kg)	Price
HD4481	100 x 100	10.2	£454.42
HD6481	150 x 100	14.9	£588.51
HD6681	150 x 150	18	£737.51

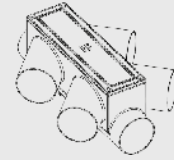

RECTANGULAR 4 BRANCH INSPECTION CHAMBER

Product Code	Diameter (mm)	Nominal Weight (kg)	Price
HD4482	100 x 100	18.6	£901.39
HD6482	150 x 100	25.8	£1,199.36
HD6682	150 x 150	31.2	£1,482.43

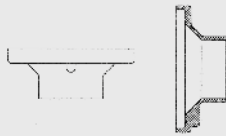

BELLMOUTH GULLY INLET

Product Code	Diameter (mm)	Nominal Weight (kg)	Price
HD4070	100	2.4	£71.21

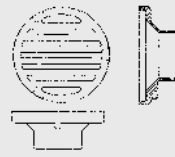

BELLMOUTH GULLY INLET WITH SECURED GRATING

Product Code	Diameter (mm)	Nominal Weight (kg)	Price
HD4071	100	4.7	£95.43

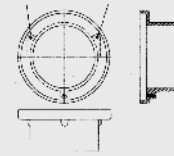

GULLY INLET

Product Code	Diameter (mm)	Nominal Weight (kg)	Price
HD6071	150	2.9	£98.82

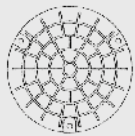

SOLID COVER WITH RUBBER SEAL & SCREWS

Product Code	Diameter (mm)	Nominal Weight (kg)	Price
HD8076	200	2.2	£30.57



PLAIN GRATING

Product Code	Diameter (mm)	Nominal Weight (kg)	Price
HD8077	200	1.8	£17.18



TECHNICAL
SUPPORT

If you need any assistance of a technical nature,
please feel free to give us a call.



SITE
SURVEYS

If you need us to visit a site, we're happy to oblige.
We can assist with working out quantities required
or any unusual requirements.

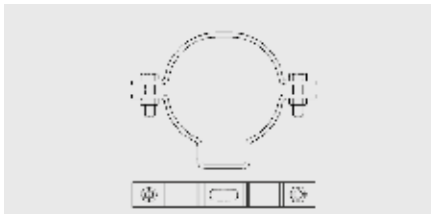

COATED ADJUSTABLE BRACKETS			
Product Code	Diameter (mm)	Nominal Weight (kg)	Price
HD4067	100	0.6	£17.47
HD6067	150	0.8	£32.53
HD8067	200	1.8	£120.60

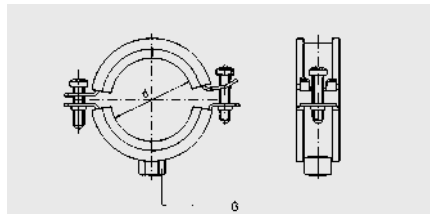

ZINC PLATED RUBBER LINED BISMAT BRACKETS			
Product Code	Diameter (mm)	Nominal Weight (kg)	Price
HS4061	100	M8/M10	£11.26
HS6061	150	M10	£21.99
HS8061	200	M10	£32.78

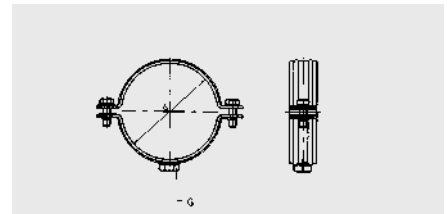

ZINC PLATED HEAVY DUTY BOSSED BRACKETS			
Product Code	Diameter (mm)	Nominal Weight (kg)	Price
HS4063	100	M10/M12	£14.97
HS6063	150	M10/M12	£26.21
HS8063	200	M10/M12	£33.95

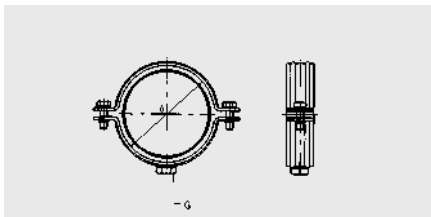

ZINC PLATED RUBBER LINED HEAVY DUTY BOSSED BRACKETS			
Product Code	Diameter (mm)	Nominal Weight (kg)	Price
HS4064	100	M10/M12	£19.96
HS6064	150	M10/M12	£36.65
HS8064	200	M10/M12	£42.48

Please check availability of 250mm and 300mm products.



If you don't see a product within this brochure, we have the knowledge, experience and capability to manufacture bespoke castings and fabricated products to support our comprehensive standard ranges.



Please refer to our certificates for specific products covered.



These individual pieces of contemporary street art are also functional pieces of street furniture. They are made exclusively at Hargreaves Foundry and are individually numbered and sold with a certificate of authenticity.

SIR ANTONY GORMLEY BOLLARDS

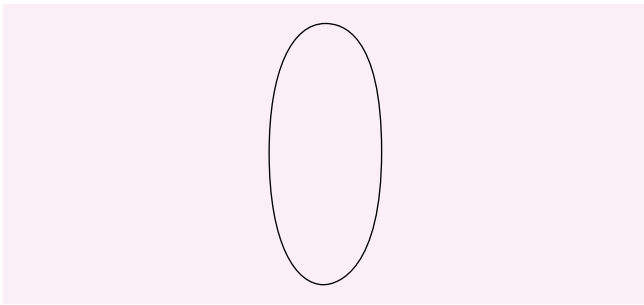

ANTONY GORMLEY BOLLARD OVAL				
Part Number	Diameter [mm]	Height [mm]	Root [mm]	Price
170A	240	1000	300	POA

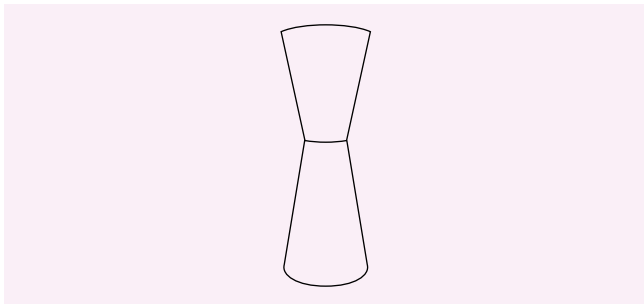

ANTONY GORMLEY BOLLARD PEG				
Part Number	Diameter [mm]	Height [mm]	Root [mm]	Price
170B	345	1000	300	POA

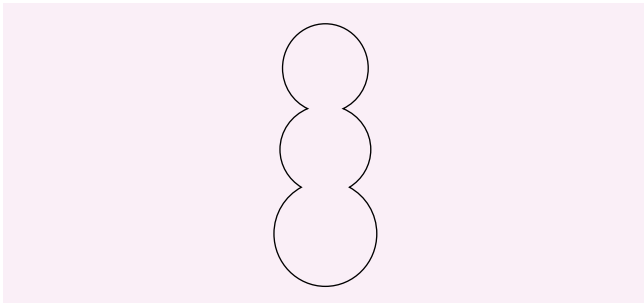

ANTONY GORMLEY BOLLARD SNOWMAN				
Part Number	Diameter [mm]	Height [mm]	Root [mm]	Price
170C	400	1000	300	POA

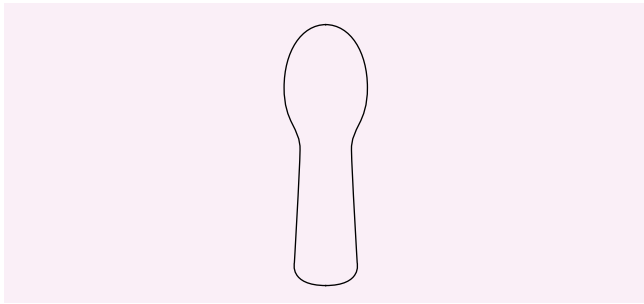

ANTONY GORMLEY BOLLARD PENIS				
Part Number	Diameter [mm]	Height [mm]	Root [mm]	Price
170D	330	1000	300	POA

Cast with fixing root. Supplied in oxidised iron finish.



Our street furniture range includes classic and popular designs. Cast iron is an excellent choice for any location offering strength, proven track record and sustainability.

Our street furniture castings are supplied in a two pack, gloss coat finish. We can also offer different colour choices, lettering and other embellishments, please enquire for details.

Pre painting offers quicker installation and no requirement for hazardous materials on site.

We only purchase wood for our benches from managed and sustainable sources through our suppliers who are able to prove the supplies product authenticity via approved forest management schemes. Further information about this can be obtained through our technical department.

STREET FURNITURE



STREET FURNITURE & EXTRAS	106
SEATING & BINS	107
GRATES & FRAMES	108
AIR BRICKS	109

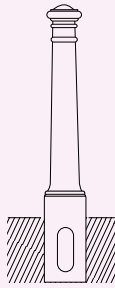

MANCHESTER BOLLARD

Part Number	Diameter [mm]	Height [mm]	Root [mm]	Price
004	200	1000	300	£275.56

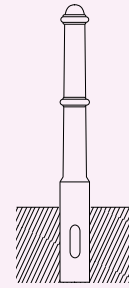

STANDARD CANNON BOLLARD

Part Number	Diameter [mm]	Height [mm]	Root [mm]	Price
009	170	1200	350	£253.23

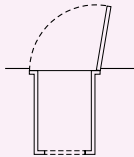

Bollard requires eyebolts to allow locking - POA.

SOCKET FOR REMOVEABLE BOLLARD

Part Number	Diameter [mm]	Height [mm]	Root [mm]	Price
039A	272	272	322	£253.98

Bollards can be supplied with eyebolts for use with padlocks or chains - POA. Hazard banding can be applied - POA.

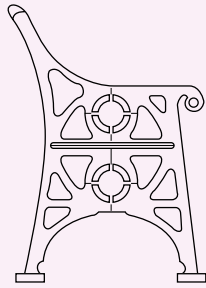
**EASTGATE BENCH**

Part Number	Length [mm]	Depth [mm]	Height [mm]	Price
412A	1800	590	840	£1,186.93

EASTGATE SEAT END LH

Part Number	Length [mm]	Depth [mm]	Height [mm]	Price
412LH	-	590	840	£225.07

EASTGATE SEAT END RH

Part Number	Length [mm]	Depth [mm]	Height [mm]	Price
412RH	-	590	840	£225.07

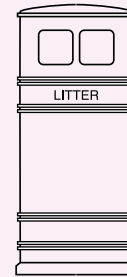
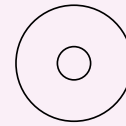

Lettering is highlighted in gold unless otherwise specified.

HERITAGE LITTER BIN 415MM DIA 940MM WITH LINER & KEY

Part Number	Diameter [mm]	Height [mm]	Price
307	415	940	£1,296.17

LARGE HERITAGE LITTER BIN 560MM DIA 950MM LINER & KEY

Part Number	Diameter [mm]	Height [mm]	Price
309	560	950	£1,546.22

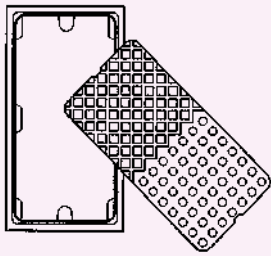
**DEEP BUCHAN FRAME & COVER 53MM DEPTH**

Part Number	Size [mm]	Price
BCF300D	300 x 150	£40.15

SHALLOW BUCHAN FRAME & COVER 33MM DEPTH

Part Number	Size [mm]	Price
BCF300S	300 x 150	£40.15

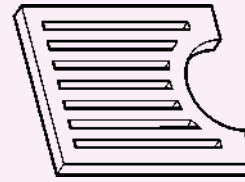
**75MM GULLEY GRATE**

Part Number	Size [mm]	Price
GG03	135 x 160 (to fit up to 75mm diameter pipe)	£12.95

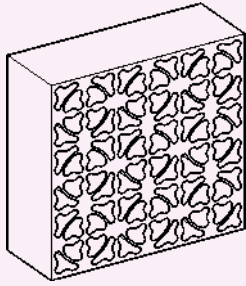

225X75MM AIR BRICK IN PRIMER FINISH

Part Number	Width [mm]	Height [mm]	Depth [mm]	Price
AB0903	225	75	75	£54.57

225X150MM AIR BRICK IN PRIMER FINISH

Part Number	Width [mm]	Height [mm]	Depth [mm]	Price
AB0906	225	150	75	£66.22

225X225MM AIR BRICK IN PRIMER FINISH

Part Number	Width [mm]	Height [mm]	Depth [mm]	Price
AB0909	225	225	75	£71.55

230X75MM AIR BRICK PX IN PAINTED BLACK FINISH

Part Number	Width [mm]	Height [mm]	Depth [mm]	Price
XAB0903	225	75	75	£68.76

230X150MM AIR BRICK PX IN PAINTED BLACK FINISH

Part Number	Width [mm]	Height [mm]	Depth [mm]	Price
XAB0906	225	150	75	£83.40

230X230MM AIR BRICK PX IN PAINTED BLACK FINISH

Part Number	Width [mm]	Height [mm]	Depth [mm]	Price
XAB0909	230	230	75	£90.16

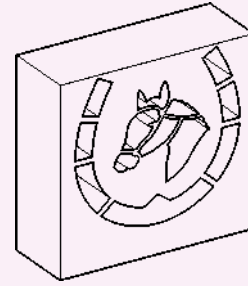

230X230MM HORSE AIR BRICK IN PRIMER FINISH

Part Number	Width [mm]	Height [mm]	Depth [mm]	Price
ABH0909	230	230	75	£121.14

230X230MM HORSE AIR BRICK PX IN PAINTED BLACK FINISH

Part Number	Width [mm]	Height [mm]	Depth [mm]	Price
XABH0909	230	230	75	£152.69

FAQ's...

Q. WHAT ARE THE BENEFITS OF CAST IRON?

A. Cast Iron is robust and durable offering a 'fit and forget' drainage solution; over time it will retain its shape, alignment, cosmetic appearance and water discharge function. The unrivalled life span combined with low maintenance requirements makes a Cast Iron system cost effective compared to other materials. Many listed buildings require genuine Cast Iron for refurbishment; replica systems cannot retain the strength, character and integrity of an original system. Further details of the benefits of Cast Iron can be downloaded from www.hargreavesdrainage.com or emailed on request.

Q. WHAT ARE THE LIFE EXPECTANCY AND MAINTENANCE REQUIREMENTS OF CAST IRON?

A. Cast Iron offers longevity for rainwater, soil or drainage solutions; installations have been proven to last well in excess of 100 years. Minimal maintenance is required for Hargreaves castings, annual inspections are recommended but if systems are correctly installed, only periodic painting should be required.

Q. I NEED AN UNUSUAL PRODUCT THAT I CAN'T FIND IN THE BOOK, CAN YOU MAKE IT FOR ME?

A. Yes. Unique castings can be created by our skilled craftsmen to bespoke designs for special requirements. Made to order castings can include radius gutters or ornamental rainwater heads. All standard products can be altered to exact specifications: extended offsets, unusual angles and special bracketry for example can be catered for by our in house fabricators.

Q. I AM UNSURE OF THE PARTS I NEED, CAN YOU ADVISE ME?

A. Yes, our contracts office can offer a drawing take off service or site survey where required. Drainage calculations can be completed on your behalf to identify the optimum size for your rainwater, soil or drainage system.

Q. I WOULD LIKE SOME INSTALLATION ADVICE, CAN YOU HELP?

A. Yes. Our experienced sales team can answer many frequently asked questions related to the installation of our products; our technical team can offer additional support. We have a number of specific installation data sheets which can be emailed on request. Hargreaves Drainage catalogues also provide general installation guidance; these can be downloaded at www.hargreavesdrainage.com

Q. CAN I OPEN AN ACCOUNT?

A. Hargreaves Drainage supply through a network of merchants and therefore accounts cannot be opened for contractors, installers or private individuals. Merchants and distributors can contact our sales office to request an account application form, applications are subject to approval.

Q. CAN I HAVE MY ORDER DELIVERED TO A DIFFERENT ADDRESS?

A. Yes. Hargreaves Drainage offers a direct to site delivery service. We will need a full site address including postcode and a site contact name and telephone number. You will also need to provide details of any site access restrictions, special offload or booking in requirements and site opening hours.

T&C's

HARGREAVES FOUNDRY DRAINAGE LIMITED GENERAL CONDITIONS OF PURCHASE

Definitions: in these conditions "the Company" shall mean Hargreaves Foundry Drainage Limited, "the Goods" shall mean the product supplied by the Company, and "the Customer" shall mean the company, firm or person buying the goods from the Company.

1. Application of Conditions

Refer to www.hargreavesfoundry.co.uk.

These terms and conditions govern the supply of goods sold by Hargreaves Foundry Drainage Ltd. (3428346) of Water Lane, South Parade, Halifax, West Yorkshire HX3 9GH (Seller) to the customer (Buyer). This enclosed document General Condition of Purchase, and Terms and Conditions constitute a legally binding contract between both parties.

2. Quotations

All quotations given by the Company are subject to acceptance by the Company on receipt of the Customer's order and a contract will only be formed when the Company has accepted the Customer's order. All such acceptances by the Company are subject to the availability of the necessary materials and to the Company being able to obtain any necessary authorisation and/or licences and to the same remaining valid. Whenever the Company is requested by the customer to give a series of quotations within the same contract, each and every quotation is to be construed as the subject of a separate agreement and the provision of this clause will apply to each quotation given by the Company. Lead times are quoted in working days. The Company reserves the right not to supply goods to individual contracts without instructions referring to the contract quotation.

3. Accuracy of Description of Goods

The Company have made every effort to ensure that the information contained in any publication is, to its knowledge, accurate at the time of print. The Company does not accept any responsibility for any errors within its literature. The Company strives for continuously improve its products and therefore reserves the right to change, without prior notice, any of the data contained in its publication.

4. Prices & VAT

All prices quoted are the Company's current prices at the time of quotation and are net ex works and exclusive of VAT which shall be added at the rate in force at the time the Goods are invoiced, where applicable unless otherwise stated. The price payable for the goods shall be the price ruling at the date of despatch and the Company shall be entitled to adjust the price of the goods at any time between the date of confirmation of order and the date of delivery of the goods, to take account of any increase in costs incurred by the Company or changes to its price lists. Special orders and non-standard colours may be subject to a manufacturer's premium; such premium will be detailed on each individual quotation.

5. Delivery

Despatch shall be deemed to have been effected when the goods leave the Company's premises. Time for delivery is not of the essence and the Company shall not be liable for any loss or damage caused by late delivery or by non-delivery. If you have not received the goods (to designated time frame) then you should notify us immediately.

6. Haulage Charges

Haulage charges will be calculated on an individual basis and will be levied in line with the Company's policy in force at the date of despatch. Small loads or express deliveries will be charged on an individual basis.

7. Payment Account

Customer's shall be invoiced including VAT, and payable due on the 30th day of the month following the month of delivery, or to specific pre-arranged

agreement. If payment is not made when due, interest is payable at the rate of 4% above the minimum lending rate of Barclays Bank PLC.

8. Termination

The Company may suspend supply or delivery. Stop any goods in transit or terminate our contract by notice in writing to you if you are in breach of obligation hereunder or you become unable to pay your debt when they fall due or proceedings are commenced by or against you alleging bankruptcy or insolvency. Upon termination, your indebtedness to us becomes immediately due and payable and we shall be under no further obligation to supply goods to you.

9. Risk

Risk in each consignment of the Goods or in each consignment of the Goods where the Company has elected to make deliveries by instalment pursuant to Delivery Clause shall pass to the Customer when the Goods are delivered or collected by the Customer or its agent.

10. Property

Notwithstanding the passing of risk under Clause 9 above, unless and until payment shall have been made to the Company in respect of all the Goods delivered or to be delivered to the Customer and comprised in the contract and in respect of all and any Goods supplied or to be supplied by the Company under this contract or under any other contract between the customer and the Company in accordance with Clause 8, property in an title in such Goods shall remain with the Company.

10A. Patterns

The company retains ownership and rights to reproduce all patterns.

11. Inspection/Shortages

The Customer shall inspect the Goods on delivery or on collection as the case may be. In all cases where the Customer complains of defects or shortages, the Company shall without prejudice to the question of liability generally be under no liability in any event if it has not been given an opportunity to inspect the goods before they have been used by the Customer. In respect of damage to all or part of the Goods or loss of part of the Goods comprised in the Contract notification must be made to the Company within 5 working days of delivery of the Goods (which will normally be stated on the Carrier's consignment note) and separately to the Carrier within the period stipulated by the Carrier's terms of carriage for claims against the Carrier.

12. Warranty

The Company warrants that it has title to and the right to sell the goods. No representation or warranty is given by the Company as to the suitability or fitness of the Goods for any particular purpose and the Customer shall satisfy him in this respect and shall be totally responsible therefore.

13. Liability/Exclusions

Upon notification of a problem with the goods, we will either make good any shortage or non-delivery; replace or repair any goods that are damaged or defective upon delivery; or resolve the financial element of the cost of material. We will not be liable to you for any loss of profit, administrative inconvenience, disappointment, indirect or consequential loss or damage arising from any problem in relation to the goods and we shall have no liability to pay any money to you by way of compensation other than any refund we make under these conditions. This does not affect your statutory rights as a consumer, nor is it intended to exclude our liability to you for fraudulent misrepresentation or for death or personal injury resulting in our negligence.

14. Indemnity

The Customer shall keep the Company indemnified against all costs, claims, demands, expenses and liabilities of whatsoever nature made by third

parties caused in whole or in part or arising out of any act or omission of the customer in connection with the use or storage or sale of the Goods.

15. Design etc

Where the goods are made to a specification, instruction, or design supplied on or on behalf of the Customer; the Customer is responsible for the suitability and accuracy of the specification, instruction, design or drawing (even where finally produced by the Company); the Customer shall indemnify the Company against infringement of any third party's intellectual property rights in the specification, instruction, design or drawing. Copyright, design, right and any other intellectual property rights in the drawings, designs and the like prepared by or for the Company vests in the Company and the Customer undertakes not to copy any Goods supplied by the Company.

16. Assignment

The Customer shall not assign nor transfer nor purport to assign or transfer any contract to which these conditions apply or the benefit thereof to any other Company or person whatsoever.

17. Force Majeure

The Company shall have no liability for any failure to perform, for any delay in the performance of any obligations under the Contract arising wholly or in part by reason of any factor beyond its direct control.

18. Cancellation

Orders may only be cancelled with the consent of the Company. Cancellation will not be accepted where the goods have been made/painted to order, or are bespoke products. In the event of cancellation the Customer will indemnify the Company fully against all expenses incurred by the Company together with liquidated damages of 25% of the contract price.

19. Returns

Goods returned to the Company will be accepted only at the Company discretion. In the event of returns being accepted, a restocking charge will apply, this does not include delivery back to the Company. For further details and restocking charges see Returns Policy on www.hargreavesfoundry.co.uk

20. Time and Indulgence

The whole rights and remedies of the Company in terms of these conditions shall not be prejudiced or derogated from in any way by the failure of the Company whether on one or more occasion to exercise any of said rights and remedies, or by its agreement whether on one or more occasion not to exercise any of said rights and remedies.

21. Severability

In the event that any part of these conditions shall be determined to be invalid, unlawful or unenforceable to any extent such condition or provision shall be severed from the remaining conditions which shall continue to be valid and enforceable to the fullest extent permitted by law.

22. Notices

Any notice, consent, notification, acknowledgement, authority or agreement required or referred to in the contract shall be: In writing and given to the party for whom it is intended at their registered or main office or last known address, and Given by registered or recorded delivery post, e-mail or telefax and shall be deemed to have been received 5 days after posting or 1 day after transmission as the case may be.

23. Jurisdiction

All contracts between the Company and the Customer shall be governed and be construed in accordance with English Law and all disputes arising in relation to such contracts shall be submitted to the jurisdiction of the English courts.

Disclaimer

Hargreaves Drainage has made every effort to ensure that the information contained in this publication is, to the best of our knowledge, accurate at the time of print. The company does not accept any responsibility for any errors within this literature.

We strive to continuously improve our products and therefore reserve the right to change, without prior notice, any of the data contained in this publication. The customer is responsible for ensuring that each product is fit for its intended purpose and that conditions are suitable; all guidance regarding the use of products is made without guarantee.

HW-1-01/09/13



LET'S GET CONNECTED!



KEEP UP TO DATE WITH NEW PRODUCTS, EVENTS AND NEWS

HARGREAVES FOUNDRY DRAINAGE | WATER LANE | HALIFAX | WEST YORKSHIRE | HX3 9HG

T: 01422 330607 | F: 01422 320349 | E: sales@hargreavesfoundry.co.uk | W: www.hargreavesfoundry.co.uk