

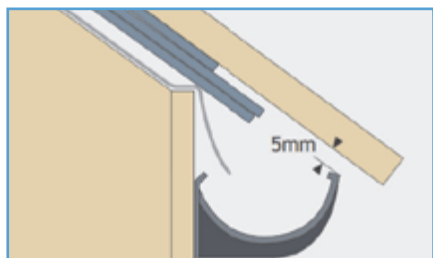

## Cast iron rainwater system

Cast iron gutters are available in a choice of four profiles with a range of brackets to accommodate all types of eaves condition. Each profile range can be connected to cast iron pipework systems in either round, square or rectangular. Assembly and installation of each profile range must be considered individually, although general aspects of preparation are common to them all as shown below.



1. Using a straight edge or ruler, shim gutter brackets with 5mm clearance so that the last roof tile or slate will align with the mid point of the gutter.

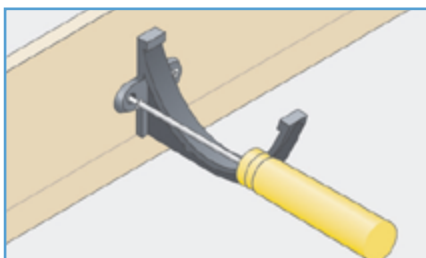

2. Generally, position brackets at 915mm centres allowing additional brackets either side of where gutter joints will occur.

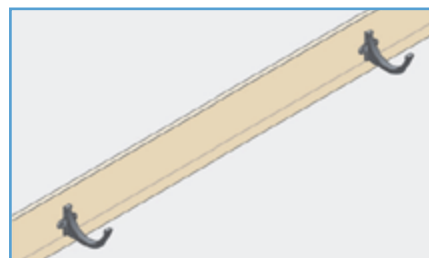

3. Use a string line to set out brackets to a fall of 1:600 to 1:350 (max) or if not possible, level.

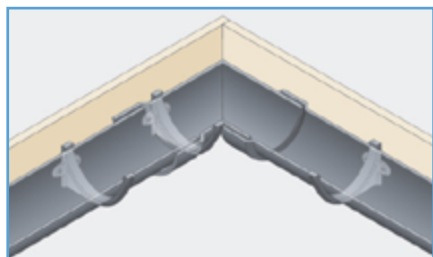

4. Plumb line outlets with gullies at ground level. Position angles, allowing an additional bracket adjacent to the joint with the gutter length.

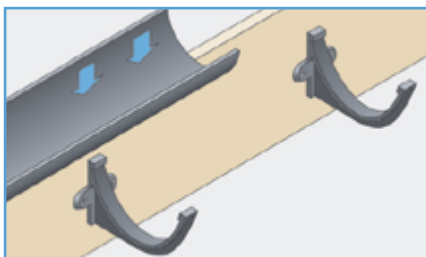

5. Lower the gutter onto the brackets ensuring sufficient clearance for the gutter joint. Clip gutter into bracket.

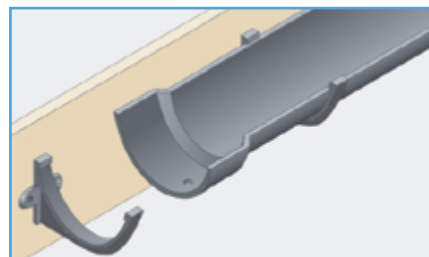

6. Cast gutters overlap at the joint with a spigot and socket. Thoroughly clean and degrease the ends that must be jointed.

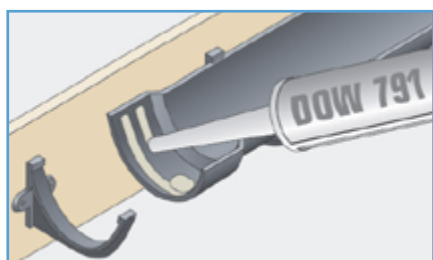

7. Apply two 6mm beads of DOW 791 silicone sealant either side of, and around the fixing hole.

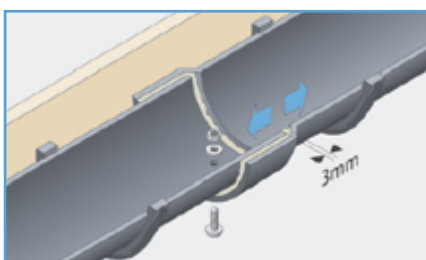

8. Insert the spigot end of the gutter allowing a 3mm expansion gap. Secure joint using bright zinc plated, mild steel M6 x 25mm nut, bolt and washer provided. (Bolt head preferably to underside).

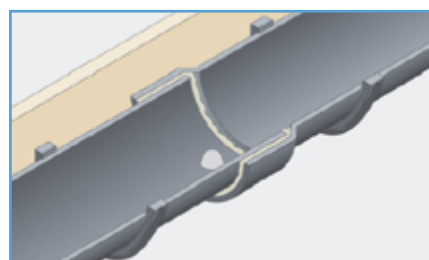

9. Finally, cone-off the exposed bolt stud and nut inside the gutter with a generous application of silicone sealant. Tool off excess silicone around the joint and from external surfaces.

### Hydrostrip Alternative Sealing Method

For half round gutters only (nominal sizes 100, 115 and 125mm - 150mm), the Rainclear Hydrostrip system is recommended. The Hydrostrip system comprises preformed rubber seals that are quick and easy to install, and totally reliable. Hydrostrip offers a faster and cleaner solution to gutter jointing than traditional mastic jointing sealants.

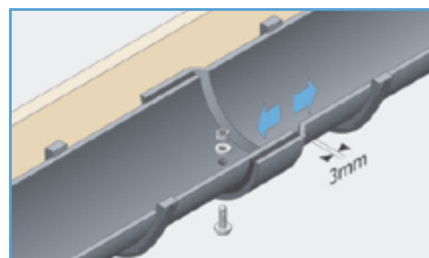
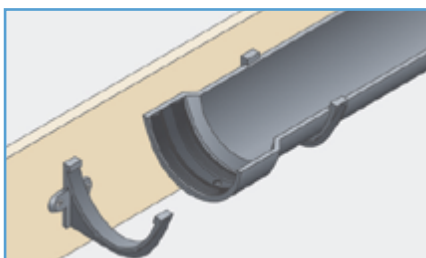



Rainclear traditional rainwater pipes have cast pipe sockets either with ears for wall fixing or without for use with holderbats. Installation is generally from the eaves downward saw cuts must be square and free from dents and burrs. A light application of silicone sealant must be applied to both surfaces to ensure a waterproof seal.

### Pipe Alignment

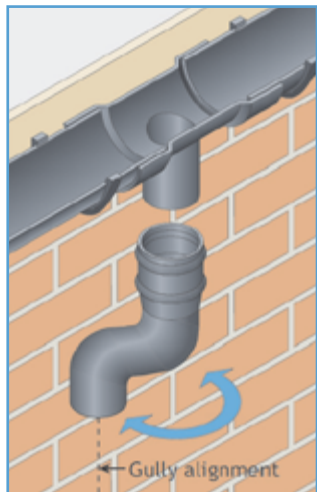

Where square or rectangular pipes are being installed and offsets are required, alignment between the gutter outlet and gully must be exact.

Round pipe systems are more flexible to install and offsets can be adjusted and "swung" into alignment with the gully position.

### Outlets and Offsets

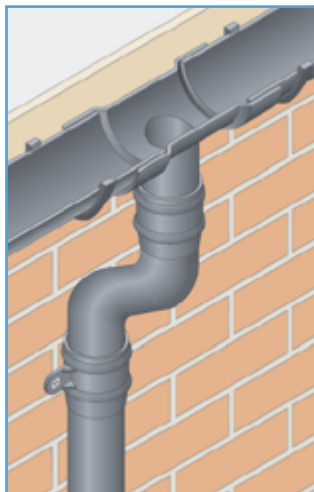

Commence installation from the gutter outlet by fitting offsets. Check vertical plumb line positioning and seal spigot and socket joints using DOW 791 silicone sealant.

### Pipe Jointing and Fixing

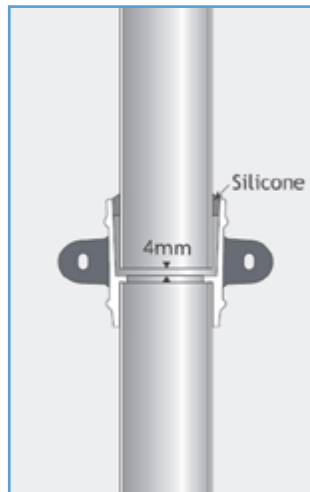

Seal with DOW 791 silicone sealant. Fix to wall at 2m centres using No12 x 50mm screws. Eared sockets have elongated fixing holes to permit the use of pipe nails.

### Tools Required

- String or plumb line
- Tape measure
- Drill
- File
- Masonary bit
- Wall fixing (e.g. raw plug)
- Cleaning rags
- Marker pen
- Solvent cleaner
- Posi and plain screwdriver
- Paintbrush
- Hacksaw
- Masking tape
- Mastic Gun
- Spirit level
- Protective gloves
- Adjustable spanner

### General Installation Sequence

- Complete installation of gutters; alternatively, locate rainwater heads
- Position offsets, bends and branches
- Fit pipes and brackets
- Fit plinth offsets
- Fit access doors and shoes

### Bends and Branches

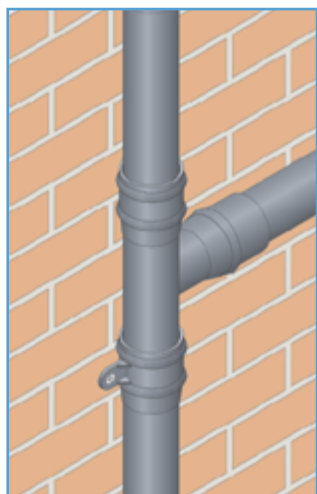

Bends and branches are secured into the pipe socket.

### Shoes and Access Pipes

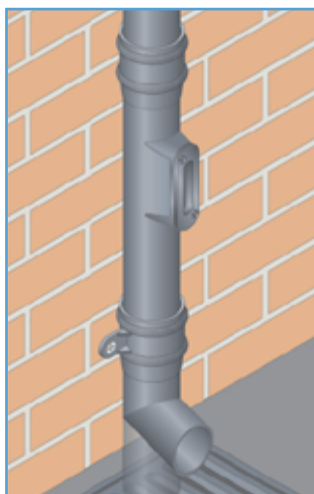

### Sealant

For durable all weather seals and best results, Rainclear recommend the use of DOW 791 silicone sealant.

### Rainwater Heads

Fix to masonry through external lugs or preformed holes in back.

